



 1990 Service Manual
First Edition

Global (Excl. Canada & USA)

Downloaded from Canadian Prelude Club

PRELUDE
INFAMOUZ

INTRODUCTION

How to Use This Manual

This supplement contains information for the 1990 PRELUDE. Refer to following shop manual for service procedures and data not included in this supplement.

Description	Code No.
PRELUDE CHASSIS Maintenance and Repair 88	62SF100
PRELUDE SUPPLEMENT 89	62SF120
B20A ENGINE Maintenance and Repair	62PK100
H2 MANUAL TRANSMISSION Maintenance and Repair	62PX500
K4 AUTOMATIC TRANSMISSION Maintenance and Repair	62PK400

The first page of each section is marked with a black tab that lines up with one of the thumb index tabs on this page. You can quickly find the first page of each section without looking through a full table of contents. The symbols printed at the top corner of each page can also be used as a quick reference system.

Special Information

▲ WARNING Indicates a strong possibility of severe personal injury or loss of life if instructions are not followed.

CAUTION: Indicates a possibility of personal injury or equipment damage if instructions are not followed.

NOTE: Gives helpful information.

CAUTION: Detailed descriptions of *standard* workshops procedures, safety principles and service operations are not included. Please note that this manual does contain warnings and cautions against some specific service methods which could cause **PERSONAL INJURY**, or could damage a vehicle or make it unsafe. Please understand that these warnings cannot cover all conceivable ways in which service, whether or not recommended by Honda Motor, might be done, or of the possible hazardous consequences of each conceivable way, nor could Honda Motor investigate all such ways. Anyone using service procedures or tools, whether or not recommended by Honda Motor, *must satisfy himself thoroughly* that neither personal safety nor vehicle safety will be jeopardized.

All information contained in this manual is based on the latest product information available at the time of printing. We reserve the right to make changes at any time without notice. No part of this publication may be reproduced, stored in retrieval system, or transmitted, in any form by any means, electronic, mechanical, photocopying, recording, or otherwise, without the prior written permission of the publisher. This includes text, figures and tables.

Sections are not included in this manual.

First Edition 3/90 578 pages
All Rights Reserved

HONDA MOTOR CO., LTD.
Service Publication Office

General Info



Special Tools



Specifications

specs

Maintenance



Engine



Fuel and Emissions



Transaxle



Steering



Suspension

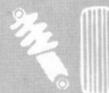

Brakes



Body



Heater and Air Conditioner

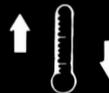

Electrical



Outline of Model Changes

ITEM	MODELS		DESCRIPTION	REFERENCE SECTION
	89	90		
Engine	○		Modified <ul style="list-style-type: none"> • Air intake hose • Mounting bolts • Bearing cap • Engine oil filter • Crankshaft pulley 	—
		○	Changed <ul style="list-style-type: none"> • Air intake hose • Exhaust manifold • Exhaust pipe A • Engine oil filter • Torque value of valve adjusting lock-nuts • Torque value of mounting bolts for front beam, rear beam and center beam 	5
PGM-FI	○		Fuel supply system modified	—
		○	ECU changed	6
Carburetor	○		Emission control system modified	—
		○	Modified <ul style="list-style-type: none"> • Vacuum hose manifold • PGM-CARB. control unit • Carburetor Adopted <ul style="list-style-type: none"> • Power valve control solenoid valve 	6
Clutch		○	Changed	7
Manual Transmission		○	Changed	8
Automatic Transmission	○		Changed <ul style="list-style-type: none"> • Inside parts • S4 switch location 	—
		○	Changed <ul style="list-style-type: none"> • Lock-up control solenoid valve • Shift control solenoid valve • On-road test valve • Line pressure and throttle B pressure of carbureted engine 	9
Differential		○	Changed	8, 9
Power Steering		○	Changed <ul style="list-style-type: none"> • Boots of front steering gearbox • Boots of rear steering gearbox (4WS) • Torque value of rear steering joint (4WS) 	11
ALB Master Cylinder	○		Changed	—
Dashboard	○		Modified	—
Heater Assembly	○		Cool air flow modified	—
Air Conditioner	○		Compressor control unit modified	—

ITEM	MODELS		DESCRIPTION	REFERENCE SECTION
	89	90		
Fuse and Power Supply Circuit	○		Changed	—
Battery	○		Changed	—
Cooling Fan Control	○		Cooling fan timer adopted	—
High Mount Brake Light	○		Adopted for KQ models	—
Stereo Sound System	○		Changed	—
Power Window	○		Changed	—
Cruise Control System	○		Clutch switch modified	—
Wiring Diagrams	○		Modified	—
Speedometer		○	Cableless speedometer adopted	16
Headlight		○	Headlight adjuster adopted for KG models	16
Foglight		○	Changed	16
High Mount Brake Light build-in Rear Spoiler		○	Adopted	16
Cigarette Lighter		○	Relay added	16
Mast Antenna		○	Retractor relay added	16



General Information

Chassis and Engine Numbers	1-2
Identification Number Locations	1-3
Label Locations	1-4
Lift and Support Points	1-6
Towing	1-9
Preparation of Work	1-10
Symbol Marks	1-17
Abbreviation	1-17

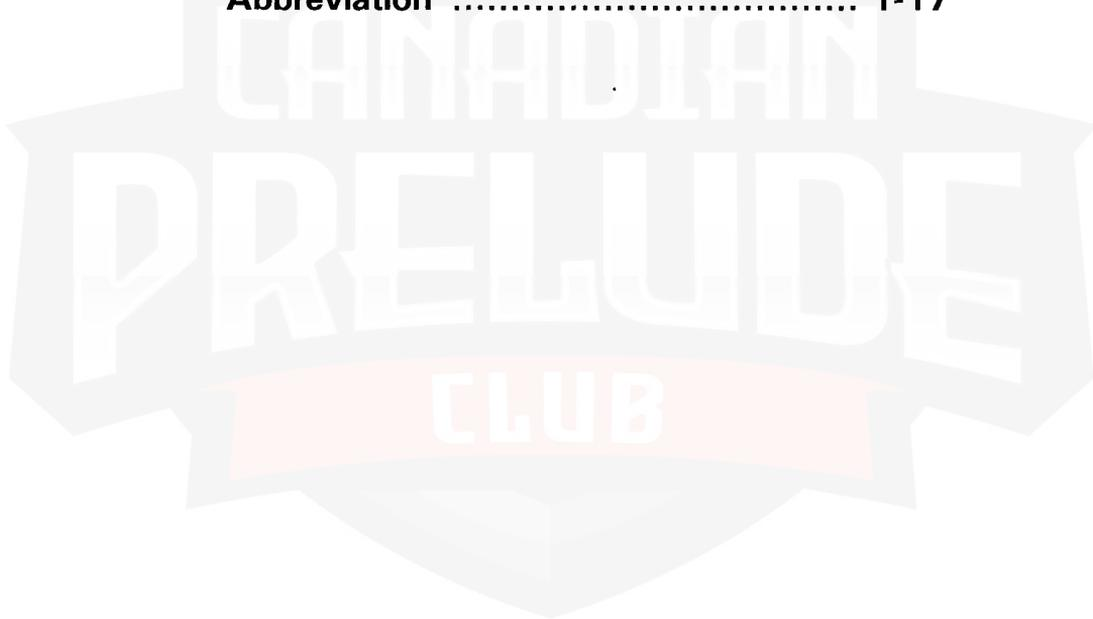

Chassis and Engine Numbers

Vehicle Identification Number (Fuel-Injected)

JHMBA41400C200001

Manufacturer Code _____
Vehicle Type _____
 M: Passenger Car
Prelude _____
Door/Transmission Type _____
 1: 2-door/5-speed manual
 2: 2-door/4-speed automatic
Vehicle grade _____
 4: 2.0 i-16 with B20A7 engine (KF, KW, KB, KE, KT)
 2.0 i-16 with B20A9 engine (KX, KS: Sweden)
 2.0 i-16 with B20A6 engine (KQ)
 2.0 Si with B20A7 engine (KY)
 8: 2.0 i-16 with B20A9 engine (KG, KW, KS: Norway/Finland)
Fixed Code _____
Auxiliary Number _____
Factory Code _____
 C: Saitama Factory Sayama Plant
Model Year _____
 2: 1990
Serial Number _____

Engine Serial Number (without KQ)

B20A3-3700001

Engine Type _____
 B20A3: 2.0 l SOHC Carbureted engine with catalytic converter for KG, KX, KS, KW models
 B20A4: 2.0 l SOHC Carbureted engine without catalytic converter for European and General models
 B20A7: 2.0 l DOHC Fuel-Injected engine without catalytic converter for European and General models
 B20A9: 2.0 l DOHC Fuel-Injected engine with catalytic converter for KG, KX, KS, KW models
Serial Number _____
 5-speed manual without catalytic converter: 3000001~
 4-speed automatic without catalytic converter: 3500001~
 5-speed manual with catalytic converter: 3700001~
 4-speed automatic with catalytic converter: 3900001~

Vehicle Identification Number (Carbureted)

JHMBA41300C200001

Manufacturer Code _____
Vehicle Type _____
 M: Passenger Car
Prelude _____
Door/Transmission Type _____
 1: 2-door/5-speed manual
 2: 2-door/4-speed automatic
Vehicle grade _____
 3: EX with B20A3 engine (KX, KS: Sweden)
 EX with B20A4 engine (KF, KW, KB, KE, KT, KY)
 7: EX with B20A3 engine (KG, KW, KS: Norway/Finland)
Fixed Code _____
Auxiliary Number _____
Factory Code _____
 C: Saitama Factory Sayama Plant
Model Year _____
 2: 1990
Serial Number _____

Engine Serial Number (KQ)

B20A6-3000001

Engine Type _____
 B20A6: 2.0 l DOHC Fuel-Injected with catalytic converter
Serial Number _____

Manual Transmission Number

D2A4-3000001

Transmission Type _____
 D2A4: for Carbureted engine equipped model (KZ, KS, KX)
 D2A5: for Carbureted engine equipped model (KF, KB, KE, KW, KT, KY) for Fuel-Injected engine equipped model (KY, KT)
 D2L5: for Fuel-Injected engine equipped model (KF, KW, KB, KE)
 D2M5: for Fuel-Injected engine equipped model (KS, KX, KQ, KZ)
Serial Number _____

Automatic Transmission Number

PY8A-1000001

Transmission Type _____
Serial Number _____



Identification Number Locations

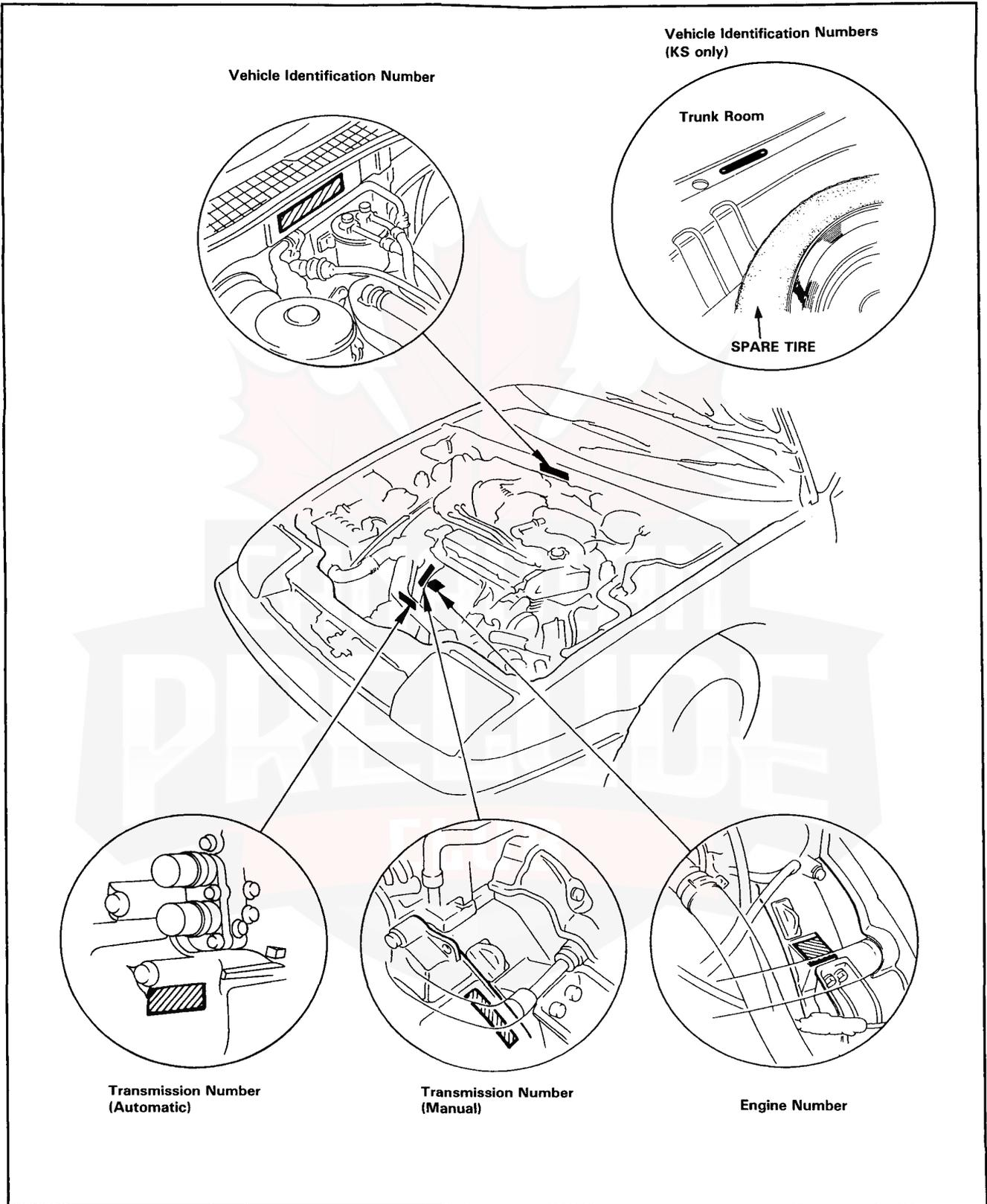

Label Locations

Fuel-Injected Engine:

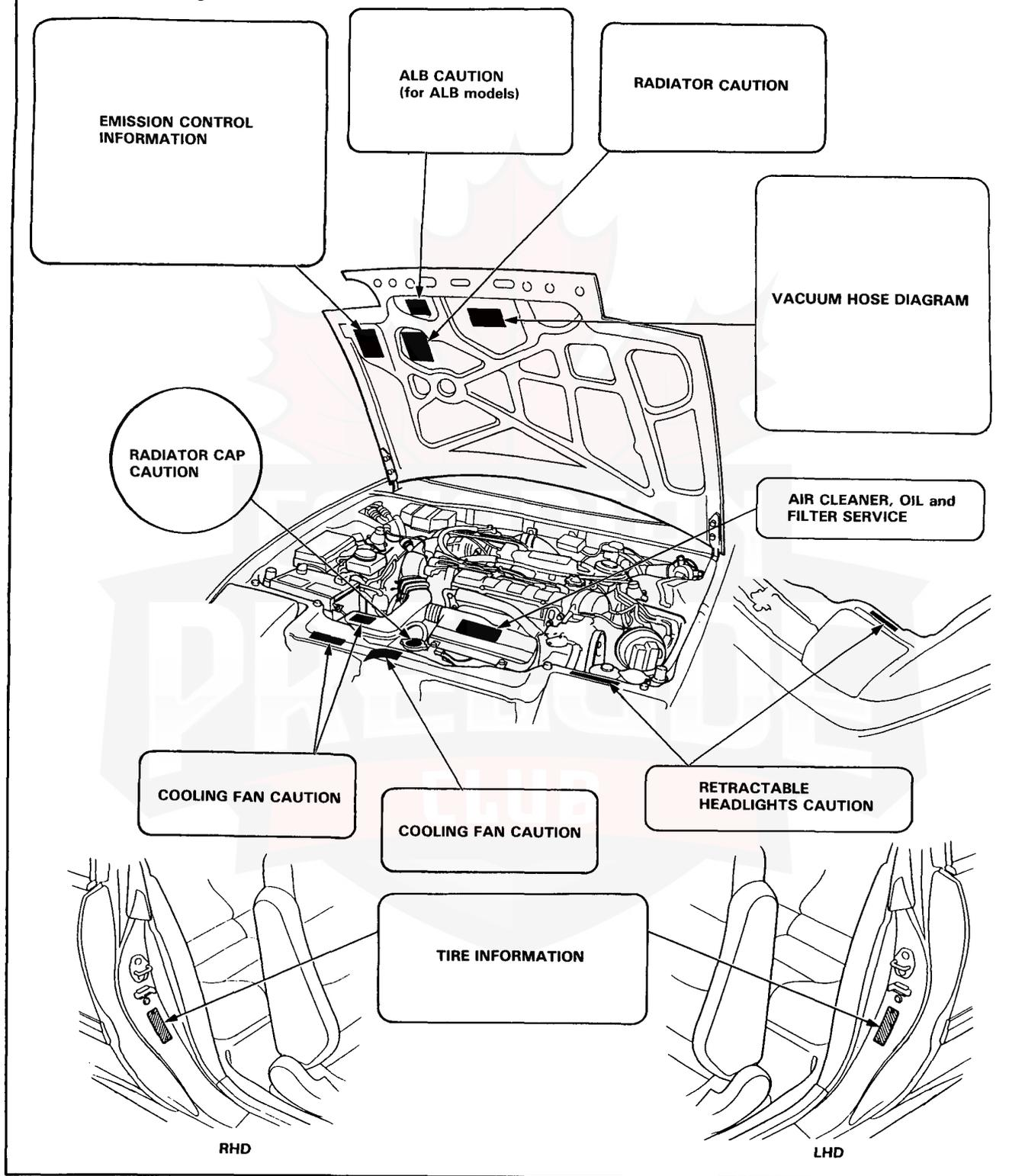



Carbureted Engine:

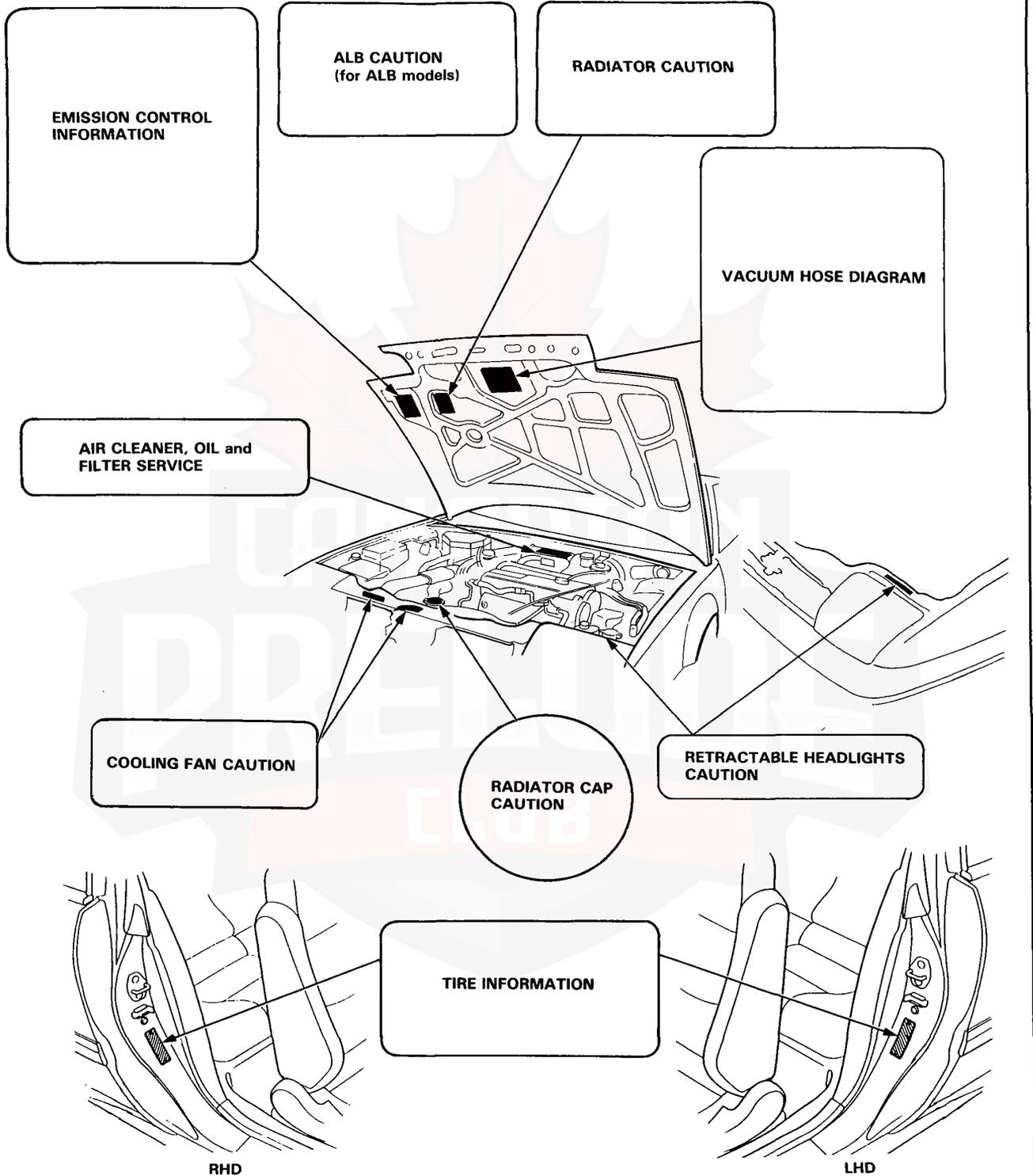

Lift and Support Points

Hoist

1. Place the lift blocks as shown.
2. Raise the hoist a few inches and rock the car to be sure it is firmly supported.
3. Raise the hoist to full height and inspect lift points for solid support.

⚠ WARNING When heavy rear components such as suspension, fuel tank, spare tire and trunk lid/hatch are to be removed, place additional weight in the trunk before hoisting. When substantial weight is removed from the rear of the car, the center of gravity may change and can cause the car to tip forward on the hoist.

NOTE: Since each tire/wheel assembly weighs approximately 14 kg (30 lbs), placing the front wheels in the trunk will assist with the weight transfer.

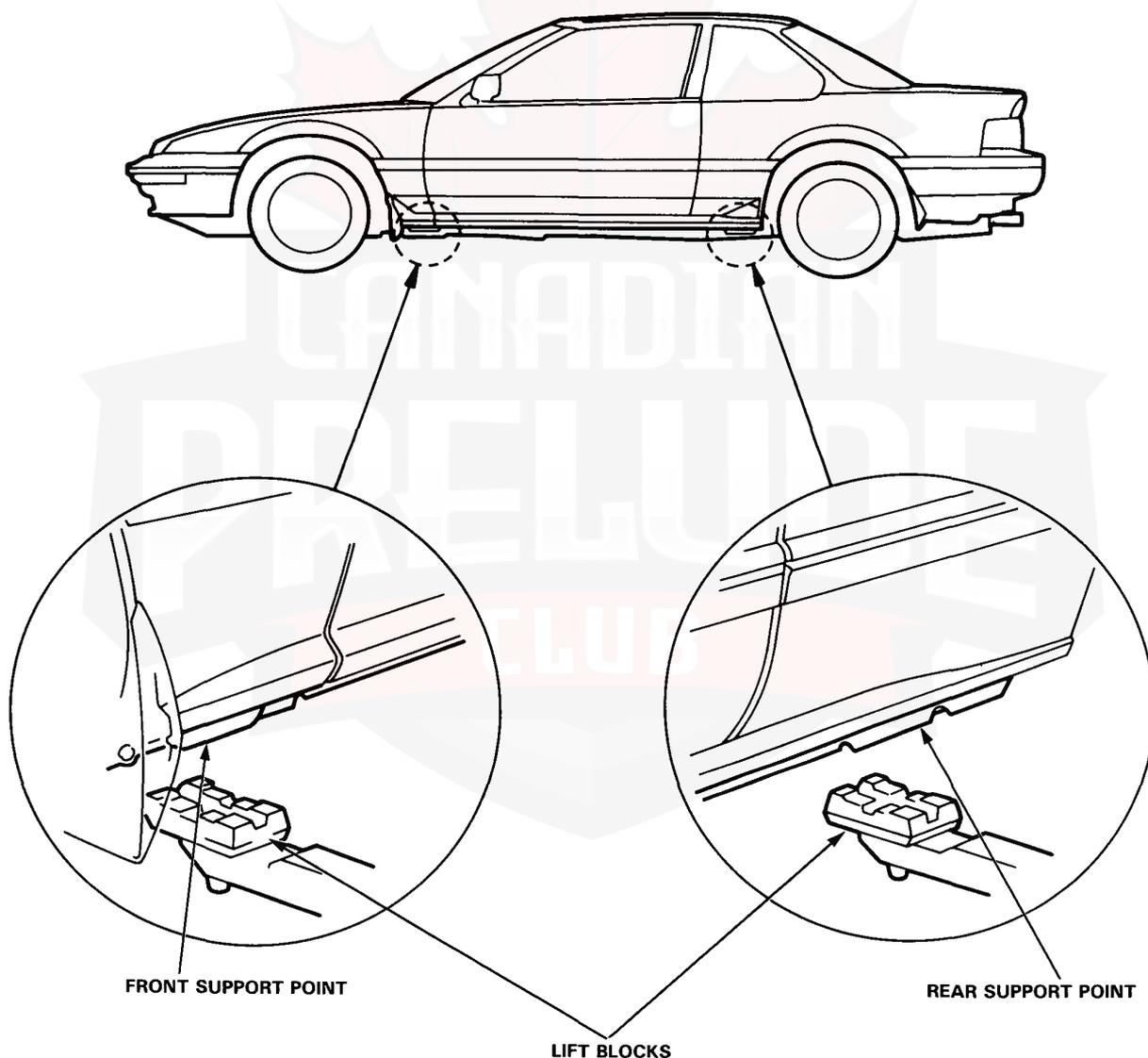



Floor Jack

1. Set the parking brake and block the wheels that are not being lifted.
2. When lifting the rear of the car, put the gearshift lever in reverse (Automatic in PARK).
3. Raise the car high enough to insert the safety stands.
4. Adjust and place the safety stands as shown on page 1-8 so the car will be approximately level, then lower the car onto the stands.

⚠ WARNING

- Always use safety stands when working on or under any vehicle that is supported by only a jack.
- Never attempt to use a bumper jack for lifting or supporting the car.

Front

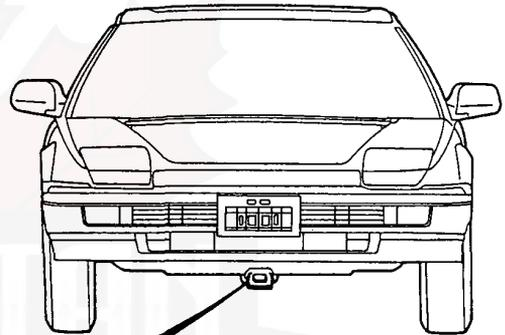
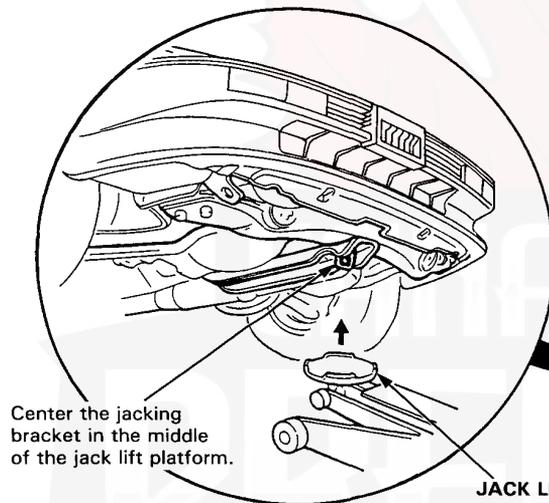

Rear

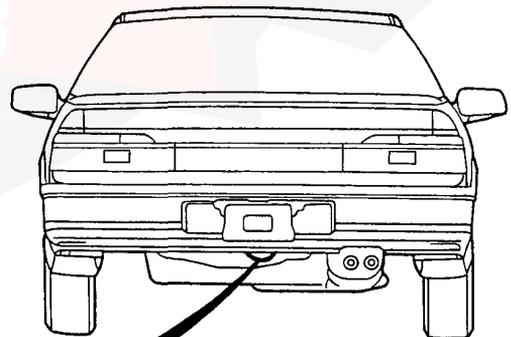
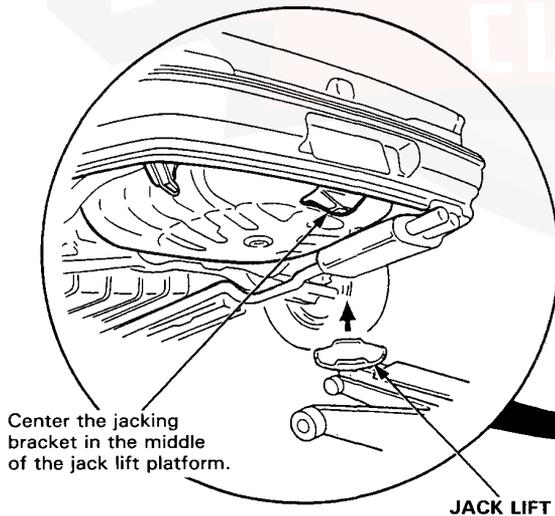

(cont'd)

Lift and Support Points (cont'd)

Safety Stands

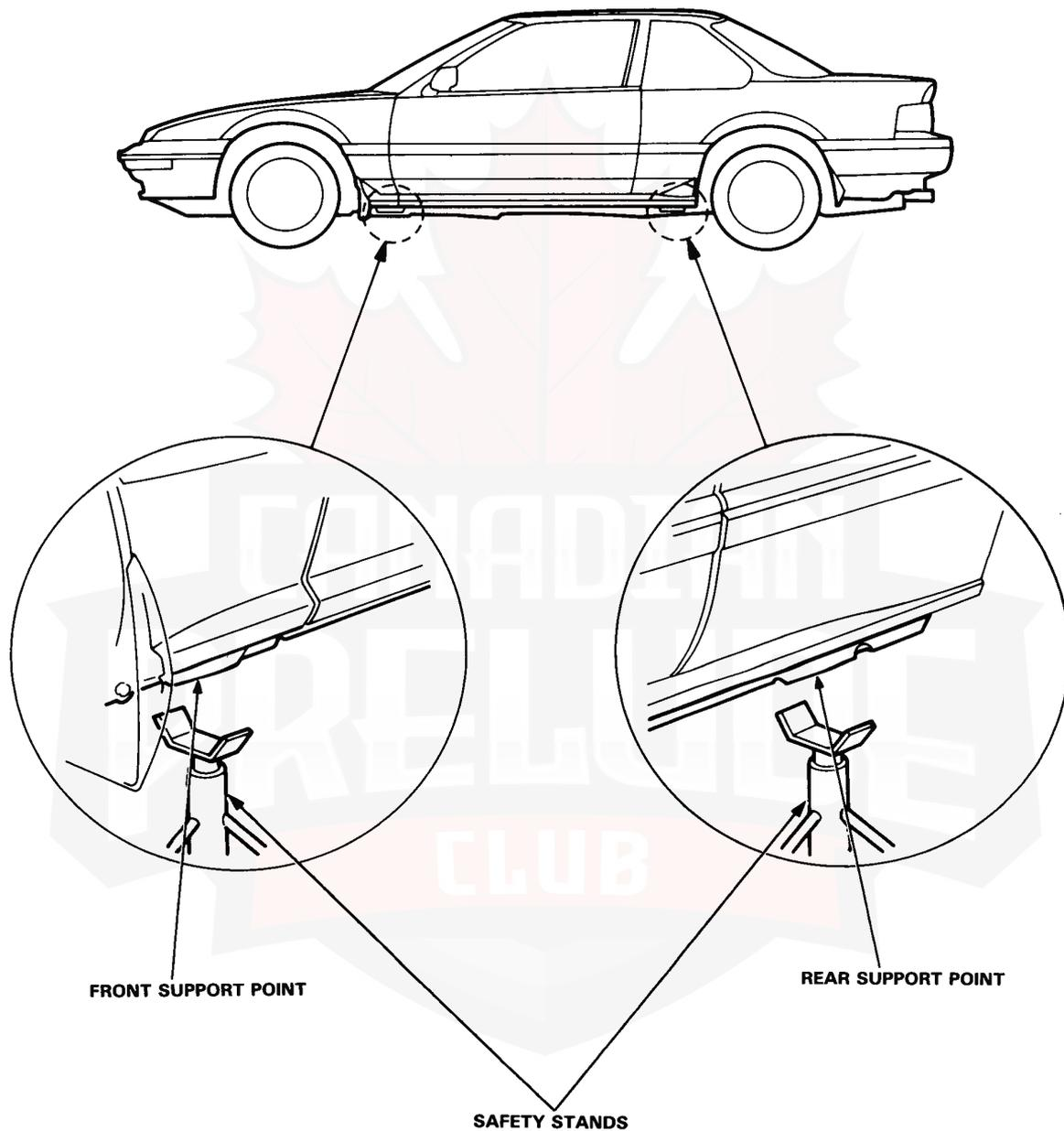

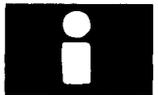

If possible, always tow the car with the front wheels off the ground. The tow truck driver should position wood spacer blocks between the car's frame and the chains and lift straps, to avoid damaging the bumper and the body under it.

Do not use the bumpers to lift the car or to support the car's weight while towing. Check local regulations for towing. A chain may be attached to the hook shown in the picture. Do not attach a tow bar to either bumper.

⚠ WARNING

DO NOT push or tow a car to start it. The forward surge when the engine starts could cause a collision. On some types, also, under some conditions, the catalytic converter could be damaged. A car equipped with an automatic transmission cannot be started by pushing or towing.

If the car is to be towed with the front wheels on the ground observe the following precautions:

Manual Transmission

Shift the transmission to Neutral and turn the ignition key to the "I" position.

Automatic Transmission

First, check the automatic transmission fluid level. Start the engine and shift to D, then to N. Return the ignition key to the "I" position.

CAUTION:

- Do not tow with front wheels on the ground when the automatic transmission fluid level is low or the transmission cannot be shifted with the engine running.
- Do not exceed 55 km/h (35 mph) or tow for distances of more than 80 km (50 miles).
- When towing a car with 4WS even with the front wheels off the ground, turn the wheels straight ahead and tie the steering wheel in place.

**TOWING HOOKS/
TIE DOWN BRACKETS**

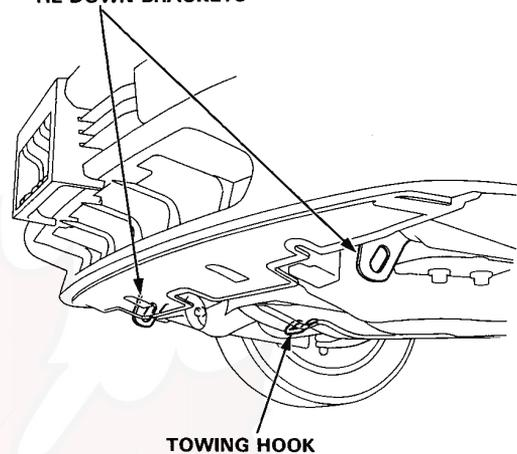

Preparation of Work

Special Caution Items For This Car

- 4WS system servicing (with 4WS)
 - Do not disassemble the rear steering gearbox.
 - When towing the car even with the front wheels off the ground, center the steering and tie the steering wheel in place.
 - When testing or adjusting the wheel alignment, attach the rear steering center lock pin to the rear steering gearbox. Make sure that the rear steering gearbox is located at the neutral position.

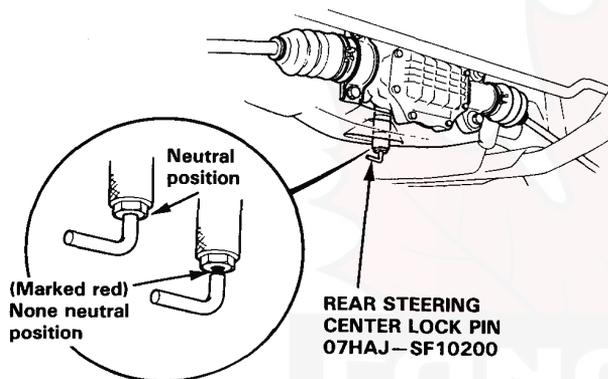

- Retractable headlights are installed. Before manual raising and lowering, the fuse must be removed. When raising and lowering is executed without removing the fuse, injury may be caused by rapid turning of the manual retracting knob, if the motors accidentally start running.

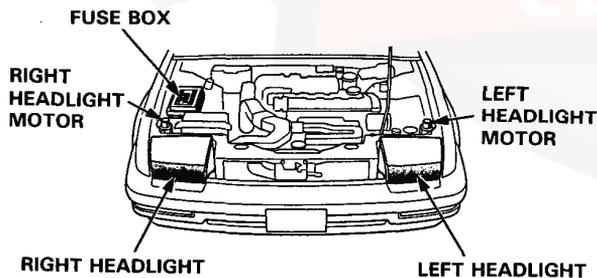

- ALB piping system servicing
 - Disassemble the ALB piping system after relieve the high-pressured brake fluid.
 - Otherwise, the high-pressured brake fluid will burst out and it is very dangerous.
 - See section 13 of Base Manual (62SF100) how to relieve the high-pressured brake fluid.

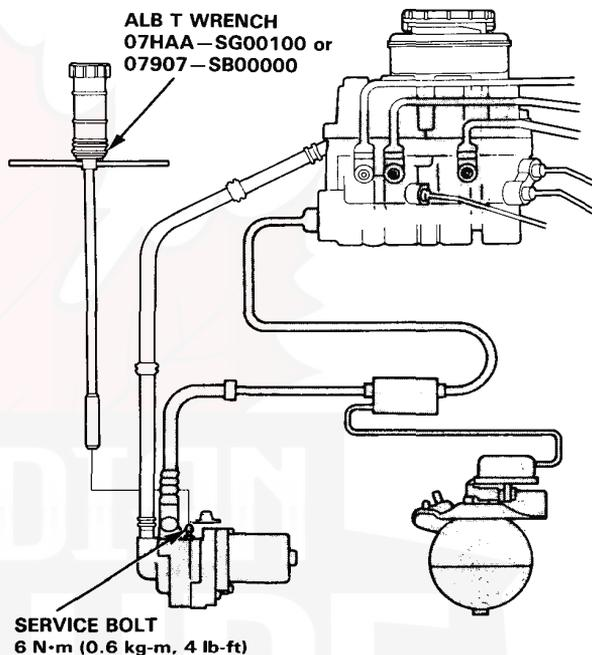

- Fuel Line Servicing
 - Relieve fuel pressure by loosening the service bolt provided on the top of the fuel filter before disconnecting a fuel hose or a fuel pipe.

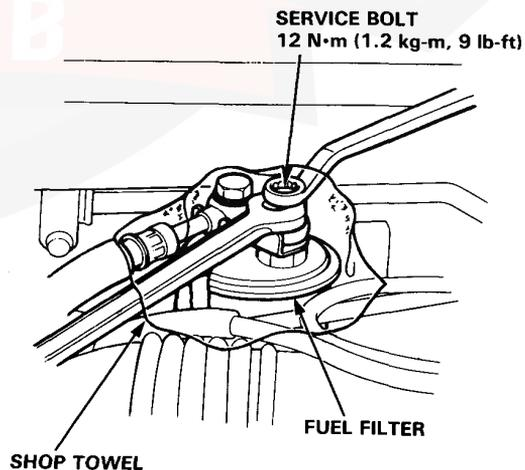



- Be sure to replace washers, O-rings, and rubber seals with new ones when servicing fuel line parts.
- Always apply oil to the surfaces of O-rings and seal rings before installation. Never use brake fluid, radiator fluid, vegetable oils or alcohol-based oils.



- When assembling the flare joint of the high-pressure fuel line, clean the joint and coat with new engine oil.
- When installing an injector, check the angle of the connector. The center line of the connector should align with the setting mark on the injector holder.

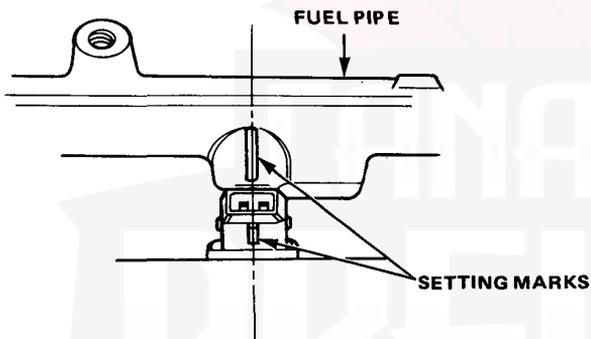

5. Inspection for fuel leakage

- After assembling fuel line parts, turn ON the ignition switch (do not operate the starter) so that the fuel pump is operated for approximately two seconds and the fuel is pressurized. Repeat this operation two or three times and check whether any fuel leakage has occurred in any of the various points in the fuel line.

6. Installation of an amateur radio

Care has been taken for the control units of the PGM-FI, PGM-CARB., A/T, Cruise control and ALB and its wiring to prevent erroneous operation from external interference, but erroneous operation of the control units may be caused by extremely strong radio waves. Attention must be paid to the following items to prevent erroneous operation of the control units.

- The antenna and the body of the radio must be at least 200 mm (7.9 in.) away from the control unit.

The control unit locations:

- PGM-FI, PGM-CARB, A/T: Passenger's side front flower panel.
- Cruise control: On the relay bracket, driver's side panel.
- ALB: Under dash center.
- Do not lead the antenna feeder and the coaxial cable over a long distance parallel to the car's wiring. When crossing the wiring is required, execute crossing at a right angle.
- Do not install a radio with a large output (max. 10 W).

7. Apply liquid gasket to the transmission, oil pump cover, right side cover and water outlet. Use Honda genuine liquid gasket, PART No. 0Y740-99986.

- Check that the mating surfaces are clean and dry before applying liquid gasket. Degrease the mating surfaces if necessary.
- Apply liquid gasket evenly, being careful to cover all the mating surface.
- To prevent leakage of oil, apply liquid gasket to the inner threads of the bolt holes.
- Do not install the parts if 20 minutes or more have elapsed since applying liquid gasket. Instead reapply liquid gasket after removing old one.
- Wait at least 30 minutes before filling with the appropriate liquid (engine oil, coolant and other similar fluids).

Preparation of Work

CAUTION: Observe all safety precautions and notes while working.

1. Protect all painted surfaces and seats against dirt and scratches with a clean cloth or vinyl cover.

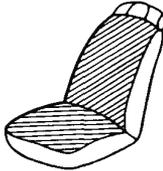

2. Work safely and give your work your undivided attention. When either the front or rear wheels are to be raised, block the remaining wheels securely. Communicate at frequently as possible when work involves two or more workers. Do not run the engine unless the shop or working area is well ventilated.

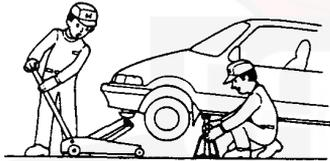

3. Prior to removing or disassembling parts, they must be inspected carefully to isolate the cause for which service is necessary. Observe all safety notes and precautions and follow the proper procedures as described in this manual.



4. Mark or place all removed parts in order in a parts rack so they can be reassembled in their original places.



5. Use the special tool when use of such a tool is specified.

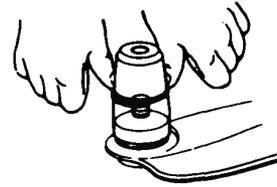

6. Parts must be assembled with the proper torque according to the maintenance standards established.
7. When tightening a series of bolts or nuts, begin with the center or large diameter bolts and tighten them in crisscross pattern in two or more steps.

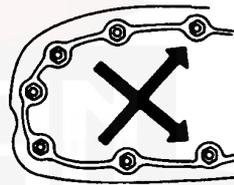

8. Use new packings, gaskets, O-rings and cotter pins whenever reassembling.

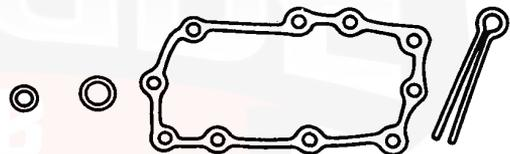

9. Use genuine HONDA parts and lubricants or those equivalent. When parts are to be reused, they must be inspected carefully to make sure they are not damaged or deteriorated and are in good usable condition.

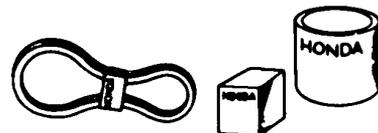



10. Coat or fill parts with specified grease as specified (page 4-2). Clean all removed parts with solvent upon disassembly.

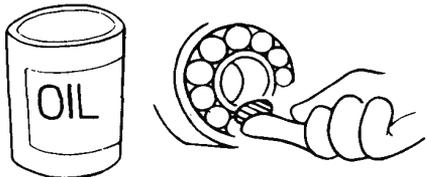

11. Brake fluid and hydraulic components

- When replenishing the system, use extreme care to prevent dust and dirt from entering the system.
- Do not mix different brands of fluid as they may not be compatible.
- Do not reuse drained brake fluid.
- Because brake fluid can cause damage to painted and resin surfaces, care should be taken not to spill it on such materials. If spilled accidentally, quickly rinse it with water or warm water from painted or resin surfaces.
- After disconnecting brake hoses or pipes, be sure to plug the openings to prevent loss of brake fluid.
- Clean all disassembled parts only in clean BRAKE FLUID. Blow open all holes and passages with compressed air.



- Keep disassembled parts from air-borne dust and abrasives.
- Check that parts are clean before assembly.

12. Avoid oil or grease getting on rubber parts and tubes, unless specified.

13. Upon assembling, check every part for proper installation and operation.

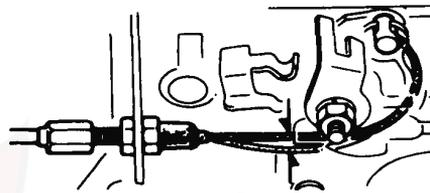

Preparation of Work

Electrical

- Before making any repairs on electric wires or parts, disconnect the battery cables from the battery starting with the negative (-) terminal.

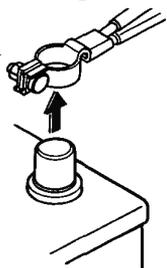

- After making repairs, check each wire or part for proper routing and installation. Also check to see that they are connected properly.
- Always connect the battery positive (+) cable first, then connect the negative (-) cable.

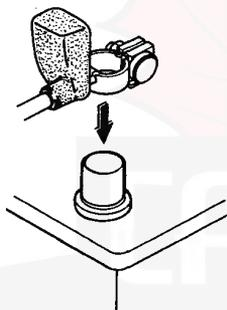

- Coat the terminals with clean grease after connecting the battery cables.
- Don't forget to install the terminal cover over the positive battery terminal after connecting.
- Before installing a new fuse, isolate the cause and take corrective measures, particularly when frequent fuse failure occurs.

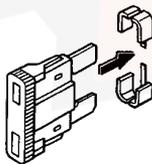

- Be sure to install the terminal cover over the connections after a wire or wire harness has been connected.

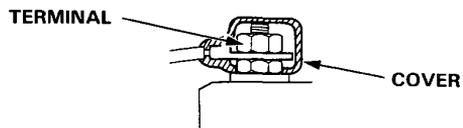

- As to locking connectors, be sure to disengage the lock before disconnecting.
- Conventional connectors may be of two types, those in which the lock is pressed to remove, and those in which the lock is pulled up to remove. Be sure to ascertain the type of locking device before beginning work. The following is a depiction of the means of disconnecting various typical connectors.

Press to disengage:

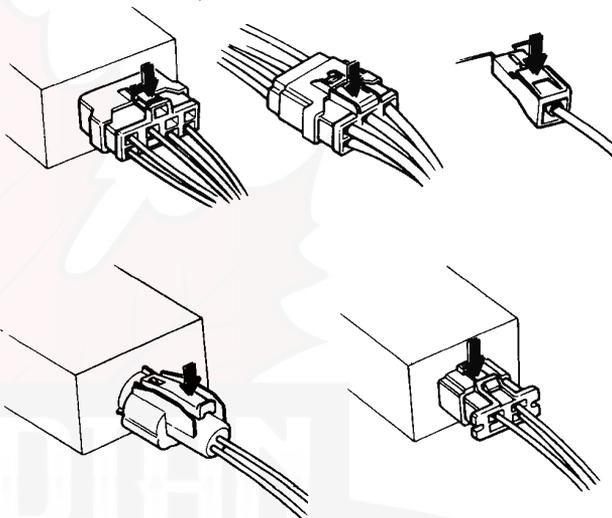

Pull up to disengage:

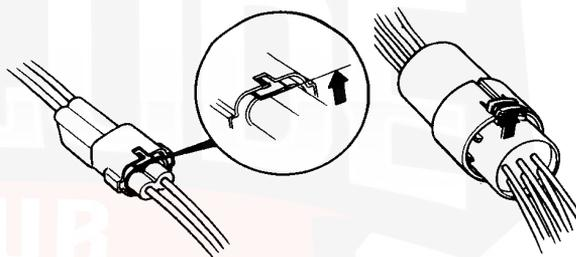



When new type connectors are used, connection and disconnection of them should be done paying attention to the following precautions.

- Because all the connectors except terminal of 1-P are equipped with push-down type locks, unlock them first before disconnecting the connectors.
- On the connectors installed on the bracket a pull type lock is equipped between the bracket and the connector.
Some connectors of this type can not be disconnected unless they are removed from their brackets. When disconnecting, check their shapes.
- On the bracket mounted connector with dual locks, remove the connector from the bracket before disconnecting.

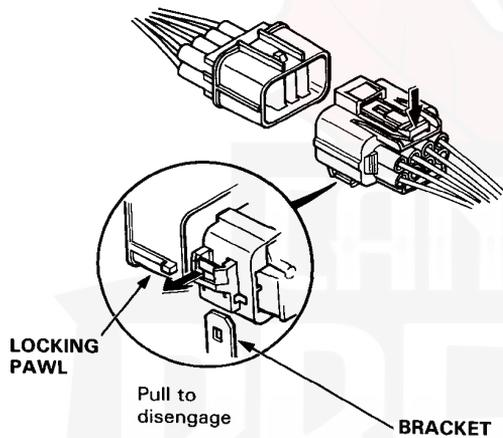

- Push the locking tab to disconnect.

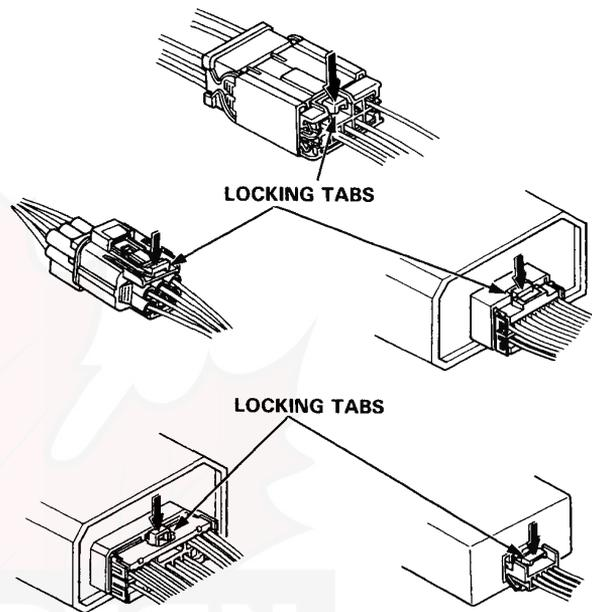

(cont'd)

Preparation of Work

Electrical

- Pull the locking tab to remove the connector from the bracket.

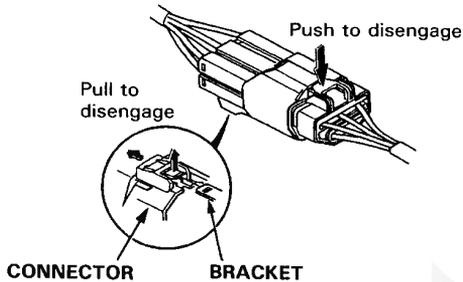

- When disconnecting locks, first press in the connector tightly (to provide clearance to the locking device), then operate the tab fully and remove the connector in the designated manner.

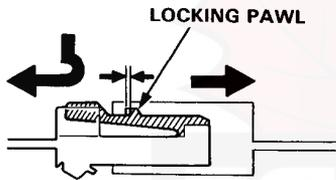

- When disconnecting a connector, pull it off from the mating connector by holding on both connectors.
- Never try to disconnect connectors by pulling on their wires.

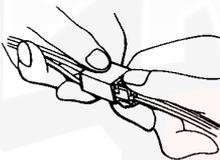

NO GOOD

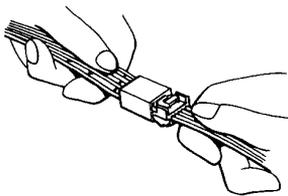

NO GOOD



- Place the plastic cover over the mating connector after reconnecting. Also check that the cover is not distorted.

NO GOOD



- Before connecting connectors, check to see that the terminals are in place and not bent or distorted.

NO GOOD

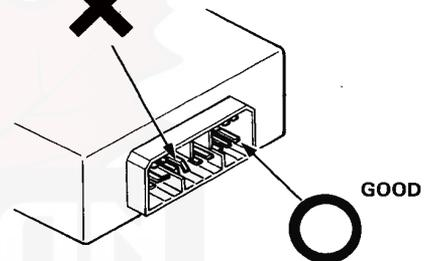

- Check for loose retainers and rubber seals. The illustration shows examples of terminal and seal abnormality.

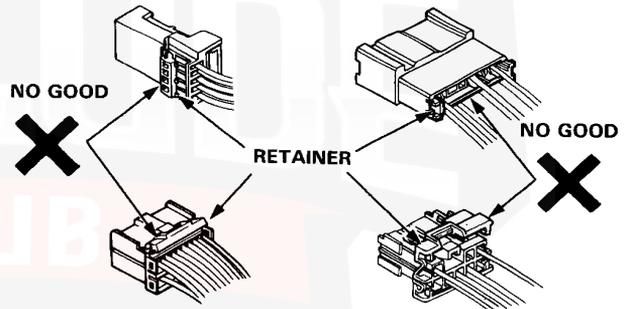

- Example of waterproof connector:



NO GOOD

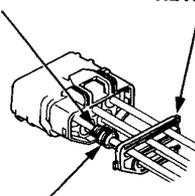

RUBBER SEAL

RETAINER

RUBBER SEAL

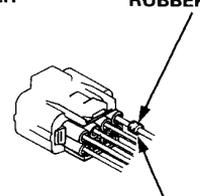

NO GOOD





- For the connector which uses insulation grease, clean the connector then apply grease if the grease is insufficient or contaminated.

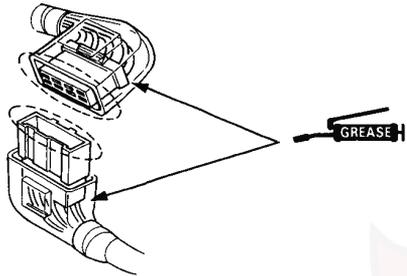

- Insert the connector tightly and make sure it is securely locked.
- Check all the wire harnesses are connected.
- There are two types of locking tab: one that you have to push and the other you should not touch when connecting the connector. Check the shape of the locking tab before connecting.
- The locking tab having a taper end should not be touched when connecting.



- The locking tab with an angle end should be pushed when connecting.



- Insert connectors fully until they will no longer go.
- The connectors must be aligned and engaged securely.
- Do not use wire harnesses with a loose wire or connector.

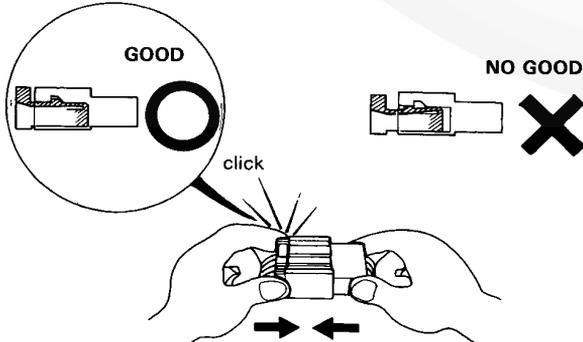

- Before connecting, check each connector cover for damage. Also make sure that the female connector is tight and not loosened from the previous use.

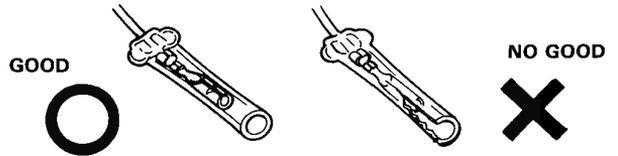

- Insert male connectors into the female connectors fully until they will no longer go.
- Be sure that plastic cover is placed over the connection.
- Position the wires so that the open end of the cover faces down.

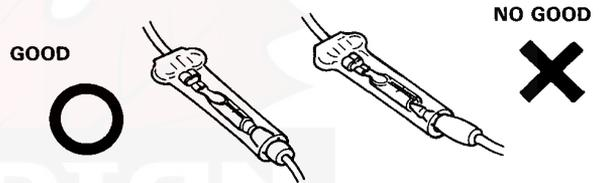

- Secure wires and wire harness to the frame with their respective wire bands at the designated locations. Position the wiring in the bands so that only the insulated surfaces contact the wires or harnesses.
- Remove with care not to damage the lock.

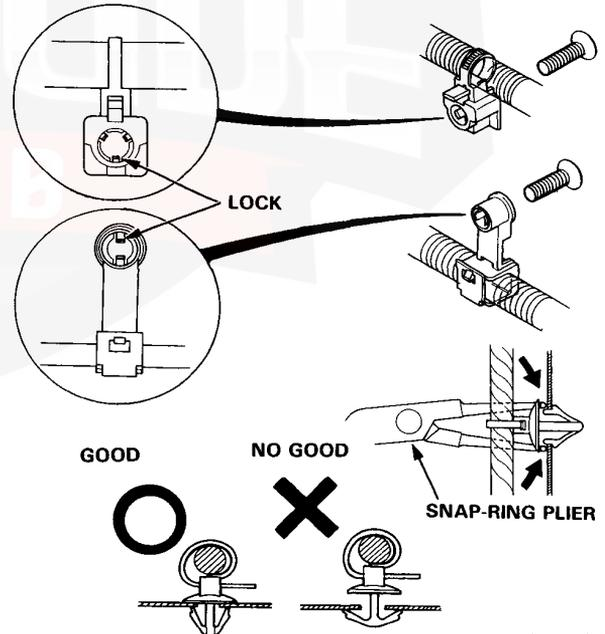

(cont'd)

Preparation of Work

Electrical

GOOD

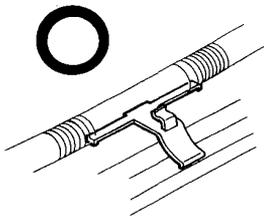

NO GOOD

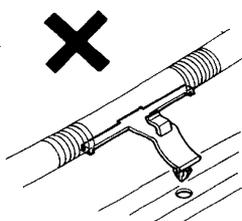

GOOD

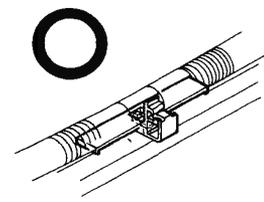

NO GOOD

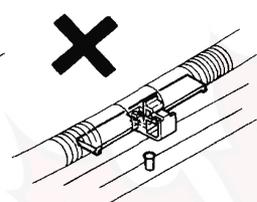

- After clamping, check each harness to be certain that it is not interfering with any moving or sliding parts of the vehicle.
- Keep wire harnesses away from the exhaust pipes and other hot parts.

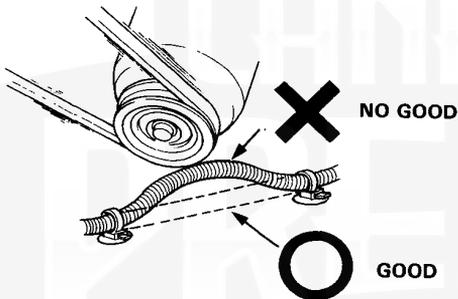

- Always keep a safe distance between wire harnesses and any heated parts.

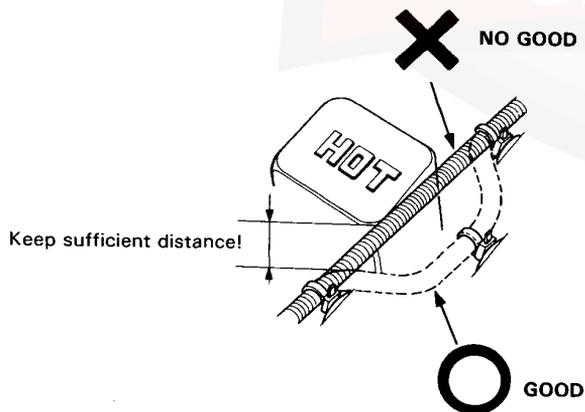

- Do not bring wire harnesses in direct contact with sharp edges or corners.
- Also avoid contact with the projected ends of bolts, screws and other fasteners.

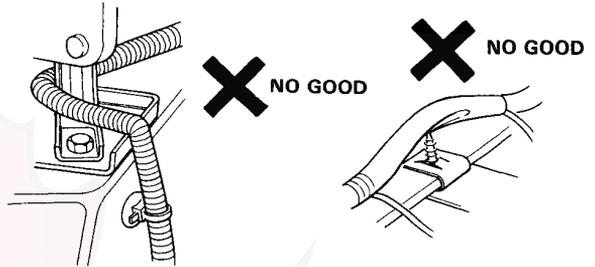

- Route harnesses so they are not pulled taut or slackened excessively.

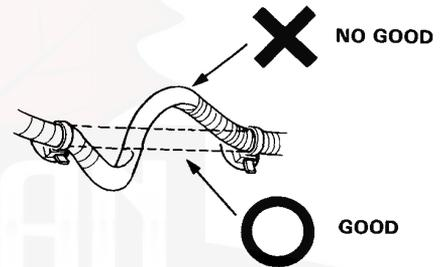

- Protect wires and harnesses with a tape or a tube if they are in contact with a sharp edge or corner.

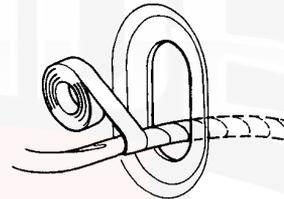

- Clean the attaching surface thoroughly if an adhesive is used. First, wipe with solvent or alcohol if necessary.

GOOD



NO GOOD

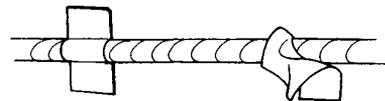



- Seat grommets in their grooves properly.

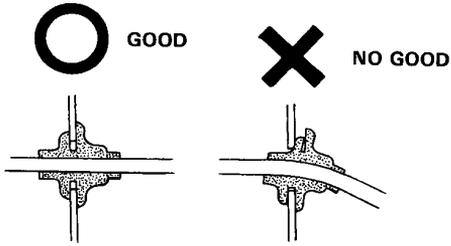

- Do not damage the insulation when connecting a wire.
- Do not use wires or harnesses with a broken insulation. Repair by wrapping with protective tape or replace with new ones if necessary.

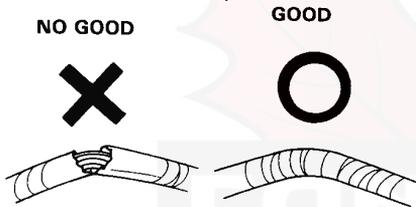

- After installing parts, make sure that wire harnesses are not pinched.

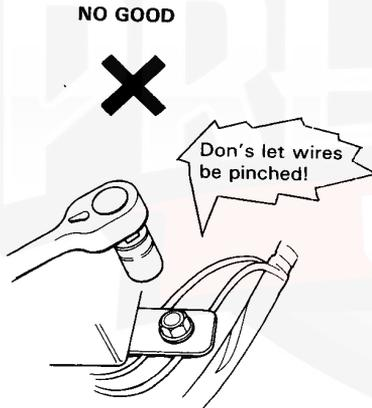

- After routing, check that the wire harnesses are not twisted or kinked.
- Wire harnesses should be routed so that they are not pulled taut, slackened excessively, pinched, or interfering with adjacent or surrounding parts in all steering positions.

- When using the Service Tester, follow the manufacturer's instructions and those described in the Shop Manual.

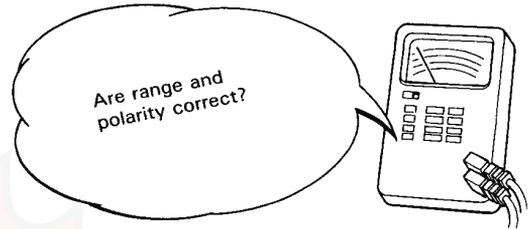

- Always insert the probe of the tester from the wire harness side (except waterproof connector).

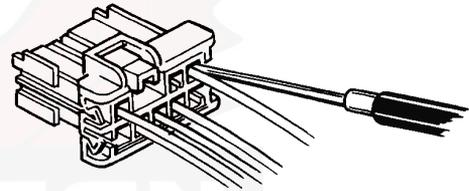

- Make sure to use the probe with a tapered tip.

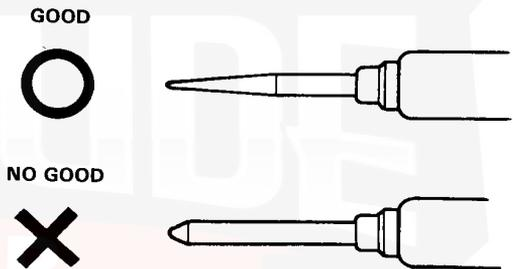

- Do not drop parts.

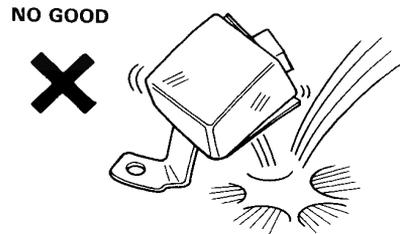

Symbol Marks

The following symbols stand for:



:Apply engine oil.



:Apply brake fluid.



:Apply grease.



: Apply DEXRON® or DEXRON® II Automatic Transmission Fluid.



: Apply Power Steering Fluid.



:Apply or check vacuum.

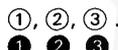

: Sequence for removal or installation

Abbreviation

2WS	Two Wheel Steering
4WS	For Wheel Steering
A/C	Air Conditioner
ALB	Anti Lock Brake
Assy	Assembly
A/T	Automatic Transmission
ATF	DEXRON® or DEXRON® II Automatic Transmission Fluid
ATT	Attachment
EACV	Electronic Air Control Valve
ECU	Electronic Control Unit for Fuel-Injection System
EGR	Exhaust Gas Recirculation
GND	Ground
IG	Ignition
INT	Intermittent
L.	Left
LHD	Left Hand Drive
M/T	Manual Transmission
PCV Valve	Positive Crankcase Ventilation Valve
PGM-FI	Programmed Fuel Injection
PGM-CARB.	Programmed Carburetor
P/S	Power Steering
R.	Right
RHD	Right Hand Drive
SW	Switch
SOL. V	Solenoid valve
TDC	Top Dead Center
P	Parking
R	Reverse
N	Neutral
D	Drive range
S	Sports range
2	Fixed at 2nd



Special Tools

New For This Model 2-2

Existing Tools

(Common with Other Models) 2-3

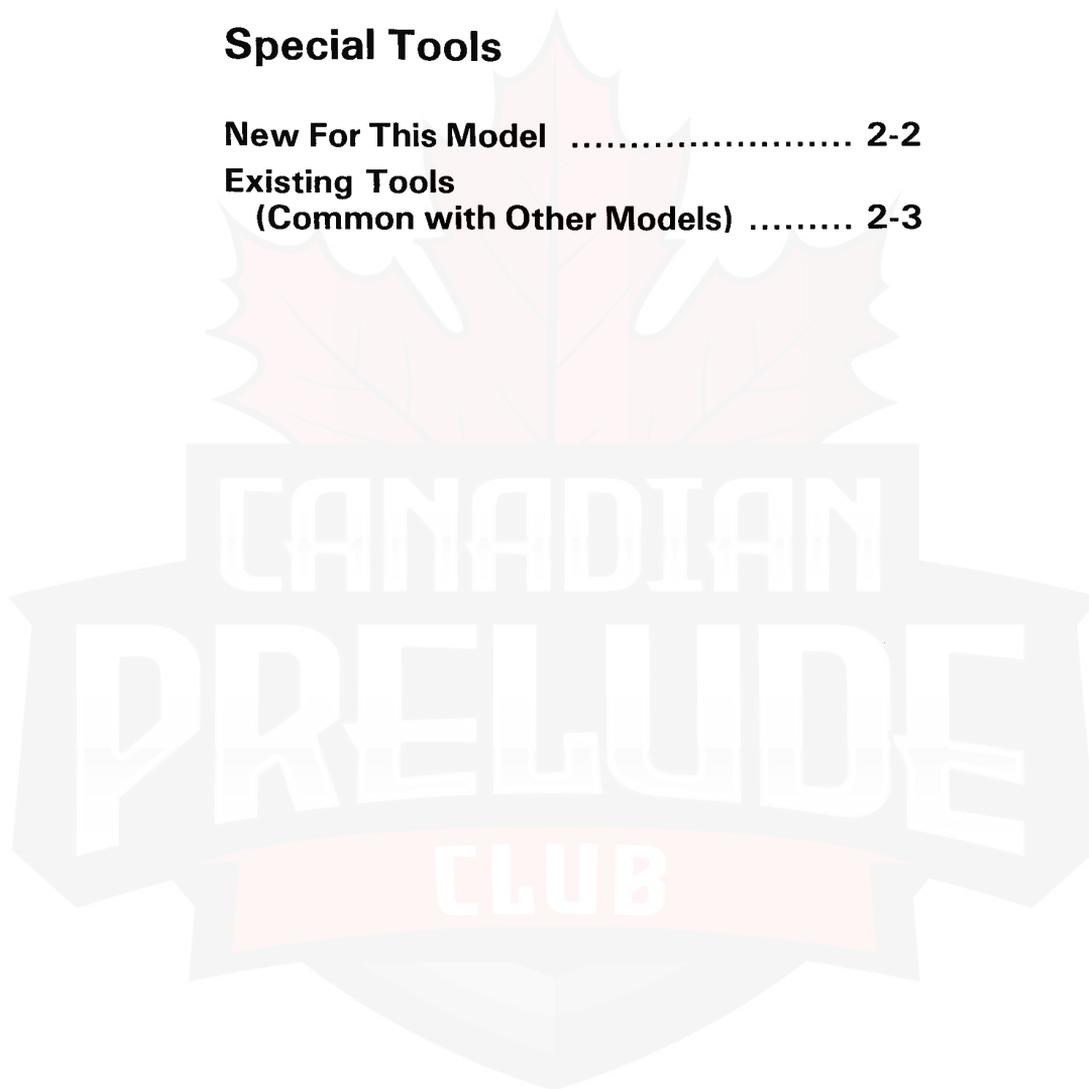

Special Tools

New Tools

Only new tools are listed below. As to other tools, refer to each section.

No.	Tool Number	Description	Q'ty	Remarks	Sec
①	07LAD—PW50600	Bearing Driver Attachment 40/50 mm	1		9



①



Existing Tools (Common with Other Models)

5. Engine

●: Carbureted Engine only ○: Fuel-Injected Engine only

Number	Tool Number	Description	Q'ty	Remarks
①	07GAD—PH70100	● Valve Seal Installer	1	
②	07GAF—PH60100	Piston Base Head	1	
③	07GAF—PH60200	● Pilot Collar	1	
④	07GAF—PH60300	Piston Pin Base Insert	1	
⑤	07GAF—PH70100	○ Pilot Collar	1	
⑥	07JAB—0010000	Crank Pulley Holder Set	1	for crankshaft pulley bolt
⑥-1	07JAA—0010200	Socket Wrench, 19 mm	(1)	} Component tools
⑥-2	07JAB—0010100	Pulley Holder Attachment	(1)	
⑥-3	07JAB—0010200	Handle	(1)	
⑦	07KAK—SJ40100	Engine Tilt Hanger Set	1	
⑧	07406—0030000	Oil Pressure Gauge Adaptor	1	
⑨	07743—0020000	Adjustable Valve Guide Driver	1	
⑩	07746—0010400	Attachment 52 x 55 mm	1	
⑪	07749—0010000	Driver	1	
⑫	07757—PJ10100	Valve Spring Compressor Attachment	1	
⑬	07757—0010000	Valve Spring Compressor	1	
⑭	07912—6110001	Oil Filter Socket	1	
⑮	07924—PD20003	Ring Gear Holder	1	
⑯	07942—SA50000	● Valve Guide Driver, 7.0 mm	1	may also be used 07942—8230000
⑰	07942—6570100	Valve Guide Driver, 6.6 mm	1	may also be used 07942—6110000
⑱	07943—6890100	Valve Guide Driver Attachment	1	
⑲	07947—SB00100	Seal Driver	1	
⑳	07948—SB00101	Driver Attachment	1	
㉑	07973—PE00302	Adj. Piston Pin Driver	1	may also be used 07973—PE00301
㉒	07973—6570002	Piston Pin Dis/Assembly Tool Set	1	
㉒-1	07973—6570500	Piston Base	(1)	} Component tools
㉒-2	07973—6570600	Piston Base Spring	(1)	
㉓	07984—SA50000	● Valve Guide Reamer, 7.0 mm	1	may also be used 07984—6890101
㉔	07984—6110000	Valve Guide Reamer, 6.6 mm	1	may also be used 07984—6570101

6. Fuel and Emissions

●: Carbureted Engine only ○: Fuel-Injected Engine only

Number	Tool Number	Description	Q'ty	Remarks
①	07GMJ—ML80100	Inspection Adaptor	1	
②	07HAZ—PJ70000	● ECU Check Adaptor A	1	
③	07HAZ—PJ7010A	● ECU Check Adaptor B	1	
④	07401—0010000	● Float Level Gauge	1	
⑤	07406—0040001	○ Fuel Pressure Gauge	1	
⑥	07411—0020000	Digital Circuit Tester	1	
⑦	07614—0050100	● Fuel Line Clamp	1	
⑧	07999—PD6000A	○ System Checker Harness	1	

Special Tools

Existing Tools (Common with Other Models)

7. Clutch

Number	Tool Number	Description	Q'ty	Remarks
①	07JAF-PM7011A	Clutch Alignment Disc	1	
②	07LAF-PT00110	Clutch Alignment Shaft	1	
③	07924-PD20003 or 07924-PD20002	Ring Gear Holder	1	
④	07936-3710100	Handle	1	

8. Manual Transmission

Number	Tool Number	Description	Q'ty	Remarks
①	07GAJ-PG20102	Mainshaft Inspection Tool	1	
①-1	07GAJ-PG20110	Shaft Holder	(1)	
①-2	07GAJ-PG20130	Base	(1)	
②*	07HAJ-PK40201	Preload Inspection Tool	1	
③	07JAC-PH80000	Adjustable Bearing Remover Set	1	
③-1	07JAC-PH80100	Bearing Remover Attachment	(1)	
③-2	07JAC-PH80200	Remover Hundle Assembly	(1)	
③-3	07741-0010201	Remover Weight	(1)	
④*	07JAD-PH80101	Seal Driver Attachment	1	
⑤*	07JAD-PH80400	Pilot Driver 28 x 30 mm	1	
⑥	07JAD-SH30100	Oil Seal Driver	1	
⑦*	07JAF-SH20200	Ball Joint Remover Base	1	
⑧	07LAD-PW50600	Bearing Driver Attachment 40/50 mm	1	New tool
⑨	07744-0010400	Pin Driver 5 mm	1	
⑩	07746-0010300	Attachment 42 x 47 mm	1	
⑪	07746-0010400	Attachment 52 x 55 mm	1	
⑫	07746-0010500	Attachment 62 x 68 mm	1	
⑬*	07746-0010600	Attachment 72 x 75 mm	1	
⑭*	07746-0041100	Pilot Driver 28 mm	1	
⑮	00749-0010000	Driver	1	
⑯*	07944-SA00000	Pin Driver 4 mm	1	
⑰*	07947-SD90100	Seal Driver Attachment	1	
⑱	07979-PJ40001	Magnet Stand Base	1	

*: For differential



9. Automatic Transmission

Number	Tool Number	Description	Q'ty	Remarks
①	07GAB—PF50100	Mainshaft Holder	1	
②	07GAC—PF40210	Bearing Remover Attachment	1	
③*	07GAD—PG20100	Pin Driver 5 mm	1	
④*	07GAD—PG40100	Oil Seal Driver	1	
⑤	07GAE—PG40001	Clutch Spring Compressor Set	1	
⑤-1	07HAE—PL50100 or 07LAE—PX40100	Clutch Spring Compressor Attachment	(1)	
⑤-2	07GAE—PG40200	Clutch Spring Compressor Bolt Assembly	(1)	
⑤-3	07960—6120101 or 07960—6120100	Clutch Spring Compressor Attachment	(1)	
⑥*	07GAJ—PG20200	Preload Inspection Tool	1	
⑦	07GMJ—ML80100	Test Harness	1	
⑧	07HAC—PK40100 or 07GAC—PG40102	Housing Puller	1	
⑨	07HAF—PK40100	Gear Installer	1	
⑩	07HAJ—PK40100	A/T Throttle Gauge	1	
⑪*	07JAD—PH80400	Pilot Driver 28 x 30 mm	1	
⑫*	07LAD—PW50600	Bearing Driver Attachment	1	
⑬	07406—0020003	A/T Oil Pressure Gauge Set	1	
⑬-1	08406—0020201	A/T Oil Pressure Gauge Replacement Hose	(1)	
⑭	07406—0070000	Low Pressure Gauge	1	
⑮	07746—0010500	Attachment 62 x 68 mm	1	
⑯*	07746—0030100	Driver C	1	
⑰*	07749—0010000	Driver A	1	
⑱	07936—6340000	Bearing Remover Set	1	
⑲*	07947—6110501	Oil Seal Driver	1	
⑳	07947—6340201	Oil Seal Driver	1	
㉑	07947—6340500	Driver Attachment E	1	
㉒	07998—SA50000	Throttle Pedal Weight Set 1.5 kg	1	
㉓	07998—SA50100	Throttle Pedal Weight Main Adopter 1.0 kg	1	
㉔	07998—SA50200	Throttle Pedal Weight Sub Adopter 0.5 kg	1	

Special Tools

Existing Tools (Common with Other Models)

10. Driveshaft

Number	Tool Number	Description	Q'ty	Remarks
①	07GAD—SE00100	Oil Seal Driver Attachment	1	
②	07746—0010400	Attachment, 52 x 55 mm	1	
③	07746—0010500	Attachment, 62 x 68 mm	1	
④	07746—0040900	Pilot, 40 mm	1	
⑤	07749—0010000	Driver	1	
⑥	07947—SD90200	Oil Seal Driver	1	
⑦	07965—SD90100	Support Base	1	
⑧	07965—SD90200	Support Collar	1	

11. Power Steering (2WS/4WS Community)

Number	Tool Number	Description	Q'ty	Remarks
①	07GAG—SD40000	P/S Tool Kit	1	
①-1	07GAG—SD40100	Piston Seal Ring Guide	(1)	Component tools
①-2	07GAG—SD40200	Piston Seal Sizing Tool	(1)	
①-3	07GAG—SD40300	Cylinder End Seal Slider	(1)	
①-4	07GAG—SD40400	End Seal Guide	(1)	
①-5	07GAG—SD40600	Tool Box	(1)	
②	07GAK—SE00100	P/S Pressure Gauge Adaptor Set	1	
②-1	07GAK—SE00110	P/S Joint Adaptor (Pump)	(1)	Component tools
②-2	07GAK—SE00120	P/S Joint Adaptor (Hose)	(1)	
③	07406—0010101	Bypass Tube Joint	1	
④	07406—0010200	P/S Pressure Gauge Set	1	
④-1	07406—0010300	Pressure Control Valve	(1)	Component tools
④-2	07406—0010400	Pressure Gauge	(1)	
⑤	07725—0030000	Pulley Holder	1	
⑥	07746—0010300	Attachment, 42 x 47 mm	1	
⑦	07749—0010000	Driver	1	
⑧	07916—SA50001	40 mm Lock Nut Wrench	1	
⑨	07941—6920003	Ball Joint Remover	1	
⑩	07947—6340300	Driver Attachment	1	
⑪	07953—7190000	Collar Driver	1	
⑫	07974—SA50600	Pinion Seal Guide	1	



11. Power Steering (4WS only)

Number	Tool Number	Description	Q'ty	Remarks
①	07HAA-SF10100	Lock Nut Socket 36 x 41 mm	1	Component tools
②	07HAG-SF10000	4WS Tool Kit	1	
②-1	07HAG-SF10100	Piston Seal Ring Guide	(1)	
②-2	07HAG-SF10200	Piston Seal Ring Sizing Tool	(1)	
②-3	07HAG-SF10300	Pinion Seal Ring Guide	(1)	
②-4	07HAG-SF10400	Pinion Seal Sizing Tool	(1)	
②-5	07HAG-SF10500	Driver Seal Ring Guide	(1)	
②-6	07HAG-SF10600	Tool Box	(1)	
③	07HAJ-SF10100	Rack Adjuster Gauge Holder Set	1	
④	07HAJ-SF10201	Rear Adjuster Center Lock Pin	1	
⑤	07HAJ-SF10300	Stroke Rod Holder Set	1	
⑥	07HAJ-SF10400	Inspection Adaptor	1	
⑦	07703-0010101	Torx Driver Bit T40	1	
⑧	07746-0010700	Attachment 24 x 26 mm	1	

12. Suspension

Number	Tool Number	Description	Q'ty	Remarks
①	07GAE-SE00101	Spring Compressor	1	may also be used 07GAE-SE00100
②	07GAF-SD40700	Hub Dis/Assembly Base	2	
③	07GAF-SE00100	Hub Assembly Pin	1	
④	07GAF-SE00200	Front Assembly Driver Attachment	1	
⑤	07GAF-SE00401	Front Hub Base	1	
⑥	07GAG-SD40700	Ball Joint Boot Clip Installation Guide	1	
⑦	07GAK-0010100	Wheel Alignment Gauge Attachment	1	
⑧	07HAD-SF10100	Hub Bearing Driver	1	
⑨	07HAF-SF10100	Ball Joint Dis/Assembly Tool Kit	1	Component tools
⑨-1	07HAF-SF10110	Ball Joint Remover Base	(1)	
⑨-2	07HAF-SF10120	Ball Joint Installer Base	(1)	
⑨-3	07HAF-SF10130	Ball Joint Remover/Installer	(1)	
⑩	07HAF-SF10200	Bearing Supporting Attachment	1	
⑪	07HAJ-SF10201	Rear Steering Center Lock Pin	1	
⑫	07HGJ-0010000	Toe Inspection Gauge Set	1	
⑬	07703-0010100	Torx Driver Bit T40	1	
⑭	07746-0010400	Attachment, 52 x 55 mm	1	
⑮	07746-0010500	Attachment, 62 x 68 mm	1	
⑯	07749-0010000	Driver	1	
⑰	07941-6920003	Ball Joint Remover	1	Component tools
⑱	07965-SB00000	Ball Joint Dis/Assembly Tool Set	1	
⑱-1	07965-SB00100	Ball Joint Remover Base	(1)	
⑱-2	07965-SB00200	Ball Joint Installer Base	(1)	
⑱-3	07965-SB00300	Ball Joint Remover/Installer	(1)	
⑲	07965-SD90100	Supporting Base	1	
⑳	07965-6920201	Front Hub Dis/Assembly Tool, B	1	
㉑	07974-SA50700	Ball Joint Boot Clip Installation Guide	1	
㉒	07974-SA50800	Ball Joint Boot Clip Installation Guide	1	

Special Tools

Existing Tools (Common with Other Models)

13. Brakes (Conventional Brakes Community)

Number	Tool Number	Description	Q'ty	Remarks
①	07GAG—SE00100	Rod Bolt Adjustment Gauge	1	
②	07HAE—SG00100	Brake Spring Compressor	1	
③	07404—5790300	Vacuum Gauge	1	
④	07406—5790200	Pressure Gauge	2	
⑤	07410—5790100	Pressure Gauge Attachment	2	
⑥	07510—6340100	Pressure Gauge Joint Pipe	2	
⑦	07510—6340300	Vacuum Joint Tube A	1	
⑧	07749—0010000	Driver	1	
⑨	07914—SA50000	Snap Ring Pliers	1	
⑩	07921—0010001	Flare Nut Wrench	1	
⑪	07947—6890300	Driver Attachment, C	1	

13. Brakes (ALB only)

Number	Tool Number	Description	Q'ty	Remarks
①	07HAJ—SG00300	ALB Checker Adaptor	1	
②	07HAK—SG00110	Pressure Gauge Joint Pipe	1	
③	07404—5790300	Vacuum Gauge	1	
④	07406—5790200	Pressure Gauge	2	
⑤	07410—5790100	Pressure Gauge Attachment	2	
⑥	07410—5790500	Tube Joint Adaptor	1	
⑦	07508—SB00000	ALB Checker	1	
⑧	07510—6340100	Pressure Gauge Joint Pipe	1	
⑨	07510—6340300	Vacuum Joint Tube A	1	
⑩	07907—SB00000	ALB-Wrench	1	
⑪	07921—0010001	Flare Nut Wrench	1	
⑫	07965—5790300	Cup Guide	1	

14. Boby

Number	Tool Number	Description	Q'ty	Remarks
①	07GAZ—SE30100	Torsion Rod Assembly Tool	1	

15. Heater and Air Conditioner

Number	Tool Number	Description	Q'ty	Remarks
①	07HAF—SF10300	Seal Seat Remover	1	
②	07HAF—SF10400	Seal Remover/Installer	1	

16. Electrical

Number	Tool Number	Description	Q'ty	Remarks
①	07GAC—SE00200	Fuel Sender Wrench	1	

Specifications

Standards and Service Limits	3-2
Design Specifications	3-13
Body Specifications	3-18
Frame Repair Chart	3-19

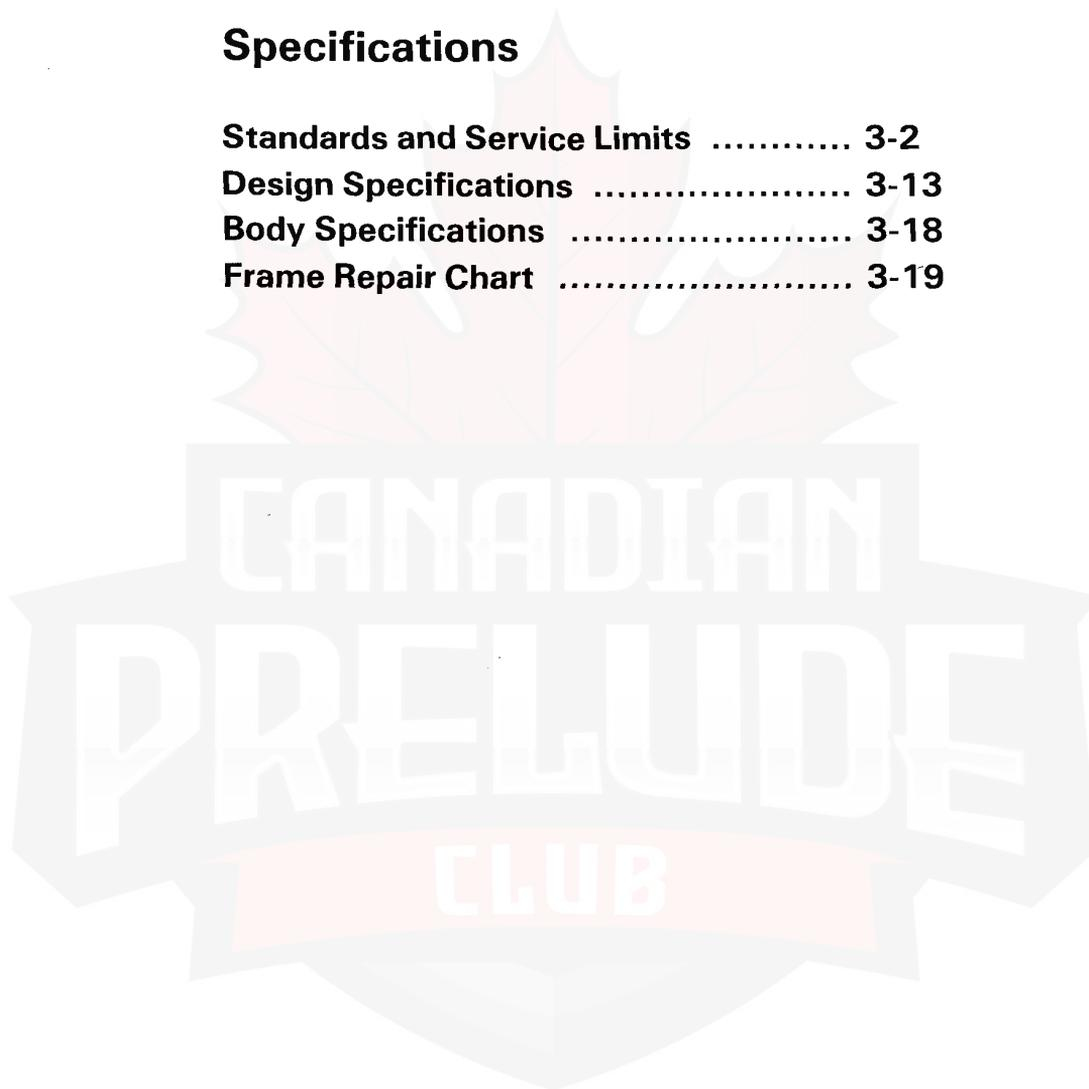

Standards and Service Limits

5. Engine/Cylinder Head, Valve Train (Fuel-Injected Engine)

		MEASUREMENT	STANDARD (NEW)	SERVICE LIMIT
Compression		250 min ⁻¹ (rpm) and wide-open throttle	Nominal Minimum Maximum variation	1,226 kPa (12.5 kg/cm ² , 178 psi) 932 kPa (9.5 kg/cm ² , 135 psi) 196 kPa (2 kg/cm ² , 28 psi)
Cylinder head		Warpage Height	— 132 (5.20)	0.05 (0.002) 131.8 (5.19)
Camshaft	End play	No. 1,2,3,4 and 6 journals No. 5 journal	0.05–0.15 (0.002–0.006) 0.050–0.089 (0.002–0.004) 0.110–0.149 (0.004–0.006)	0.5 (0.02) 0.15 (0.006) 0.21 (0.008)
	Runout Cam lobe height	IN EX	0.015 (0.0006) max. 33.716 (1.3274) 33.932 (1.3359)	0.03 (0.001) — —
Valve	Valve clearance	IN EX	0.08–0.12 (0.003–0.005) 0.16–0.20 (0.006–0.008)	— —
	Valve stem O.D.	IN EX	6.58–6.59 (0.2591–0.2594) 6.55–6.56 (0.2579–0.2583)	6.55 (0.258) 6.52 (0.257)
	Stem-to-guide clearance	IN EX	0.02–0.05 (0.001–0.002) 0.05–0.08 (0.002–0.003)	0.08 (0.003) 0.11 (0.04)
	Stem installed height	IN and EX	42.75 (1.683)	43.54 (1.714)
	Valve seat	Width	IN and EX	1.25–1.55 (0.049–0.061)
Valve spring	Free length	Inner Outer	43.50 (1.713) 47.45 (1.868)	42.5 (1.673) 46.45 (1.829)
	Squareness	Inner and Outer	—	1.6 (0.063)
Valve guide	I.D.	IN and EX	6.61–6.63 (0.260–0.261)	6.65 (0.262)

5. Engine/Cylinder Head, Valve Train (Carbureted Engine)

		MEASUREMENT	STANDARD (NEW)	SERVICE LIMIT
Compression		250 min ⁻¹ (rpm) and wide-open throttle	Nominal Minimum Maximum variation	1,177 kPa (12.0 kg/cm ² , 171 psi) 932 kPa (9.5 kg/cm ² , 135 psi) 196 kPa (2 kg/cm ² , 28 psi)
Cylinder head		Warpage Height	— 90 (3.54)	0.05 (0.002) 89.8 (3.54)
Camshaft	End play	No. 1,3 and 5 journals No. 2 and 4 journals	0.05–0.15 (0.002–0.006) 0.050–0.089 (0.002–0.004) 0.130–0.169 (0.005–0.007)	0.5 (0.02) 0.15 (0.006) 0.23 (0.009)
	Runout Cam lobe height	IN A IN B EX	0.015 (0.0006) max. 38.604 (1.5198) 38.858 (1.5298) 38.796 (1.5274)	0.03 (0.001) — — —
Valve	Valve clearance	IN EX	0.12–0.17 (0.005–0.007) 0.25–0.30 (0.010–0.012)	— —
	Valve stem O.D.	IN EX	6.58–6.59 (0.2591–0.2594) 6.94–6.95 (0.2732–0.2736)	6.55 (0.258) 6.91 (0.272)
	Stem-to-guide clearance	IN EX	0.02–0.05 (0.001–0.002) 0.06–0.09 (0.002–0.004)	0.08 (0.003) 0.12 (0.005)
	Stem installed height	IN EX	48.59 (1.913) 47.66 (1.876)	49.34 (1.943) 48.41 (1.906)
	Valve seat	Width	IN and EX	1.25–1.55 (0.049–0.061)
Valve spring	Free length	IN EX Inner Outer	48.54 (1.91) 42.42 (1.67) 49.06 (1.93)	47.54 (1.87) 41.42 (1.63) 48.06 (1.89)
	Squareness	Inner and Outer	—	1.75 (0.068)
Valve guide	I.D.	IN EX	6.61–6.63 (0.260–0.261) 7.01–7.03 (0.276–0.277)	6.65 (0.262) 7.05 (0.278)
Rocker arm	Arm-to-shaft clearance		0.008–0.054 (0.0003–0.0021)	0.08 (0.003)

5. Engine/Engine Block (Fuel-Injected Engine)

Unit: mm (in.)

MEASUREMENT		STANDARD (NEW)	SERVICE LIMIT
Cylinder block	Warpage of deck surface	0.07 (0.0028) max.	0.10 (0.004)
	Bore diameter	81.01 – 81.02 (3.1894 – 3.1898)	81.05 (3.1909)
	Bore taper	81.00 – 81.01 (3.1890 – 3.1894)	81.04 (3.1905)
	Reboring limit	—	0.05 (0.002)
Piston	Skirt O.D. (At 21 mm (0.83 in) from bottom of skirt)	80.98 – 80.99 (3.1882 – 3.1886)	80.97 (3.188)
	Clearance in cylinder	80.97 – 80.98 (3.1878 – 3.1882)	80.96 (3.187)
	Piston-to-ring clearance	0.02 – 0.04 (0.0008 – 0.0016)	0.08 (0.003)
		0.030 – 0.055 (0.0012 – 0.0022)	0.13 (0.005)
Piston ring	Ring end gap	0.20 – 0.35 (0.008 – 0.014)	0.6 (0.02)
		0.40 – 0.55 (0.016 – 0.022)	0.7 (0.03)
		0.20 – 0.70 (0.008 – 0.028)	0.8 (0.03)
Connecting rod	Pin-to-rod interference	0.013 – 0.032 (0.0005 – 0.0013)	—
	Large end bore diameter	Nominal 51 (2.01)	—
	End play installed on crankshaft	0.15 – 0.30 (0.006 – 0.012)	0.40 (0.016)
Crankshaft	Main journal diameter No. 1,2,4 and 5 journals	54.976 – 55.000 (2.1644 – 2.1654)	—
	No.3 journal	54.970 – 54.994 (2.1642 – 2.1651)	—
	Taper/out-of-round, main journal	0.005 (0.0002) max.	0.010 (0.0004)
	Rod journal diameter	47.976 – 48.000 (1.8888 – 1.8900)	—
	Taper/out-of-round, rod journal	0.005 (0.0002) max.	0.010 (0.0004)
	End play	0.10 – 0.35 (0.004 – 0.014)	0.45 (0.018)
Bearings	Runout	0.010 (0.0004) max.	0.015 (0.0006)
	Main bearing-to-journal	No.1 and 5 journals 0.018 – 0.036 (0.0007 – 0.0014)	—
	Oil clearance	No. 2 and 4 journals 0.024 – 0.042 (0.0010 – 0.0017)	0.05 (0.002)
	Rod bearing-to-journal oil clearance	No. 3 Journal 0.030 – 0.048 (0.0012 – 0.0019)	0.05 (0.002)
		0.026 – 0.044 (0.0010 – 0.0017)	0.05 (0.002)

5. Engine/Engine Block (Carbureted Engine)

MEASUREMENT		STANDARD (NEW)	SERVICE LIMIT
Cylinder block	Warpage of deck surface	0.07 (0.0028) max.	0.10 (0.004)
	Bore diameter	81.01 – 81.02 (3.1894 – 3.1898)	81.05 (3.1909)
	Bore taper	81.00 – 81.01 (3.1890 – 3.1894)	81.04 (3.1905)
	Reboring limit	—	0.05 (0.002)
Piston	Skirt O.D. (At 21 mm (0.83 in) from bottom of skirt)	80.98 – 80.99 (3.1882 – 3.1886)	80.97 (3.1878)
	Clearance in cylinder	80.97 – 80.98 (3.1878 – 3.1882)	80.96 (3.1874)
	Piston-to-ring clearance (top and 2nd)	0.02 – 0.04 (0.0008 – 0.0016)	0.08 (0.003)
		0.030 – 0.055 (0.0012 – 0.0022)	0.13 (0.005)
Piston ring	Ring end gap	0.20 – 0.35 (0.008 – 0.014)	0.6 (0.02)
		0.40 – 0.55 (0.016 – 0.022)	0.7 (0.03)
		0.20 – 0.70 (0.008 – 0.020)	0.8 (0.03)
Connecting rod	Pin-to-rod interference	0.013 – 0.032 (0.0005 – 0.0013)	—
	Large end bore diameter	Nominal 48 (1.89)	—
	End play installed on crankshaft	0.15 – 0.30 (0.006 – 0.012)	0.40 (0.016)
Crankshaft	Main journal diameter No. 1,2,4 and 5 journals	54.976 – 55.000 (2.1644 – 2.1654)	—
	No.3 journal	54.970 – 54.994 (2.1642 – 2.1651)	—
	Taper/out-of-round, main journal	0.005 (0.0002) max.	0.010 (0.0004)
	Rod journal diameter	44.976 – 45.000 (1.7707 – 1.7717)	—
	Taper/out-of-round, rod journal	0.005 (0.0002) max.	0.010 (0.0004)
	End play	0.10 – 0.35 (0.004 – 0.014)	0.45 (0.018)
Bearings	Runout	0.010 (0.0004) max.	0.015 (0.0006)
	Main bearing-to-journal	No.1 and 5 journals 0.018 – 0.036 (0.0007 – 0.0014)	—
	Oil clearance	No. 1 and 4 journals 0.024 – 0.042 (0.0010 – 0.0017)	0.05 (0.002)
	Rod bearing-to-journal oil clearance	No. 3 Journal 0.030 – 0.048 (0.0012 – 0.0019)	0.05 (0.002)
		0.026 – 0.044 (0.0010 – 0.0017)	0.05 (0.002)

(cont'd)

Standards and Service Limits (cont'd)

○ : Fuel-Injected Engine

● : Carbureted Engine

5. Engine/Engine Lubrication

	MEASUREMENT	STANDARD (NEW)	SERVICE LIMIT
Engine oil	Capacity ℓ (US. qt., Imp. qt.)	4.7 (5.0, 4.1) After engine disassembly 3.8 (4.0, 3.3) After oil change, including oil filter 3.4 (3.6, 3.0) After oil change, without oil filter	
Oil pump	Displacement	○ 54 ℓ (14.3 US. gal., 11.9 Imp. gal.) 5,000 min ⁻¹ (rpm) ● 54 ℓ (14.3 US. gal., 11.9 Imp. gal.) 5,500 min ⁻¹ (rpm)	
	Inner-to-outer rotor radial clearance	0.04–0.16 (0.002–0.006)	0.2 (0.008)
	Pump body-to-rotor radial clearance	0.10–0.19 (0.004–0.007)	0.21 (0.008)
	Pump body-to-rotor side clearance	0.02–0.07 (0.001–0.003)	0.12 (0.005)
Relief valve	Pressure setting 80°C (176°F) kPa (kg/cm ² , psi)	Idle	69 (0.7, 10) min.
		3,000 min ⁻¹ (rpm)	343 (3.5, 50)

5. Engine/Cooling

	MEASUREMENT	STANDARD (NEW)	SERVICE LIMIT
○ Radiator	Capacity (includes heater) ℓ (U.S. qt., Imp. qt.) (Includes reservoir tank 0.75 (0.79, 0.66))	7.8 (8.2, 6.9)	
● Radiator	Capacity (includes heater) ℓ (U.S. qt., Imp. qt.) (Includes reservoir tank 0.75 (0.79, 0.66))	Manual 6.8 (7.2, 6.0) Automatic 7.5 (7.9, 6.6)	
Radiator cap	Pressure cap opening pressure	74–103 kPa (0.75–1.05 kg/cm ² , 11–15 psi)	
Thermostat	Starts to open	82°C ± 2 (180°F ± 3)	86–90°C (187–194°F)
	Full open	95°C (203°F)	100°C (212°F) OPTIONAL
	Valve lift at full open	8 (0.31) max.	8 (0.31) max.
○ Water pump	Gear ratio (crankshaft)	0.89	
	Capacity: ℓ per min/at min ⁻¹ (rpm)	158 (41.7 U.S. gal., 34.8 Imp. gal.)/6,000	
● Water pump	Gear ratio (crankshaft)	1.00	
	Capacity: ℓ per min/at min ⁻¹ (rpm)	145 (38.3 U.S. gal., 31.9 Imp. gal.)/6,000	
Cooling fan	Fan-to-core clearance	26.0 (1.02)	
	Thermostat "ON" temperature	87°–93°C (188°–199°F)	
	Thermostat "OFF" temperature	83° (181°F) or more (hysteresis 2°C (35°F) or more).	

6. Fuel and Emissions

	MEASUREMENT	STANDARD (NEW)
○ Fuel pump	Delivery pressure	250 kPa (2.55 kg/cm ² , 36 psi)
	Displacement	230 cm ³ /min in 10 seconds
	Relief valve opening pressure	441–588 kPa (4.5–6.0 kg/cm ² , 64–85 psi)
● Fuel pump	Delivery pressure	8.8–14.7 kPa (0.09–0.15 kg/cm ² , 1.3–2.1 psi)
	Displacement	600 cm ³ /min at 12 V (37 cu. in./12 V)
○ Pressure regulator	Pressure	230–270 kPa (2.35–2.75 kg/cm ² , 33–39 psi)
Fuel Tank	Capacity	60 ℓ (15.9 U.S. gal., 13.2 Imp. gal.)

○ : Fuel-Injected Engine

● : Carbureted Engine

Unit: mm (in.)

6. Fuel and Emissions

	MEASUREMENT	STANDARD (NEW)	
Throttle valve body or carburetor	Fast idle min ⁻¹ (rpm)	Manual ○ 1,000–1,800 Automatic ○ 1,000–1,800	● 1,000–2,000 ● 1,000–2,000
	Idle speed min ⁻¹ (rpm) with headlights and cooling fan off	○ Manual Automatic (in gear)	750 ± 50 (with catalytic converter) 800 ± 50 (without catalytic converter)
		● Manual Automatic (in gear)	M/T: 800 ± 50 A/T: 750 ± 50
	Idle CO	0.1 %	
Float level (from gasket)	15–17 (0.59–0.67)		

7. Clutch

	MEASUREMENT	STANDARD (NEW)	SERVICE LIMIT
Clutch pedal	Pedal height	207 (8.1) to floor	—
	Stroke	135–140 (5.3–5.5)	—
	Pedal play	9–15 (0.4–0.6)	—
	Disengagement height	92 (3.6) min. to floor	—
Flywheel	Clutch surface runout	0.05 (0.002) max.	0.15 (0.006)
Clutch disc	Rivet head depth	1.3 (0.05) min.	0.2 (0.008)
	Surface runout	0.8 (0.03) max.	1.0 (0.04)
	Thickness	8.5–9.2 (0.33–0.36)	6.1 (0.24)
Clutch release bearing holder	I.D.	35.00–35.059 (1.378–1.380)	35.09 (1.381)
	Holder-to-guide sleeve clearance	0.05–0.15 (0.002–0.006)	0.22 (0.009)
Clutch cover	Unevenness of diaphragm spring	0.6 (0.02) max.	0.8 (0.03)

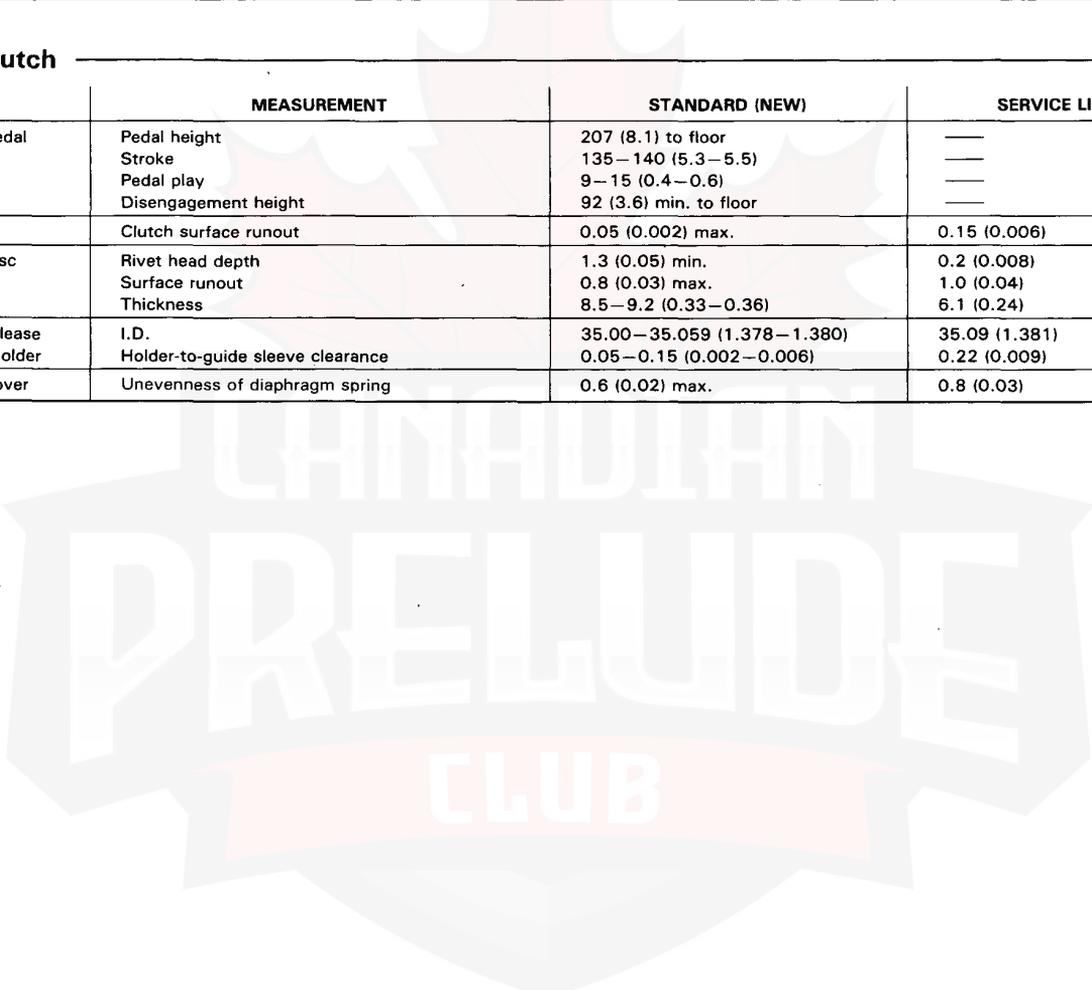

(cont'd)

Standards and Service Limite (cont'd)

Unit: mm (in)

8. Manual Transmission

	MEASUREMENT	STANDARD (NEW)	SERVICE LIMIT
Transmission oil	Capacity ℓ (US qt, Imp qt)	2.1 (2.2, 1.9) at assembly 2.2 (2.3, 1.9) at oil change	
Mainshaft	End play Diameter of ball bearing contact area Diameter of third gear contact area Diameter of ball bearing contact area Runout	0.10–0.16 (0.0039–0.0063) 27.977–27.990 (1.1015–1.1020) 37.984–38.000 (1.4954–1.4961) 27.987–28.000 (1.1018–1.1024) 0.02 (0.0008) max.	Adjust with a shim. 29.93 (1.1783) 37.930 (1.4933) 27.940 (1.1000) 0.05 (0.002)
Mainshaft third and fourth gears	I.D. End play Thickness 3rd gear 4th gear	43.009–43.025 (1.6933–1.6939) 0.06–0.21 (0.0024–0.0083) 32.42–32.47 (1.276–1.278) 30.92–30.97 (1.217–1.219)	43.080 (1.6961) 0.30 (0.012) 32.3 (1.27) 30.8 (1.21)
Mainshaft fifth gear	I.D. End play Thickness	43.009–43.025 (1.6933–1.6939) 0.06–0.21 (0.0024–0.0083) 30.42–30.47 (1.198–1.200)	43.080 (1.6961) 0.30 (0.012) 30.3 (1.193)
Countershaft	End play Diameter of needle bearing contact area Diameter of ball bearing needle bearing contact area Diameter of low gear contact area Runout	0.05–0.21 (0.0019–0.0083) 33.000–33.015 (1.2992–1.2998) 24.987–25.000 (0.9837–0.9845) 39.984–40.000 (1.5742–1.5748) 0.02 (0.0008) max.	0.50 (0.02) 32.95 (1.297) 24.94 (0.982) 39.93 (1.572) 0.05 (0.002)
Countershaft low gear	I.D. End play	46.009–46.025 (1.8114–1.8120) 0.04–0.10 (0.002–0.004)	46.08 (1.814) Adjust with a washer.
Countershaft second gear	I.D. End play Thickness	50.009–50.025 (1.9689–1.9695) 0.04–0.10 (0.002–0.004) 33.92–33.97 (1.335–1.337)	50.08 (1.972) Adjust with a collar. 32.8 (1.2913)
Spacer collar (Countershaft second gear)	I.D. O.D. Length	36.48–36.49 (1.4362–1.4366) 43.989–44.000 (1.7318–1.7323) 29.03–29.05 (1.1429–1.1437) 28.98–29.00 (1.1409–1.1417)	36.50 (1.437) 43.94 (1.730) — —
Spacer collar (Mainshaft fourth and fifth gears)	I.D. O.D. Length	31.002–31.012 (1.2205–1.2209) 37.989–38.000 (1.4956–1.4961) 56.45–56.55 (2.222–2.226) 26.03–26.08 (1.0248–1.0268)	31.06 (1.223) 37.94 (1.494) — 26.01 (1.024)
Reverse idler gear	I.D. Gear-to-reverse gear shaft clearance	20.016–20.043 (0.7880–0.7891) 0.036–0.084 (0.0014–0.0033)	20.09 (0.7909) 0.160 (0.006)
Synchronizer ring	Ring-to-gear clearance (ring pushed against gear)	0.85–1.10 (0.0335–0.0433)	0.40 (0.016)
Shift fork	Synchronizer sleeve groove width Fork-to-synchronizer sleeve clearance	6.75–6.85 (0.266–0.270) 0.35–0.65 (0.014–0.026)	— 1.0 (0.039)
Reverse shift fork	Pawl groove width Fork-to-reverse idle gear clearance Groove width Fork-to-fifth/reverse shift Shaft clearance	13.0–13.3 (0.51–0.52) 0.5–1.1 (0.02–0.43) 7.05–7.25 (0.278–0.2854) 7.4–7.7 (0.29–0.30) 0.05–0.35 (0.002–0.014) 0.4–0.8 (0.02–0.03)	— 1.8 (0.07) — — 0.5 (0.02) 1.0 (0.04)
Shift arm	I.D. Shift arm-to-shaft clearance Shift fork diameter at contact area Shift-arm-to-shift fork shaft clearance	15.973–16.000 (0.6289–0.6299) 0.005–0.059 (0.0002–0.0023) 12.9–13.0 (0.508–0.512) 0.2–0.5 (0.01–0.02)	— — — 0.6 (0.02)
Select lever	Pin size of contact area Shaft outer diameter Shift arm cover clearance	7.9–8.0 (0.311–0.315) 15.41–15.68 (0.607–0.617) 0.032–0.102 (0.0013–0.0040)	— — —
Shift arm lever	O.D. Transmission housing clearance	15.941–15.968 (0.6276–0.6287) 0.027–0.139 (0.0011–0.0055)	— —
Inter lock	Bore diameter Shift arm lever clearance	16.00–16.05 (0.630–0.632) 0.032–0.109 (0.0013–0.0043)	— —

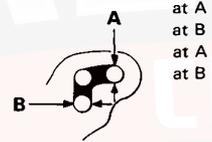
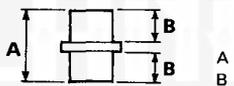

9. Automatic Transmission

	MEASUREMENT		STANDARD (NEW)	SERVICE LIMIT	
Transmission oil	Capacity ℓ (US qt, Imp qt)		2.8 (3.0, 2.5) at oil change 6.2 (6.6, 5.5) at assembly		
Hydraulic pressure	N or P	Line pressure at 2,000 rpm	○ 834–883 kPa (8.5–9.0 kg/cm ² , 121–128 psi) ● 711–809 kPa (7.25–8.25 kg/cm ² , 103–117 psi)	○ 785 kPa (8.0 kg/cm ² , 114 psi) ● 711 kPa (7.25 kg/cm ² , 103 psi)	
	S or D	4th, 3rd, 2nd clutch pressure at 2,000 rpm	○ 471–883 kPa (4.8–9.0 kg/cm ² , 68–128 psi) ● 471–834 kPa (4.8–8.5 kg/cm ² , 68–121 psi)	○ 785 kPa (8.0 kg/cm ² , 114 psi) ● 711 kPa (7.25 kg/cm ² , 103 psi)	
	S or D	1st clutch pressure at 2,000 rpm	○ 834–883 kPa (8.5–9.0 kg/cm ² , 121–128 psi) ● 711–809 kPa (7.25–8.25 kg/cm ² , 103–117 psi)	○ 785 kPa (8.0 kg/cm ² , 114 psi) ● 711 kPa (7.25 kg/cm ² , 103 psi)	
	2	2nd clutch pressure at 2,000 rpm	○ 834–883 kPa (8.5–9.0 kg/cm ² , 121–128 psi) ● 711–809 kPa (7.25–8.25 kg/cm ² , 103–117 psi)	○ 785 kPa (8.0 kg/cm ² , 114 psi) ● 711 kPa (7.25 kg/cm ² , 103 psi)	
	S or D	Throttle pressure B	Fully closed	0	—
		Fully open	○ 834–883 kPa (8.5–9.0 kg/cm ² , 121–128 psi) ● 711–809 kPa (7.25–8.25 kg/cm ² , 103–117 psi)	○ 785 kPa (8.0 kg/cm ² , 114 psi) ● 711 kPa (7.25 kg/cm ² , 103 psi)	
Stall speed	Check with car on level ground		○ 2,500–2,800 rpm ● 2,450–2,750 rpm	— —	
Clutch	Clutch initial clearance		1st 0.65–0.85 (0.026–0.033)	—	
			2nd, 3rd, 4th 0.40–0.60 (0.016–0.024)	—	
	Clutch return spring free length		31.0 (1.22)	29.0 (1.14)	
	Clutch disc thickness		1.88–2.00 (0.074–0.079)	Until grooves worn out	
	Clutch plate thickness		1.95–2.05 (0.077–0.079)	Discoloration ↑ ↓ Discoloration	
	Clutch end plate thickness		2.05–2.10 (0.081–0.083)		
	Mark 1		2.15–2.20 (0.085–0.087)		
	Mark 2		2.25–2.30 (0.089–0.091)		
	Mark 3		2.35–2.40 (0.093–0.094)		
	Mark 4		2.45–2.50 (0.096–0.098)		
	Mark 5		2.55–2.60 (0.100–0.102)		
	Mark 6		2.65–2.70 (0.104–0.106)		
	Mark 7		2.75–2.80 (0.108–0.110)		
	Mark 8		2.85–2.90 (0.112–0.114)		
Mark 9		2.95–3.00 (0.116–0.118)			
Mark 10		3.05–3.10 (0.120–0.122)			
Mark 11		3.15–3.20 (0.124–0.126)			
Mark 12		3.25–3.30 (0.128–0.130)			
Mark 13		3.35–3.40 (0.132–0.134)			
Mark 14					

○ : Fuel-Injected Engine

● : Carbureted Engine

(cont'd)

Standard and Service Limits (cont'd)

9. Automatic Transmission (cont'd)

	MEASUREMENT	STANDARD (NEW)	SERVICE LIMIT
Transmission	Diameter of needle bearing contact area on main and stator shaft	22.980–22.993 (0.9047–0.9052)	Wear or damage ↑
	Diameter of needle bearing contact area on mainshaft 2nd gear	35.975–35.991 (1.4163–1.4169)	
	Diameter of needle bearing contact area on mainshaft 4th gear collar	31.975–31.991 (1.2588–1.2594)	
	Diameter of needle bearing contact area on mainshaft 1st gear collar	30.975–30.991 (1.2195–1.2201)	
	Diameter of needle bearing contact area on countershaft (R side)	38.505–38.515 (1.5159–1.5163)	
	Diameter of needle bearing contact area on countershaft 3rd gear	31.975–31.991 (1.2589–1.2595)	
	Diameter of needle bearing contact area on countershaft 4th gear	27.980–27.993 (1.1016–1.1021)	
	Diameter of needle bearing contact area on countershaft reverse gear collar	31.975–31.991 (1.2589–1.2595)	
	Diameter of needle bearing contact area on countershaft 1st gear collar	31.975–31.991 (1.2589–1.2595)	
	Diameter of needle bearing contact area on reverse idle gear	13.990–14.000 (0.5508–0.5512)	
	Reverse idler shaft holder I.D.	14.416–14.434 (0.5676–0.5683)	Wear or damage ↓
	Mainshaft 2nd gear I.D.	41.000–41.016 (1.6142–1.6148)	
	Mainshaft 1st gear I.D.	36.000–36.016 (1.4173–1.4180)	
	Countershaft 4th gear I.D.	33.000–33.016 (1.2992–1.2998)	
	Countershaft 3rd gear I.D.	38.000–38.016 (1.4961–1.4967)	
	Countershaft 2nd gear I.D.	31.000–31.016 (1.2205–1.2211)	
	Countershaft 1st gear I.D.	38.000–38.016 (1.4961–1.4967)	
	Countershaft reverse gear I.D.	38.000–38.016 (1.4961–1.4967)	
	Reverse idle gear I.D.	18.007–18.020 (0.7089–0.7094)	
	Mainshaft 4th gear end play	0.10–0.22 (0.0039–0.0087)	
	Mainshaft 2nd gear end play	0.07–0.15 (0.0028–0.0059)	—
	Mainshaft 1st gear end play	0.08–0.24 (0.0031–0.0094)	—
	Countershaft 3rd gear end play	0.07–0.15 (0.0028–0.0059)	—
	Countershaft 2nd gear end play	0.07–0.15 (0.0028–0.0059)	—
	Reverse idler gear end play	0.05–0.18 (0.0020–0.0071)	—
	Countershaft reverse gear end play	0.10–0.25 (0.0039–0.0098)	—
	Reverse gear selector hub O.D.	51.87–51.90 (2.0421–2.0433)	Wear or damage —
	Thrust washer thickness Mainshaft 2nd gear	3.97–4.00 (0.1563–0.1575)	—
	B	4.02–4.05 (0.1583–0.1594)	—
	C	4.07–4.10 (0.1602–0.1614)	—
	D	4.12–4.15 (0.1622–0.1634)	—
	E	4.17–4.20 (0.1642–0.1654)	—
	F	4.22–4.25 (0.1661–0.1673)	—
	G	4.27–4.30 (0.1681–0.1693)	—
	H	4.32–4.35 (0.1701–0.1713)	—
	I	4.37–4.40 (0.1720–0.1732)	—
	Mainshaft right side bearing	2.95–3.05 (0.1161–0.1201)	Wear or damage
	Mainshaft 1st gear	2.43–2.50 (0.0957–0.0984)	Wear or damage
	Countershaft 3rd gear	2.97–3.00 (0.1169–0.1181)	—
	A	3.02–3.05 (0.1189–0.1201)	—
B	3.07–3.10 (0.1209–0.1220)	—	
C	3.12–3.15 (0.1228–0.1240)	—	
D	3.17–3.20 (0.1248–0.1260)	—	
E	3.22–3.25 (0.1268–0.1280)	—	
F	3.27–3.30 (0.1287–0.1299)	—	
G	3.32–3.35 (0.1307–0.1319)	—	
H	3.37–3.40 (0.1327–0.1339)	—	
I	3.37–3.40 (0.1327–0.1339)	—	
Countershaft 4th gear collar thickness	38.97–39.00 (1.5343–1.5354)	—	
1	39.07–39.10 (1.5382–1.5394)	—	
2	39.17–39.20 (1.5421–1.5433)	—	
3	39.27–39.30 (1.5461–1.5472)	—	
4	39.02–39.05 (1.5362–1.5374)	—	
5	39.12–39.15 (1.5402–1.5413)	—	
6	39.22–39.25 (1.5441–1.5453)	—	
7	39.87–39.90 (1.5697–1.5709)	—	
8	39.92–39.95 (1.5717–1.5728)	—	
9	39.92–39.95 (1.5717–1.5728)	—	

9. Automatic Transmission

	MEASUREMENT	STANDARD (NEW)	SERVICE LIMIT			
Transmission (cont'd)	Thrust washer thickness (mainshaft 1st gear L side)	1.45–1.50 (0.0571–0.0591)	1.40 (0.0551)			
	Mainshaft 1st gear collar length	24.50–24.55 (0.9646–0.9665)	—			
	Mainshaft 1st gear collar flange thickness	2.5–2.6 (0.098–0.102)	Wear or damage			
	Countershaft reverse gear collar length	12.00–12.10 (0.4724–0.4764)	—			
	Countershaft reverse gear collar flange thickness	2.40–2.60 (0.0945–0.1024)	Wear or damage			
	Countershaft 1st gear collar length	12.00–12.10 (0.4724–0.4764)	—			
	Countershaft 1st gear collar flange thickness	2.4–2.6 (0.095–0.102)	Wear or damage			
	Diameter of countershaft one-way clutch contact area	83.339–83.365 (3.2811–3.2821)	Wear or damage			
	Diameter of parking gear one-way clutch contact area	66.685–66.698 (2.6254–2.6259)	Wear or damage			
	Mainshaft feed pipe A O.D.	8.97–8.98 (0.353–0.354)	8.95 (0.3524)			
	Mainshaft feed pipe B O.D.	5.97–5.98 (0.2351–0.2354)	5.95 (0.2343)			
	Countershaft feed pipe C O.D.	7.97–7.98 (0.3138–0.3142)	7.95 (0.3130)			
	Mainshaft sealing ring 35 mm thickness	1.980–1.995 (0.0780–0.0785)	1.800 (0.0709)			
	Mainshaft sealing ring 29 mm thickness	1.980–1.995 (0.0780–0.0785)	1.800 (0.0709)			
	Mainshaft bushing I.D.	6.018–6.030 (0.2369–0.2374)	6.045 (0.2380)			
	Mainshaft bushing I.D.	9.000–9.015 (0.3543–0.3549)	9.030 (0.3555)			
	Countershaft bushing I.D.	8.000–8.015 (0.3150–0.3156)	8.030 (0.3161)			
	Mainshaft sealing ring groove width (35 mm and 29 mm)	2.025–2.060 (0.0797–0.0811)	2.080 (0.0819)			
Regulator valve body	Sealing ring contact area diameter	35.000–35.025 (1.3780–1.3789)	35.050 (1.3799)			
Stator shaft	Sealing ring contact area	29.000–29.013 (1.1417–1.1422)	29.05 (1.1437)			
Shifting device and parking brake control	Reverse shift fork thickness	5.90–6.00 (0.2323–0.2362)	5.40 (0.2126)			
	Parking brake ratchet pawl	—	Wear or other defect			
	Parking gear	—	Wear or other defect			
Servo body	Throttle cam stopper	19.5–19.6 (0.768–0.772)	—			
	Shift fork shaft bore I.D.	A 14.000–14.005 (0.5512–0.5514) B 14.006–14.010 (0.5514–0.5516) C 14.011–14.015 (0.5516–0.5518)	— — —			
	Shift fork shaft valve bore I.D.	37.000–37.039 (1.4567–1.4582)	37.045 (1.4585)			
Valve body	Oil pump gear side clearance	0.03–0.05 (0.0012–0.0020)	0.07 (0.0028)			
	Oil pump gear-to-body clearance	Drive: 0.21–0.265 (0.0083–0.0104) Driven: 0.07–0.125 (0.0028–0.0049)	— —			
	Stator camshaft needle bearing contact area I.D. (torque converter side)	27.000–27.021 (1.0630–1.0638)	Wear or damage			
	Stator camshaft needle bearing contact area I.D. (oil pump side)	29.000–29.013 (1.1417–1.1422)	—			
	Oil pump driven gear I.D.	14.016–14.034 (0.5518–0.5525)	Wear or damage			
	Oil pump shaft O.D.	13.980–13.990 (0.5504–0.5508)	Wear or damage			
Spring	STANDARD (NEW)					
		Wire Dia.	O.D.	Free Length	No. of Coils	
	1st one-way ball spring	0.29 (0.01)	4.0 (0.16)	14.0 (0.55)	13.0	
	Idle shaft spring A	0.7 (0.03)	5.7 (0.22)	14.6 (0.57)	7.0	
	Idle shaft spring B	0.8 (0.03)	5.6 (0.22)	20.7 (0.81)	11.5	
	Regulator valve spring A	Carbureted	1.8 (0.07)	14.7 (0.58)	85.1 (3.35)	16.5
		Fuel-Injected	1.8 (0.07)	14.7 (0.58)	88.6 (3.49)	16.5
	Regulator valve spring B	1.8 (0.07)	9.6 (0.38)	44.0 (1.73)	7.5	
	Stator reaction spring	6.0 (0.24)	38.4 (1.51)	30.3 (1.19)	2.0	
	Torque converter check valve spring	1.1 (0.04)	8.4 (0.33)	36.3 (1.43)	12.5	
	Relief valve spring	0.9 (0.04)	8.4 (0.33)	57.8 (2.28)	20.2	
	Cooler check valve spring	1.1 (0.04)	8.4 (0.33)	46.8 (1.84)	17.0	
	2nd orifice control spring	0.8 (0.03)	6.6 (0.26)	46.9 (1.85)	35.1	
	Servo orifice control spring	0.8 (0.03)	6.1 (0.24)	40.0 (1.57)	20.1	
	4th exhaust spring	0.9 (0.04)	5.6 (0.22)	34.1 (1.34)	19.3	
	Throttle valve adjusting spring	0.8 (0.03)	6.5 (0.26)	30.0 (1.18)	8.0	
	Throttle B spring	1.4 (0.06)	8.5 (0.33)	41.4 (1.63)	8.4	
		1.4 (0.06)	8.5 (0.33)	41.4 (1.63)	7.8	
		1.6 (0.06)	8.5 (0.33)	41.3 (1.63)	13.9	
	1–2 shift spring	1.0 (0.04)	9.6 (0.38)	41.5 (1.63)	14.0	
3–4 shift spring	0.8 (0.03)	7.6 (0.30)	50.8 (2.00)	16.0		
2–3 shift spring	0.8 (0.03)	7.6 (0.30)	50.8 (2.00)	16.0		

(cont'd)

Standards and Service Limits (cont'd)

Unit: mm (in)

9. Automatic Transmission (cont'd)

Spring (cont'd)	MEASUREMENT	STANDARD (NEW)			
		Wire Dia.	O.D.	Free Length	No. of Coils
	1st accumulator spring A	2.8 (0.11)	21.5 (0.85)	56.2 (2.21)	8.9
	1st accumulator spring B	2.8 (0.11)	9.8 (0.39)	42.0 (1.65)	9.2
	4th accumulator spring	3.2 (0.13)	18.6 (0.73)	79.0 (3.11)	13.2
	2nd accumulator spring	2.8 (0.11)	16.5 (0.65)	85.0 (3.35)	15.3
	3rd accumulator spring	2.7 (0.11)	16.0 (0.63)	75.9 (2.99)	13.2
	Lock-up shift spring	0.9 (0.04)	7.6 (0.30)	73.7 (2.90)	32.0
	Lock-up timing spring	0.8 (0.03)	6.6 (0.26)	60.8 (2.39)	40.0
	Lock-up control spring	0.7 (0.03)	6.6 (0.26)	38.0 (1.50)	14.1
	C,D,E Carbureted A,B,C Fuel-Injected	0.7 (0.03)	6.6 (0.26)	38.0 (1.50)	14.1
	CPC valve spring	1.4 (0.06)	9.4 (0.37)	36.6 (1.44)	12.6
	Modulator valve spring	1.4 (0.06)	9.4 (0.37)	32.4 (1.28)	10.5
	3rd kick-down spring	0.9 (0.04)	6.6 (0.26)	63.5 (2.50)	31.1
	Servo control spring	1.0 (0.04)	8.1 (0.32)	42.0 (1.65)	16.5
	3-2 kick down valve spring	1.0 (0.04)	6.4 (0.25)	37.1 (1.46)	19.2

9. Differential

	MEASUREMENT	STANDARD (NEW)	SERVICE LIMIT
Ring gear	Backlash	0.087-0.146 (0.0034-0.0057)	0.2 (0.0079)
Differential carrier	Pinion shaft bore diameter	18.000-18.018 (0.7087-0.7094)	18.1 (0.71)
	Carrier-to-pinion shaft clearance	0.017-0.047 (0.0007-0.0019)	0.1 (0.004)
	Driveshaft bore diameter	28.005-28.025 (1.1025-1.1033)	—
	Carrier-to-driveshaft clearance	0.025-0.066 (0.0010-0.0026)	0.12 (0.005)
Differential pinion gear	Backlash	0.05-0.15 (0.002-0.006)	Adjust with a washer.
	Pinion gear bore diameter	18.042-18.066 (0.7103-0.7113)	—
	Pinion gear-to-pinion shaft clearance	0.059-0.095 (0.0023-0.0037)	0.15 (0.006)
Differential taper roller bearing	Preload	2.8-4.0 N·m (28-40 kg-cm, 24-35 lb-in) at new bearing 2.5-3.7 N·m (25-37 kg-cm, 22-32 lb-in) at old bearing	Adjust with a shim.

10. Driveshafts

	MEASUREMENT	STANDARD (NEW)	SERVICE LIMIT
Driveshaft	Right boot	As installed	—
	Left boot	As installed	—

11. Power Steering

	MEASUREMENT	STANDARD (NEW)	SERVICE LIMIT
Steering wheel	Play	10 (0.39) Max.	—
	Pinion starting torque N·m (kg-m, ft-lb)	1.2 (0.12, 0.86)	—
Power steering	Angle of rack-guide-screw loosened from locked position	25° ± 5° (2WS), 35° ± 5° (4WS)	—
	Pump pressure with valve closed (Oil temp./ speed: 40°C (104°F) min/idle. Do not run for more than 5 seconds) kPa (kg/cm², psi)	7845-8826 (80-90, 1138-1280)	—
	Fluid capacity Reservoir At change	0.5 ℓ (0.53 U.S. qt., 0.44 Imp. qt.) approx 1.7 ℓ (1.8 U.S. qt., 1.5 Imp. qt.)	—
Power steering belt	Deflection midway between pulleys/load	11-13 (0.43-0.51)/98N (10 kg/22 lb) for used belt 9-11 (0.35-0.43)/98N (10 kg/22 lb) after replacement of belt	—
Tie-rod end	Moving effort (maximum load measured at the pin hole at the tip of tie-rod end)	Front	14.6 lbs, (6.6 kg)
		Rear	14.6 lbs, (6.6 kg)

12. Suspension

□ : Rear wheel with 4WS Unit: mm (in).

		MEASUREMENT	STANDARD (NEW)	SERVICE LIMIT
Wheel alignment	Camber		Front 0°00' ± 1°	Rear -0°20' ± 1° (□-0°20' ± 30')
			2°20' ± 30'	
	Caster		0 ± 2 (0 ± 0.08)	2 ± 2 (0.08 ± 0.08)
	Toe-in		0 ± 2 (0 ± 0.08)	IN 2 ± 2 (IN 0.08 ± 0.08)
	Side slip		0 ± 2 (0 ± 0.08)	IN 2 ± 2 (IN 0.08 ± 0.08)
	Turning angle (MAX.)	Inward wheel Outward wheel	37°20' ± 2° (□5°00' ± 1°) 30°15' ± 2° (□5°20' ± 1°)	
	△ Rear wheel turning angle (when steering wheel angle is at 127°)		□1°30' ± 30'	
Ball joint	Moving effort (Maximum load measured at the pin rock at the tip of tie-rod end)	Front/Upper Front/Lower Rear/Upper Rear/Lower	10.4 lbs. (4.7 kg) 7.9 lbs. (3.6 kg) 7.7 lbs. (3.5 kg) 13.9 lbs. (6.3 kg)	
Wheel	Rim runout	Steel	0—1.0 (0—0.039)	—
		Aluminum	0—0.3 (0—0.012)	—
	Pitch-circle diameter Offset		100 (3.94) 45 (1.77)	
Wheel bearing	End play	Front	0	0.05
		Rear	0	0.05

△: Maximum steering angle at which front and rear wheel in place.

13. Brake

O: Fuel-Injected Engine ●: Carbureted Engine

		MEASUREMENT	STANDARD (NEW)	SERVICE LIMIT
Parking brake lever		Play in stroke 200N (20 kg, 44 lbs)	To be locked when pulled 7—11 notches	
Foot brake pedal	Pedal height	M/T H/M	178 (7.0) 183 (7.2) from floor	— —
	Free play		1—5 (0.04—0.20)	5 (0.20)
Master cylinder		Piston-to-push rod clearance	0—0.4 (0—0.016)	—
Disc brake	Disc thickness	Front	○ 21.0 (0.83) ● 19.0 (0.75)	19.0 (0.75) 17.0 (0.67)
		Rear	10.0 (0.39)	8.0 (0.31)
	Disc runout	Front/Rear	—	0.10 (0.004)/0.15 (0.006)
	Disc parallelism		—	0.015 (0.0006)
	Pad thickness	Front	○ 11.5 (0.45) ● 9.0 (0.35)	3.0 (0.12) 3.0 (0.12)
	Rear	8.0 (0.31)	2.0 (0.08)	
Brake booster	Characteristics	Vacuum (mm Hg)	Pedal Pressure kg (lbs)	Line Pressure kg/cm ² (psi)
		0	20 (44)	○ 11.4 (162) ● 13.1 (186)
		300	20 (44)	○ 47.8 (680) ● 54.9 (781)
		500	20 (44)	○ 72.3 (1,028) ● 83.0 (1,180)

(cont'd)

Standards and Service Limite (cont'd)

16. Electrical

O: Fuel-Injected Engine

●: Carbureted Engine

Unit: mm (in.)

MEASUREMENT		STANDARD (NEW)		
Ignition	Rated voltage	12 Volts		
	Primary winding resistance	1.2–1.5 ohms		
	Secondary winding resistance	9,040–13,560 ohms		
Ignition wire	Resistance	25,000 ohms max.		
Spark plug	Type	Fuel-injected engine:		
		KX, KQ, KS, KG	BCPR6EY-N11 (NGK) BCPR6E-11 (NGK) Q20PR-U11 (ND)	*1
			BCPR5EY-N11 (NGK) BCPR5E-11 (NGK)	*2
			BCPR7EY-N11 (NGK) BCPR7E-11 (NGK) Q22PR-U11 (ND)	*3
		KE, KB, KF, KT, KW, KY	BCPR6E-11 (NGK) Q20PR-UL11 (ND) Q20PR-U11 (ND)	*1
			BCPR5E-11 (NGK) Q16PR-UL11 (ND) Q16PR-U11 (ND)	*2
			BCPR7E-11 (NGK) Q22PR-UL11 (ND) Q22PR-U11 (ND)	*3
		Carbureted engine:		
		KE, KB, KF, KT, KW, KY	BCPR6E-11 (NGK) Q20PR-U11 (ND) Q20PR-UL11 (ND)	*1
			BCPR5E-11 (NGK) Q16PR-U11 (ND) Q16PR-UL11 (ND)	*2
BCPR7E-11 (NGK) Q22PR-U11 (ND) Q22PR-UL11 (ND)	*3			
KX, KS, KG	BCPR6EY-N11 (NGK) BCPR6E-11 (NGK) Q20PR-U11 (ND)	*1		
	BCPR5EY-N11 (NGK) BCPR5E-11 (NGK)	*2		
	BCPR7EY-N11 (NGK) BCPR7E-11 (NGK) Q22PR-U11 (ND)	*3		
Gap	1.0–1.1 (0.039–0.043)			
Ignition timing	At idling	○ Manual ○ Automatic (in neutral)	15 ± 2° BTDC	
			15 ± 2° BTDC	
		● Manual ● Automatic (in neutral)	15 ± 2° BTDC (KT, KY) 16 ± 2° BTDC (KB, KE, KF, KG, KW) 20 ± 2° BTDC (KS, KX)	
			10 ± 2° BTDC (KT, KY) 15 ± 2° BTDC (KS, KX) 16 ± 2° BTDC (KB, KE, KF, KG, KW)	
Battery	Lighting capacity (20-hour ratio)	65 Ampere hours (European Models) 65, 47 Ampere hours (General Models)		
	Starting capacity (5-second ratio)	9.2 V minimum at 300 Ampere draw (European Models) 8.5 V minimum at 300 Ampere draw (General Models)		
Alternator	Output	13.5 V/70 A		
	Coil resistance (rotor)	2.8–3.0 ohms		
	Slip ring O.D.	14.4 (0.57)		
	Brush length	10.5 (0.41)		
Starting motor	MEASUREMENT	1.0 kW (KE, KQ, KT, KY) 1.4 kW (Except KE, KQ, KT, KY)		
		STANDARD (NEW)	SERVICE LIMIT	
	Mica depth	0.4–0.5 (0.016–0.020)	0.15 (0.006)	
	Commutator runout	0–0.02 (0.0008)	0.05 (0.002)	
	Commutator O.D.	28.0–28.1 (1.102–1.106)	27.5 (1.08)	
	Brush length	15.8–16.2 (0.62–0.64)	10.0 (0.39)	
	Spring pressure (new)	15.7–17.7 N (1.6–1.8 kg, 3.5–4.0 lb)	—	

Design Specifications

	ITEMS	METRIC	ENGLISH	NOTE	
DIMENSIONS	Overall Length	4,510 mm	177.6 in.	KQ except KQ	
	Overall Width	1,710 mm	67.3 in.		
		1,695 mm	66.7 in.		
	Overall Height	1,295 mm	51.0 in.		
	Wheelbase	2,565 mm	101.0 in.		
	Track F/R	1,480/1,470 mm	58.3/57.9 in.		
	Ground Clearance	145 mm	5.7 in.		
	Seating Capacity		Four		
	Overhang F/R	905/1,040 mm	35.6/40.9 in.		Includes bumper

European Model

WEIGHT						
	Curb weight	2.0 Carbureted without CATA	5M/T	1,100 kg	2,425 lb	KF, KB, KW
			4A/T	1,105 kg	2,436 lb	
	2.0 Carbureted with CATA	5M/T	4A/T	1,120 kg	2,469 lb	KF, KB, KW
			4A/T	1,125 kg	2,480 lb	KE
		5M/T	4A/T	1,115 kg	2,458 lb	KX, KW, KS
			4A/T	1,110 kg	2,447 lb	KG
	2.0 Fuel-Injected without CATA	5M/T	4A/T	1,135 kg	2,502 lb	KX, KW, KS
			4A/T	1,130 kg	2,491 lb	KG
		5M/T	4A/T	1,155 kg	2,546 lb	KF
			4A/T	1,145 kg	2,524 lb	KB, KE
		5M/T	4A/T	1,140 kg	2,513 lb	KW
			4A/T	1,175 kg	2,590 lb	KF
	2.0 Fuel-Injected with CATA	5M/T	4A/T	1,165 kg	2,568 lb	KB, KE
			4A/T	1,160 kg	2,557 lb	KW
		5M/T	4A/T	1,165 kg	2,568 lb	KX
			4A/T	1,150 kg	2,535 lb	KG, KW, KS
		5M/T	4A/T	1,185 kg	2,612 lb	KX
			4A/T	1,170 kg	2,579 lb	KG, KW, KS

CATA: Catalytic converter

General Model (KQ)

WEIGHT					
	Curb weight	2.0 Fuel-Injected	5M/T	1,170 kg	2,579 lb
			4A/T	1,190 kg	2,623 lb

General Model (KY)

WEIGHT					
	Curb weight	2.0 Carbureted	5M/T	1,180 kg	2,601 lb
			4A/T	1,200 kg	2,646 lb
	2.0 Fuel-Injected	5M/T	4A/T	1,220 kg	2,690 lb
			4A/T	1,240 kg	2,734 lb
		5M/T	4A/T	1,235 kg	2,723 lb
			4A/T	1,255 kg	2,767 lb

with 4WS
with 4WS

General Model (KT)

WEIGHT					
	Curb weight	2.0 Carbureted	5M/T	1,100 kg	2,425 lb
			4A/T	1,120 kg	2,469 lb
	2.0 Fuel-Injected	5M/T	4A/T	1,145 kg	2,524 lb
			4A/T	1,165 kg	2,568 lb

M/T: Manual Transmission, A/T: Automatic Transmission

(cont'd)

Design Specifications (cont'd)

European Model

WEIGHT	ITEMS		METRIC	ENGLISH	NOTE
WEIGHT	Weight distribution (Front/Rear) 2.0 Carbureted without CATA	5M/T	665/435 kg	1,466/959 lb	KF, KB, KW
		4A/T	665/440 kg	1,466/970 lb	
	2.0 Carbureted with CATA	5M/T	685/435 kg	1,510/959 lb	KF, KB, KW
		4A/T	685/440 kg	1,510/970 lb	
	2.0 Fuel-Injected without CATA	5M/T	675/440 kg	1,488/970 lb	KX, KW
		4A/T	675/435 kg	1,488/959 lb	
	2.0 Fuel-Injected with CATA	5M/T	685/435 kg	1,510/959 lb	KF, KB, KW
		4A/T	695/440 kg	1,532/970 lb	
	2.0 Fuel-Injected without CATA	5M/T	696/435 kg	1,532/959 lb	KF, KB, KW
		4A/T	700/435 kg	1,543/959 lb	
	2.0 Fuel-Injected with CATA	5M/T	705/450 kg	1,554/992 lb	KF, KB, KE
		4A/T	695/450 kg	1,532/992 lb	
	2.0 Fuel-Injected with CATA	5M/T	695/445 kg	1,532/981 lb	KF, KB, KE
		4A/T	725/450 kg	1,598/992 lb	
	2.0 Fuel-Injected with CATA	5M/T	715/450 kg	1,576/992 lb	KF, KB, KE
		4A/T	715/445 kg	1,576/981 lb	
	2.0 Fuel-Injected with CATA	5M/T	715/450 kg	1,576/992 lb	KX, KW
		4A/T	700/450 kg	1,543/992 lb	
	2.0 Fuel-Injected with CATA	5M/T	695/455 kg	1,532/1,003 lb	KX, KW
		4A/T	700/450 kg	1,543/992 lb	
2.0 Fuel-Injected with CATA	5M/T	735/450 kg	1,620/992 lb	KX, KW	
	4A/T	720/450 kg	1,587/992 lb		
2.0 Fuel-Injected with CATA	5M/T	715/455 kg	1,576/1,003 lb	KX, KW	
	4A/T	720/450 kg	1,587/992 lb		

CATA: Catalytic converter

General Model (KQ)

WEIGHT	ITEMS		METRIC	ENGLISH	NOTE
WEIGHT	Weight distribution (Front/Rear) 2.0 Fuel-Injected	5M/T	705/465 kg	1,554/1,025 lb	
		4A/T	725/465 kg	1,598/1,025 lb	

General Model (KY)

WEIGHT	ITEMS		METRIC	ENGLISH	NOTE	
WEIGHT	Weight distribution (Front/Rear) 2.0 Carbureted	5M/T	710/470 kg	1,565/1,036 lb		
		4A/T	735/465 kg	1,620/1,025 lb		
	2.0 Fuel-Injected	5M/T	740/480 kg	1,631/1,058 lb		
		4A/T	760/480 kg	1,675/1,058 lb		
	2.0 Fuel-Injected	5M/T	745/490 kg	1,642/1,080 lb		with 4WS
		4A/T	765/490 kg	1,687/1,080 lb		

General Model (KT)

WEIGHT	ITEMS		METRIC	ENGLISH	NOTE
WEIGHT	Weight distribution (Front/Rear) 2.0 Carbureted	5M/T	660/440 kg	1,455/970 lb	
		4A/T	680/440 kg	1,499/970 lb	
	2.0 Fuel-Injected	5M/T	695/450 kg	1,532/992 lb	
		4A/T	715/450 kg	1,576/992 lb	

M/T: Manual Transmission, A/T: Automatic Transmission

	ITEMS		METRIC		ENGLISH		NOTE
ENGINE	Type	Fuel-Injected Carbureted	Water cooled, 4-stroke gasoline engine D.O.H.C. Water cooled, 4-stroke gasoline engine S.O.H.C.				
	Cylinder Arrangement		4-cylinder in line, transverse				
	Bore and Stroke		81 x 95 mm		3.19 x 3.74 in.		
	Displacement		1,958 cm ³ (cc)		119 cu in.		
	Compression Ratio	Fuel-Injected	9.4 (KS, KX, KZ, KQ), 9.5 (KY, KT)				
		Carbureted	10.5 (KB, KE, KF, KW)				
	Valve Train	Fuel-Injected	9.1 (KS, KX KZ), 9.2 (KB, KE, KF, KT, KW, KY)				
		Carbureted	4-valve per cylinder, dual overhead camshafts				
	Lubrication System		3-valve per cylinder, single overhead camshaft				
	Fuel Required	EX (KG, KS) and KQ 16i (KG, KS, KX) and KE KT, KY KB, KF, KW	Forced and wet sump Unleaded gasoline with 91 R.O.N. or higher Unleaded gasoline with 95 R.O.N. or higher Leaded gasoline with 91 R.O.N. or higher Leaded gasoline with 98 R.O.N. or higher or unleaded gasoline with 95 R.O.N. or higher				
	Engine wet Weight	Fuel-Injected	126 kg		278 lb.	except radiator, transmission	
		Carbureted	123 kg		271 lb.		
STARTER	Type	mitsuba	Gear reduction				
	Normal output		1.0 kW (KE, KQ, KT, KY)		1.4 kW (except KE, KQ, KT, KY)		
	Normal voltage		12 V				
	Hour rating		30 seconds				
	Direction of rotation		Clockwise as viewed from gear end				
	Weight	mitsuba	3.5 kg		7.7 lb.		
TRANSMISSION	Clutch	5-M/T 4-A/T	Single plate dry, diaphragm spring.				A: Carbureted B: Fuel-Injected (KG, KS, KX, KQ) C: Fuel-Injected (KE, KF, KB, KW) D: Carbureted E: Fuel-Injected (KG, KS, KQ) F: Fuel-Injected (KE, KF, KB, KW) G: Fuel-Injected (KX)
	Transmission	5-M/T 4-A/T	Torque converter 5-speed forward, 1 reverse. 4-speed forward, 1 reverse.				
	Primary Reduction		1.000				
	Gear Ratio (5 M/T)		A	B	C		
	Shift position	1st	3.307	←	←		
		2nd	1.809	←	1.772		
		3rd	1.269	1.230	1.210		
		4th	0.964	←	←		
		5th	0.812	←	←		
		Reverse	3.000	←	←		
	Gear Ratio (4 A/T)		D	E	F	G	
	Shift position	1st	2.647	←	2.529	2.647	
		2nd	1.444	1.392	←	1.344	
		3rd	1.030	1.060	1.030	1.060	
		4th	0.763	←	←	←	
		Reverse	1.904	←	←	←	
	Final Reduction	5-M/T	Fuel-Injected, carbureted (KT, KY): Single helical gear, 4.062				
		4-A/T	Carbureted (except KT, KY): Single helical gear, 4.266				
			Single helical gear, 4.066				
	Clutch Facing Area		176 cm ²	27.3 sq. in.			

M/T: Manual Transmission A/T: Automatic Transmission

(cont'd)

Design Specifications (cont'd)

	ITEMS	METRIC	ENGLISH	NOTE	
AIR CONDITIONER	Cooling Capacity	2,915 Kcal/h	11,566 BTU/h		
	— Conditions:				
	Compressor min ⁻¹ (rpm)	1,800 min ⁻¹ (rpm)			
	Outside air temperature	27.0°C	80.6°F		
	Outside air humidity	50%			
	Condenser air temperature	35°C	95°F		
	Condenser air velocity	4.5 m/sec.	14.8 ft/sec.		
	Blower capacity	390 m ³ /h	13,773 cu. ft/h		
	Compressor	Type No. of vanes Displacement Max. min ⁻¹ (rpm) Lubricant/capacity	130 cc/rev. 7,000 min ⁻¹ (rpm) 130 cc	Rotary type 3 7.93 cu. in/rev. 4.39 US oz.	
	Receiver Dryer	With dessicant	Includes fusible safety plug.		
Condenser		Corrugated fin type			
Evaporator		Corrugated fin type			
Blower	Type Motor input Speed control Max. capacity	390 m ³ /h	Sirocco fan 145 W (12 V) 4 position 13,773 cu ft/h		
Temp. Control		Air-mix type			
Comp. Clutch	Type Power consumption		Dry, single plate, V-belt 48 W max. 12 V		
Refrigerant	Type Quantity RHD LHD	0.85 ± 0.05 kg 0.90 ± 0.05 kg	R-12 1.76 ± 0.11 lbs 1.98 ± 0.11 lbs		
STEERING SYSTEM	Type Overall Ratio Turns, lock-to-lock Steering Wheel Dia. Power Steering Oil Capacity Power Steering Oil	370 mm 1.7 lit.	Rack and Pinion 14.9 : 1 2.84 14.6 in. 1.8 U.S. qt., 1.5 Imp qt. HONDA Genuine Power Steering Fluid P/N 08208—99961		
SUSPENSION SYSTEM	Type, Front/Rear Shock Absorber Front/Rear	Independent by double wishbones, coil springs Telescopic, hydraulic			
WHEEL ALIGNMENT	Wheel alignment Camber Front Rear Caster Front Toe-in Front Rear Kingpin Inclination	0 mm 2 mm	0° -0°20' 2°20' 9°45' 0 in. 0.080 in.		
BRAKE SYSTEM	Type, Front/Rear Pad Surface Area: Front/Rear Effective Disc Dia. Front Rear Parking Brake Kind and Type		Power assisted self-adjusting ventilated disc ○ 43.3/21.0 cm ² 6.7/3.3 sq. in. ● 35.8/20.9 cm ² 5.5/3.2 sq. in. ○ 214 mm 8.4 in. ● 194 mm 7.6 in. 208 mm 8.2 in. Mechanical actuating, rear two wheel brakes		
TIRES	Front/Rear Spare		○ 195/60VR 14 (except KY) ○ 195/60 R14 85V (KY only) ● 185/70R 13 85H ● 185/70R 13 86H (KF, KS, KW, KE only) T135/70D 15 (KE (all) and with ALB) ○ T105/70D 14 (KS, KW, KB without ALB) ● T105/80D 13 (except KE, KY, KT without ALB)		

○: Fuel-Injected model ●: Carbureted Model

	ITEMS	METRIC	ENGLISH	NOTE
ELECTRICAL	Battery	80D: 12 V-65 AH, MF	70D: 12 V-65 AH, MF	European Models General Models
	Starter		70D: 12 V-65 AH, MF	
	Alternator		55B: 12 V-47 AH, MF	
	Fuses In the fuse box		12 V-1.4 kW	
	In the relay box		12 V-70 amps	
	Headlights High/Low		7.5 A, 10 A, 15 A, 20 A, 30 A	
	Day Time Running Lights		10 A, 15 A, 20 A, 30 A, 40 A, 70 A	
	Passing Lights		12 V-60/55 W	
	Front Turn Signal Lights		12 V-21 W (KW), 55 W (KS)	
	Rear Turn Signal Lights		12 V-55 W	
	Side Turn Signal Lights		12 V-21 W	
	Stop/Taillights		12 V-21 W	
	Side Marker Lights		12 V-5 W	
	Rear Fog Lights		12 V-21 W	
	Back-up Lights		12 V-21 W	
	License Plate Lights		12 V-5 W, 8 W	
	Gauge Lights		12 V-3.4 W, 1.4 W	
	Indicator Lights		12 V-1.4 W	
	Warning Lights		12 V-1.4 W	
	Glove Box Lights		12 V-3.4 W	
Dome Light		12 V-8 W		
Trunk Light		12 V-3.4 W		
Fuse Box Light		12 V-3.4 W		
Illumination and Pilot Lights		12 V-1.4 W, 1.2W		
Heater Illumination Lights		0.91 W, 0.56 W, LED		
				Austrian Model



Body Specifications

Unit: mm (in.)

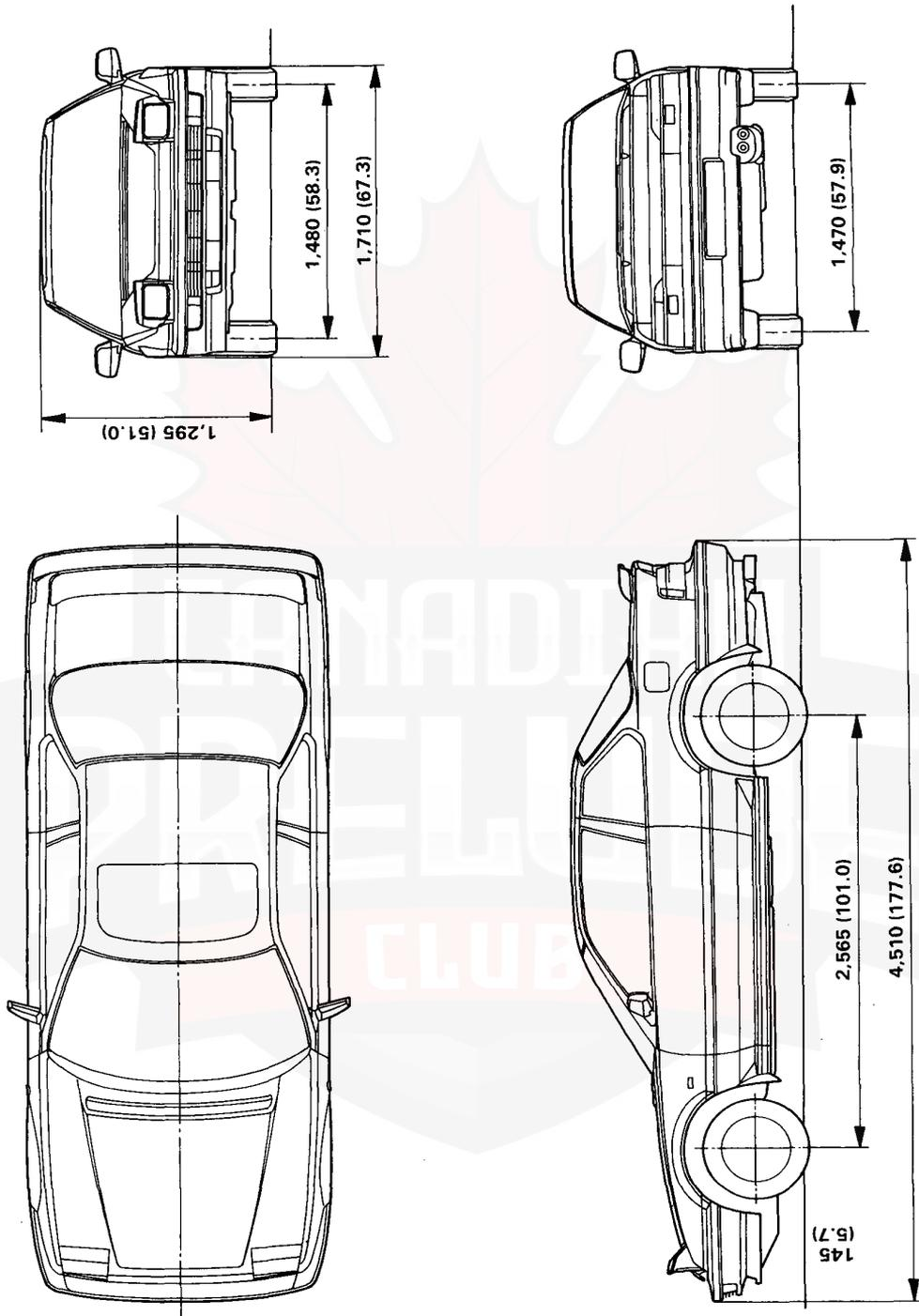

Maintenance

Lubrication Points	4-2
Maintenance Schedule	4-4

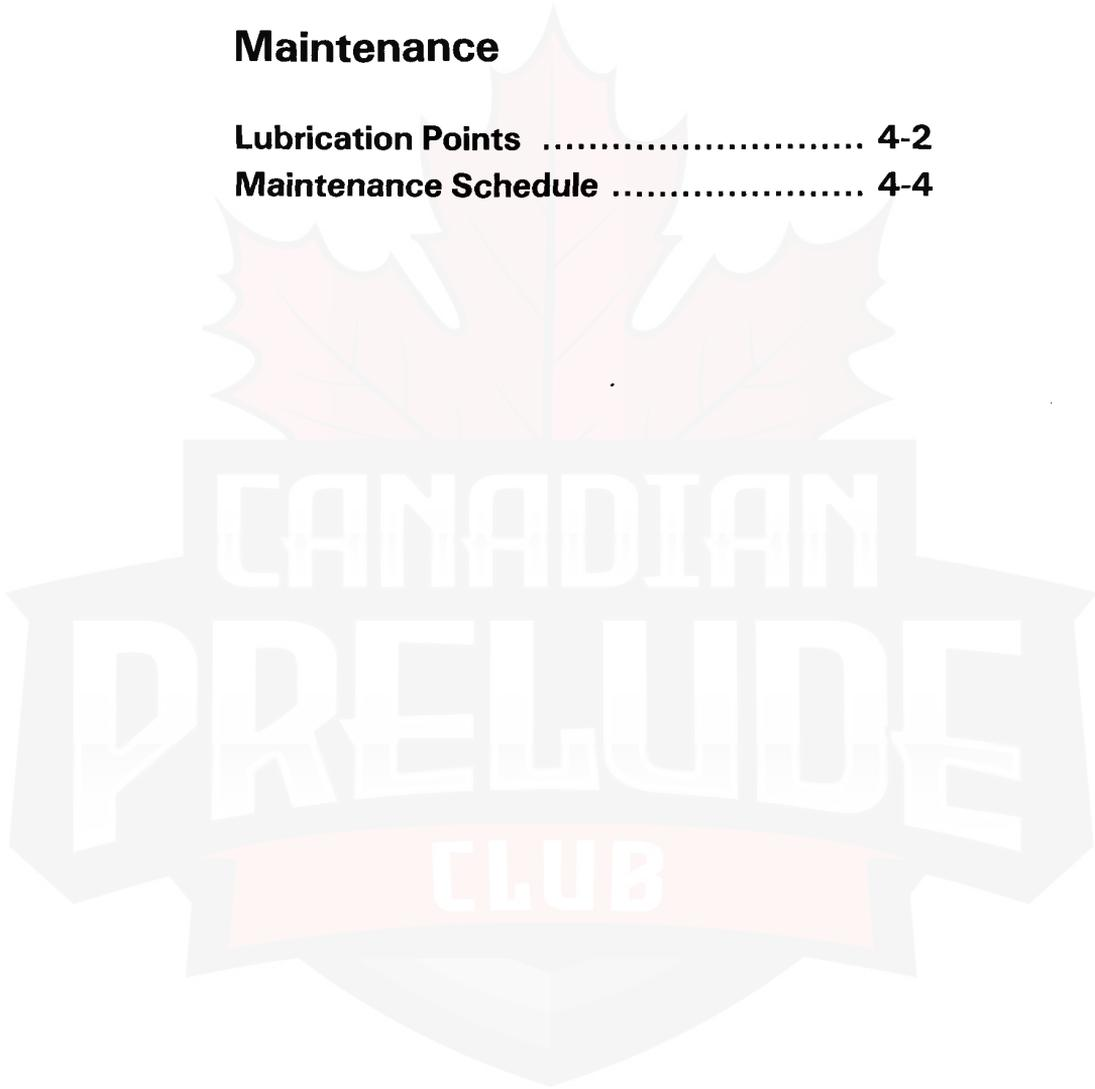

Lubrication Points

No.	LUBRICATION POINTS	LUBRICANT
1	Engine	API Service Grade: SE, SF or SG SAE Viscosity: See chart below
2	Transmission Manual Automatic	API Service Grade: SE or SF SAE Viscosity: See chart below DEXRON® or DEXRON® II Automatic transmission fluid
3	Brake line (Including ALB line for ALB models)	Brake fluid Dot 3 or Dot 4
4	Clutch line	Brake fluid DOT 3
5	Steering gearbox (Power steering)	Honda steering grease P/N 08733—B070E
6	Steering ball joint	Multi-purpose Grease
7	Suspension ball joints	
8	Steering boot	
9	Shift lever pivot (Manual steering)	
10	Steering column bushings	
11	Select lever (Automatic transmission)	
12	Pedal linkage	
13	Brake master cylinder push rod	
14	Trunk hinges	
15	Door hinges upper and lower	
16	Door opening detents	
17	Fuel filler lid	
18	Engine hood hinges	
19	Engine hood latch	
20	Retractable headlight mechanism	
21	Caliper Piston seal Dust seal Caliper pin Piston	Silicone Grease
22	Power steering system	Honda power steering fluid P/N 08208—99961

Recommended Engine Oil
(SE, SF or SG Grade)

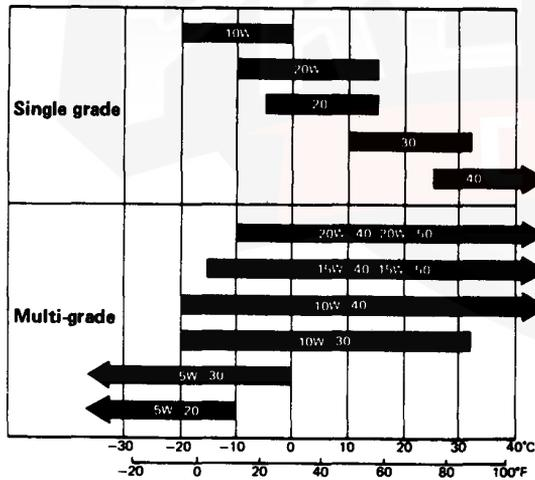

Engine oil viscosity for ambient temperature ranges.

Recommended Manual Transmission Oil
(SE or SF Grade)

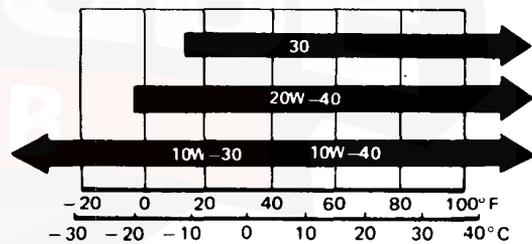

Transmission oil viscosity for ambient temperature ranges.

CAUTION: Used engine oil may cause skin cancer if repeatedly left in contact with the skin for prolonged periods. Although this is unlikely unless you handle used oil on a daily basis, it is still advisable to thoroughly wash your hands with soap and water as soon as possible after handling used oil.

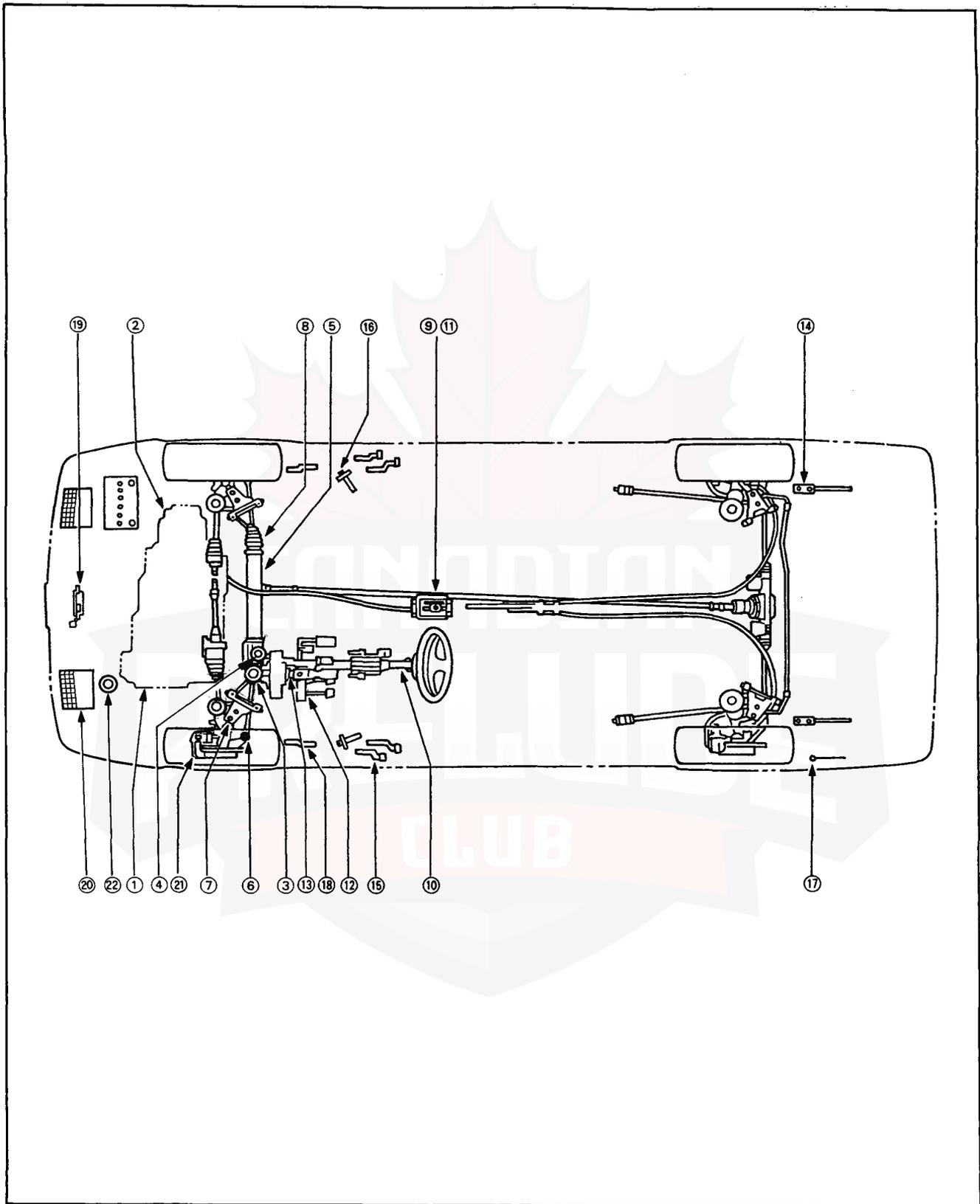

Maintenance Schedule

Service at the interval of listed x 1,000 km (or miles) or after that number of months, whichever comes first.						
ITEMS	x 1,000 km	20	40	60	80	100
	x 1,000 miles	12	24	36	48	60
	months	12	24	36	48	60
Idle speed and idle CO (except KS, KX types)		I	I	I	I	I
Idle speed and idle CO (KS, KX types)						I
Valve clearance		I	I	I	I	I
Alternator drive belt			I		I	
Timing belt						R
Water pump						I
■ Engine oil and oil filter	Replace every 10,000 km (6,000 miles) or 6 months					
■ Transmission oil			R		R	
■ Radiator coolant					R ¹	
Cooling system, hoses and connections			I		I	
E.G.R. system (for cars using unleaded gasoline) ²						I
Secondary air supply system (for carburetor type) ³						I
Air cleaner element (dry type) ⁴		R	R	R	R	R
Air cleaner element (viscous type) ⁵			R		R	
Fuel filter (including aux. filter for carburetor type)			R		R	
Intake air temp. control system (for carburetor type)						I
Tank, fuel line and connection			I		I	
Throttle control system (for carburetor type, except KS, KX types)			I		I	
Throttle control system (for carburetor type, KS, KX types)						I
Choke mechanism (for carburetor type, except KS type)			I		I	
Choke mechanism (for carburetor type, KS type only)				C ¹⁸		I
Choke opener operation (for carburetor type)						I
Evaporative emission control system ⁶						I
Ignition timing and control system (except KS, KX types)			I		I	
Ignition timing and control system (KS, KX types)						I
Spark plug (for cars using unleaded gasoline)			R ⁷		R ⁷	
Spark plug (for cars using leaded gasoline)		R	R	R	R	R
Distributor cap and rotor (except KS, KX types)			I		I	
Distributor cap and rotor (KS, KX types)						I
Ignition wiring (except KS, KX types)			I		I	
Ignition wiring (KS, KX types)						I
Positive crankcase ventiration valve (except KS, KX types)			I		I	
Positive crankcase ventiration valve (KS, KX types)						I
Blow-by filter (for carburetor type)			I		I	
Brake hoses and lines (including ALB hoses and pipes for ALB models)		I	I	I	I	I
Brake fluid (including ALB fluid for ALB models)			R		R	
Front brake discs and calipers		I	I	I	I	I
Front brake pads	Inspect every 10,000 km (6,000 miles) or 6 months					
Rear brake discs, calipers and pads			I		I	
Parking brakes		I	I		I	
Exhaust pipe and muffler		I	I	I	I	I
Suspension mounting bolts		I	I	I	I	I
Front wheel alignment (except 4WS models)		I	I	I	I	I
Front and rear wheel alignment (for 4WS models)		I	I	I	I	I
Steering operation, tie rod ends, steering gear box and boots (including center shaft for 4WS models)	except 4WS models	I	I		I	
	for 4WS models	I	I	I	I	I
ALB high pressure hose (for ALB models)					R	
ALB operation (for ALB models)		I	I		I	
Power steering system		I	I	I	I	I
Power steering pump belt			I		I	
Catalytic converter heat shield (car equipped with catalytic converter)						I

R—Replace I—Inspect. After inspection, clean, adjust, repair or replace if necessary
C—Clean

■: These service intervals assume routine checking and replenishment has been done, as needed, by the customer.

¹ Thereafter, replace every 2 years or 40,000 km (24,000 miles), whichever comes first.

² Except KQ type.

³ For cars using unleaded gasoline.

⁴ Except European and KQ types.

⁵ For European and KQ types.

⁶ For cars using unleaded gasoline, carburetor type using leaded gasoline and KY type.

⁷ For KS type, replace every 2 years or 40,000 km (24,000 miles) whichever comes first after 30,000 km (18,000 miles).

⁸ Recommended by manufacturer only.



CAUTION: The following items must be serviced more frequently on cars normally used under severe driving conditions. Refer to the chart below for the appropriate maintenance intervals.

Severe driving conditions include:

A: Repeated short distance driving

B: Driving in dusty conditions

C: Driving in severe, cold weather

D: Driving in areas using road salt or other corrosive materials

E: Driving on rough and/or muddy roads

F: Towing a trailer

R—Replace

I —Inspect. After inspection, clean, adjust, repair or replace if necessary.

Condition	Maintenance item	Maintenance operation	Interval
A, B, F	Engine oil and oil filter	R	Every 5,000 km (3,000 miles) or 3 months
F	Transmission oil	R	Every 20,000 km (12,000 miles) or 12 months
A, B, D, E, F	Front brake discs and calipers	I	Every 10,000 km (6,000 miles) or 6 months
A, B, D, E, F	Rear brake discs, calipers and pads	I	Every 20,000 km (12,000 miles) or 12 months
B, C, E	Power steering system	I	Every 10,000 km (6,000 miles) or 6 months

CAUTION: Used engine oil may cause skin cancer if repeatedly left in contact with the skin for a prolonged period. Although this is unlikely unless you handle used oil on a daily basis, it is still advisable to thoroughly wash your hands with soap and water as soon as possible after handling used oil.



Engine

Engine Tune-up	5-1
Timing Belt	5-7
Engine Removal/Installation	5-11
Exhaust System	5-23
Cooling	5-27

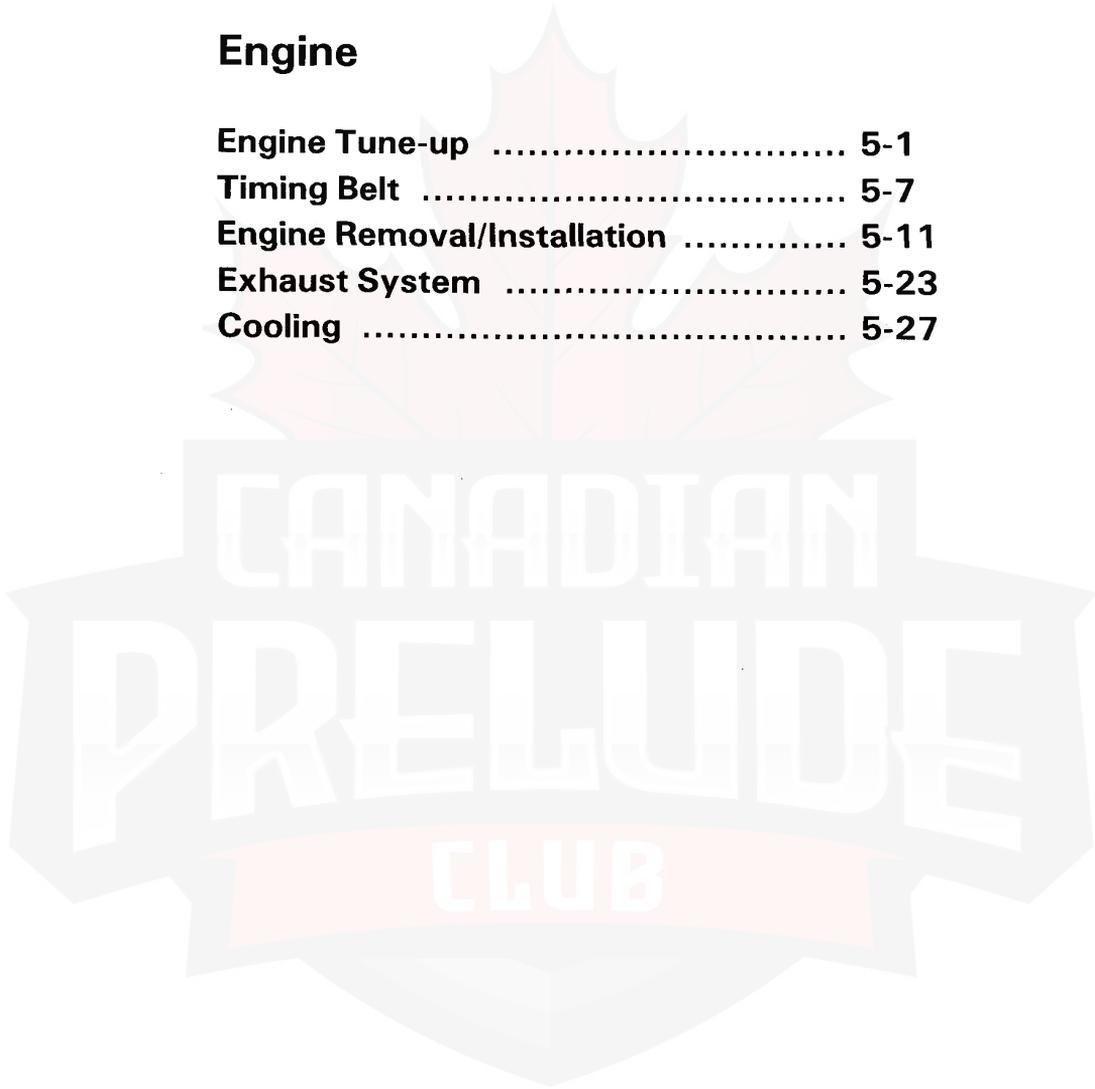

Engine Tune-up

Special Tools	5-2
Engine Oil Level Inspection	5-3
Engine Oil Replacement	5-3
Oil Filter Replacement	5-4
Valve Clearance Adjustment	5-6

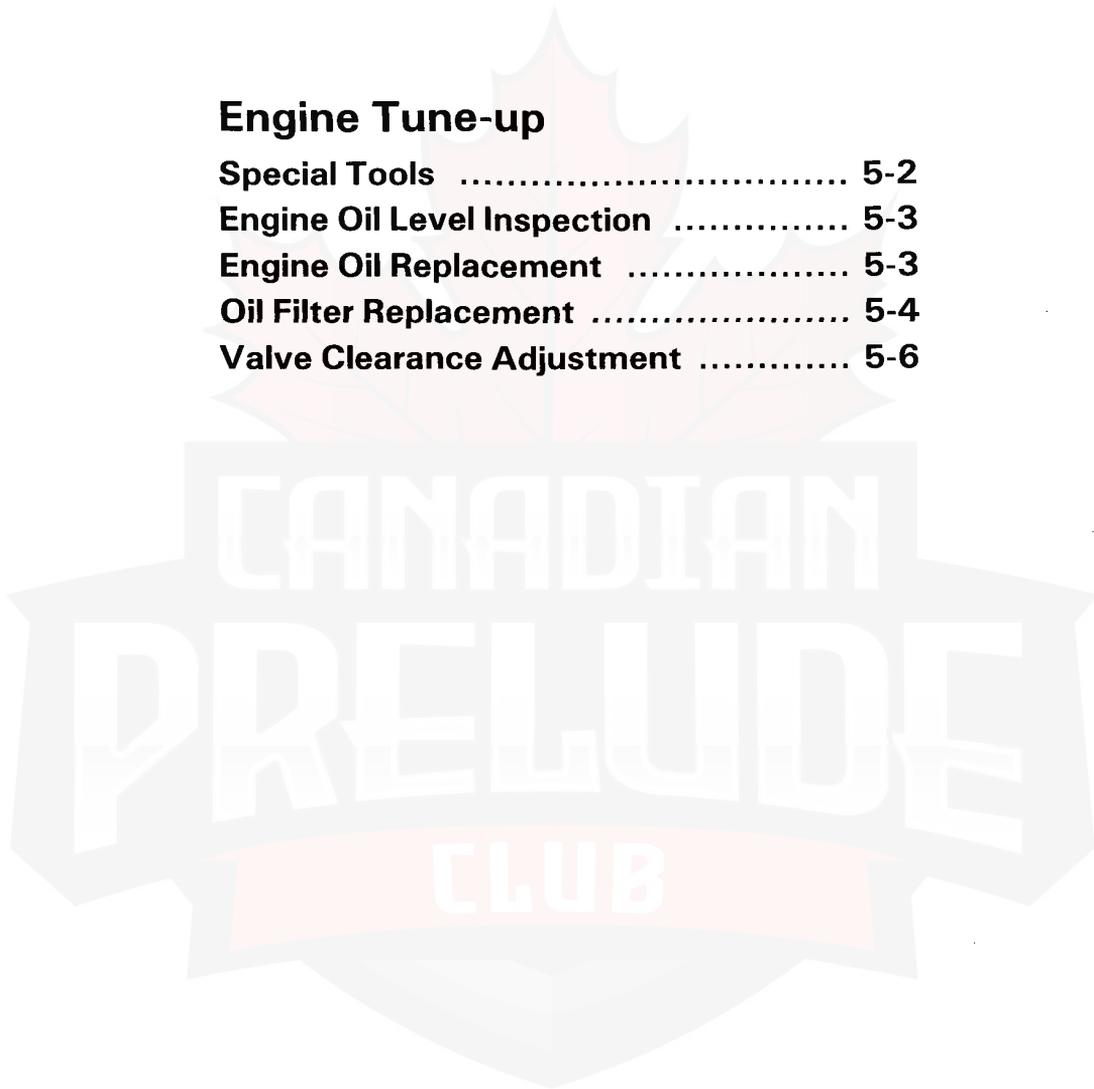

Outline of Model Changes

- The oil filter has been changed.
- The torque value of valve adjusting rock-nut has been changed.

Special Tools

Ref. No.	Tool Number	Description	Q'ty	Remarks
①	07912-6110001	Oil Filter Socket	1	

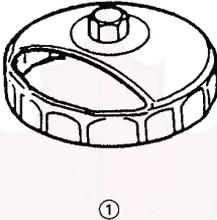

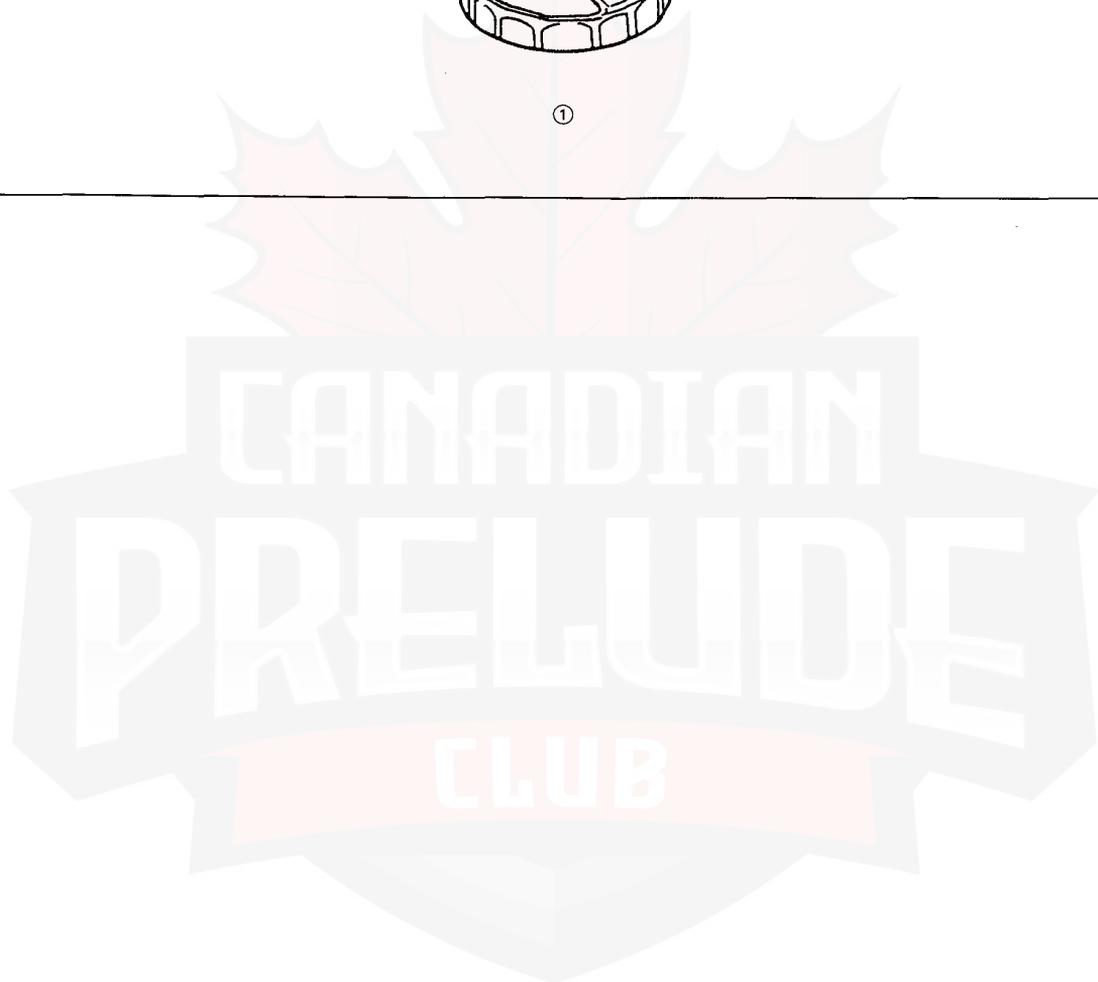



Engine Tune-up

Engine Oil Level Inspection

1. Check engine oil with the engine off and the car parked on level ground.
2. Make certain that the oil level indicated on the dipstick is between the upper and lower marks.
3. If the level has dropped close to the lower mark, add oil until it reaches the upper mark.

CAUTION: Insert the dipstick carefully to avoid bending it.

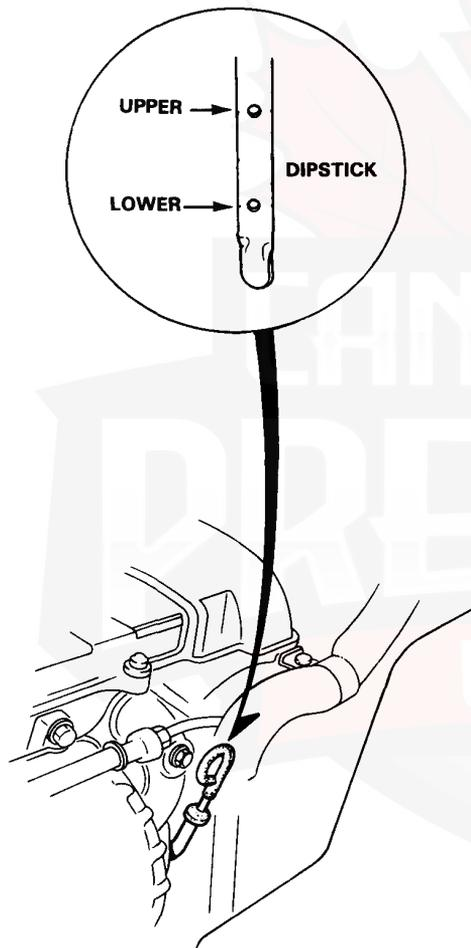

Engine Oil Replacement

1. Warm up the engine.
2. Drain the engine oil.

CAUTION: Used engine oil may cause skin cancer if repeatedly left in contact with the skin for prolonged periods. Although this is unlikely unless you handle used oil on a daily basis, it is still advisable to thoroughly wash your hands with soap and water as soon as possible after handling used oil.

NOTE: Remove the filler cap to speed draining.

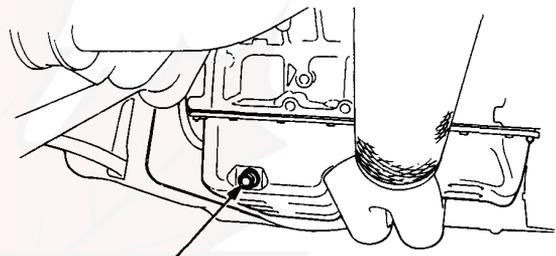

OIL PAN DRAIN PLUG
45 N-m (4.5 kg-m, 33 lb-ft)

3. Reinstall the drain plug with a new washer, and refill with the recommended oil.

Capacity	3.8 ℓ (4.0 US qt, 3.3 Imp qt) Adding replaced oil filter 4.7 ℓ (5.0 US qt, 4.1 Imp qt) Means designed value
Change	Every 10,000 km (6,000 miles) or 6 months.

NOTE: Oil filter should be replaced at each oil change.

Recommended Engine Oil (SE, SF or SG Grade)

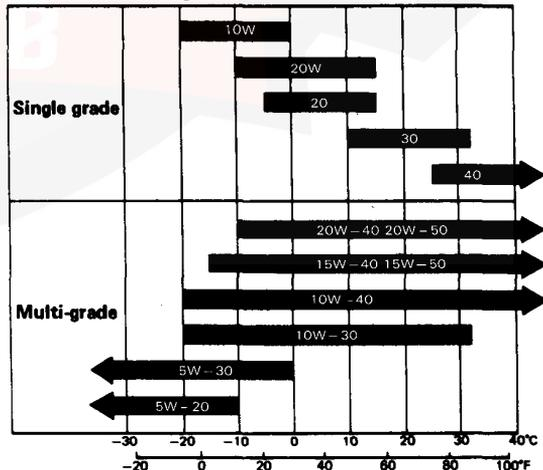

Expected Ambient Temperature before next oil change

Engine Tune-up

Oil Filter Replacement

CAUTION:

- After the engine has been run, the exhaust pipes will be hot; be careful when working around the exhaust manifold.
- Used engine oil may cause skin cancer if repeatedly left in contact with the skin for prolonged periods. Although this is unlikely unless you handle used oil on a daily basis, it is still advisable to thoroughly wash your hands with soap and water as soon as possible after handling used oil.

1. Remove the oil filter with the special oil filter socket.
2. Inspect the threads and rubber seal on the new filter. Wipe off seat on engine block, then apply a light coat of oil to the filter rubber seal.

NOTE: Use only filters with a built-in bypass system.

3. Install the oil filter by hand.
4. After the rubber seal is seated, tighten the oil filter clockwise with the special tool.

Tighten: 7/8 turn clockwise.

Tightening torque: 22 N·m (2.2 kg-m, 16 lb-ft)

CAUTION: Installation procedures other than the one above could result in serious engine defects due to oil leakage.

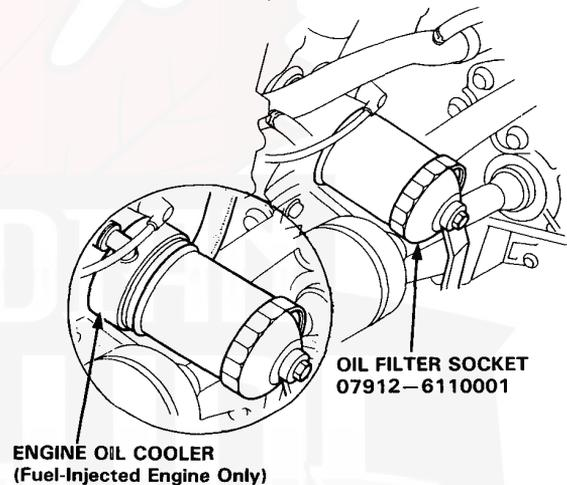
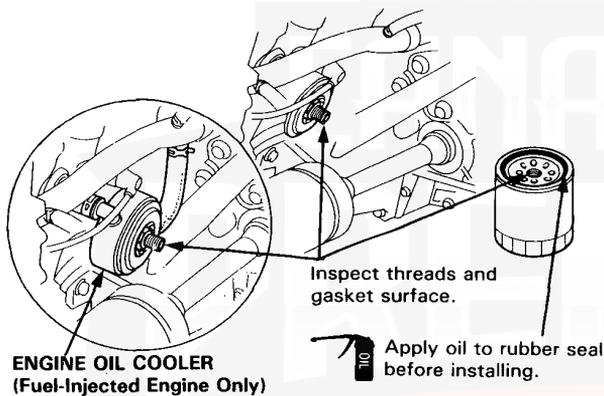

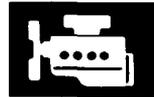

Eight numbers (1 to 8) are printed on the surface of the filter.

The following explains the procedure for tightening filters using these numbers.

- 1) Make a mark on the cylinder block under the number that shows at the bottom of the filter when the rubber seal is seated.
- 2) Tighten the filter by turning it clockwise seven numbers from the marked point. For example, if a mark is made under the number 2 when the rubber seal is seated, the filter should be tightened until the number 1 comes up to the marked point.

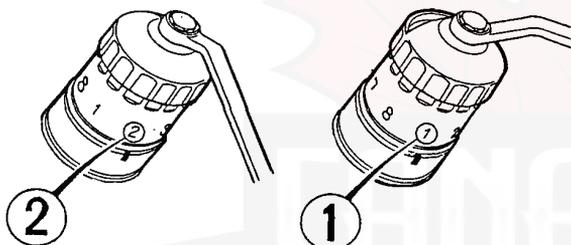

Number when rubber seal is seated.

Number after tightening.

Number when rubber seal is seated	1	2	3	4	5	6	7	8
Number after tightening	8	1	2	3	4	5	6	7

5. After installation, fill the engine with oil up to the specified level, run the engine for more than 3 minutes, then check for oil leakage.

Engine Tune-up

Valve Clearance Adjustment

Fuel-Injected Engine:

NOTE:

- Valves should be adjusted cold when the cylinder head temperature is less than 38°C (110°F). Adjustment is the same for intake and exhaust valves.
- If pulley bolt broke loose while turning crank, retorque it to 150 N·m (15.0 kg-m, 108 lb-ft).

1. Remove the valve cover.

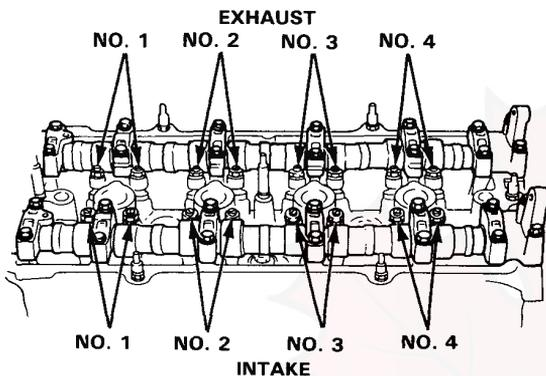

2. Set the No. 1 piston at TDC. "UP" marks in the pulleys should be at top, and the TDC grooves on back side of pulley should align with cylinder head surface. The distributor rotor must be pointing towards No. 1 plug wire.

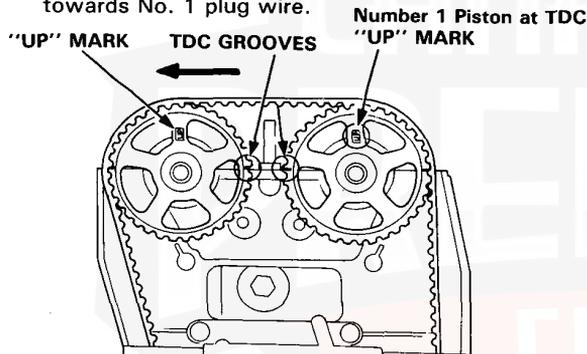

3. Adjust valves on No. 1 cylinder.
Intake: 0.08–0.12 mm (0.003–0.005 in.)
Exhaust: 0.16–0.20 mm (0.006–0.008 in.)

4. Loosen locknut and turn the adjusting screw until the feeler gauge slides back and forth with a slight amount of drag.

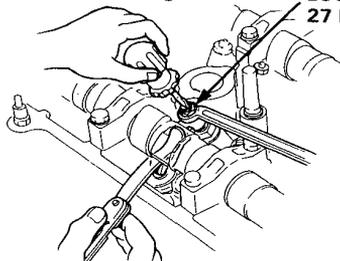

LOCKNUT 7 x 0.75 mm
27 N·m (2.7 kg-m, 20 lb-ft)

5. Tighten locknut and check clearance again. Repeat adjustment if necessary.
6. Rotate crankshaft 180° counterclockwise (cam pulley turns 90°). The "UP" marks should be at exhaust side. Distributor rotor should point to No. 3 plug wire. Adjust valves on No. 3 cylinder.

Number 3 piston at TDC

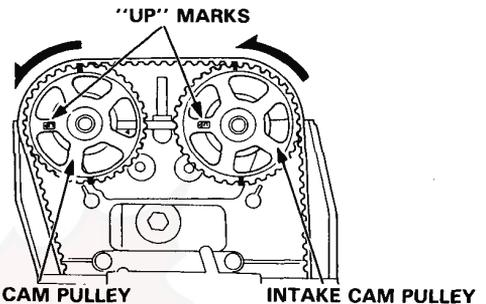

7. Rotate crankshaft 180° counterclockwise to bring No. 4 piston to TDC. Both "UP" marks should be at bottom and the distributor rotor should point to the No. 4 plug wire. Adjust valves on No. 4 cylinder.

Number 4 piston at TDC

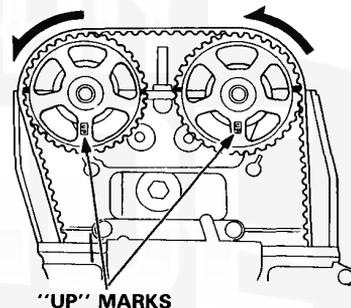

8. Rotate crankshaft 180° counterclockwise to bring No. 2 piston to TDC. "UP" marks should be at intake side. Distributor rotor should point to No. 2 plug wire. Adjust valves on No. 2 cylinder.

Number 2 piston at TDC

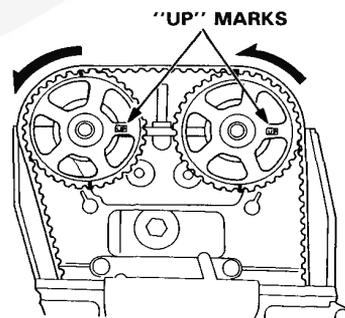

Timing Belt

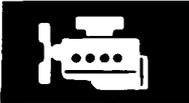

Outline of Model Change

The service interval for the timing belt has been added.

Special Tools

Ref. No.	Tool Number	Description	Q'ty	Remarks
①	07JAB-0010000	Crank Pulley Holder Set	1	Crankshaft pulley
①-1	07JAA-0010200	Socket Wrench, 19 mm	1	} Component tools
①-2	07JAB-0010100	Pulley Holder Attachment	1	
①-3	07JAB-0010200	Handle	1	

①-1 ①-2 ①-3



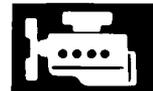

Timing Belt

Illustrated Index

NOTE:

- Before removing, mark direction of rotation.
- Refer to base manual to position the crankshaft and timing belt pulleys before installing timing belt.

Fuel-Injected Engine:

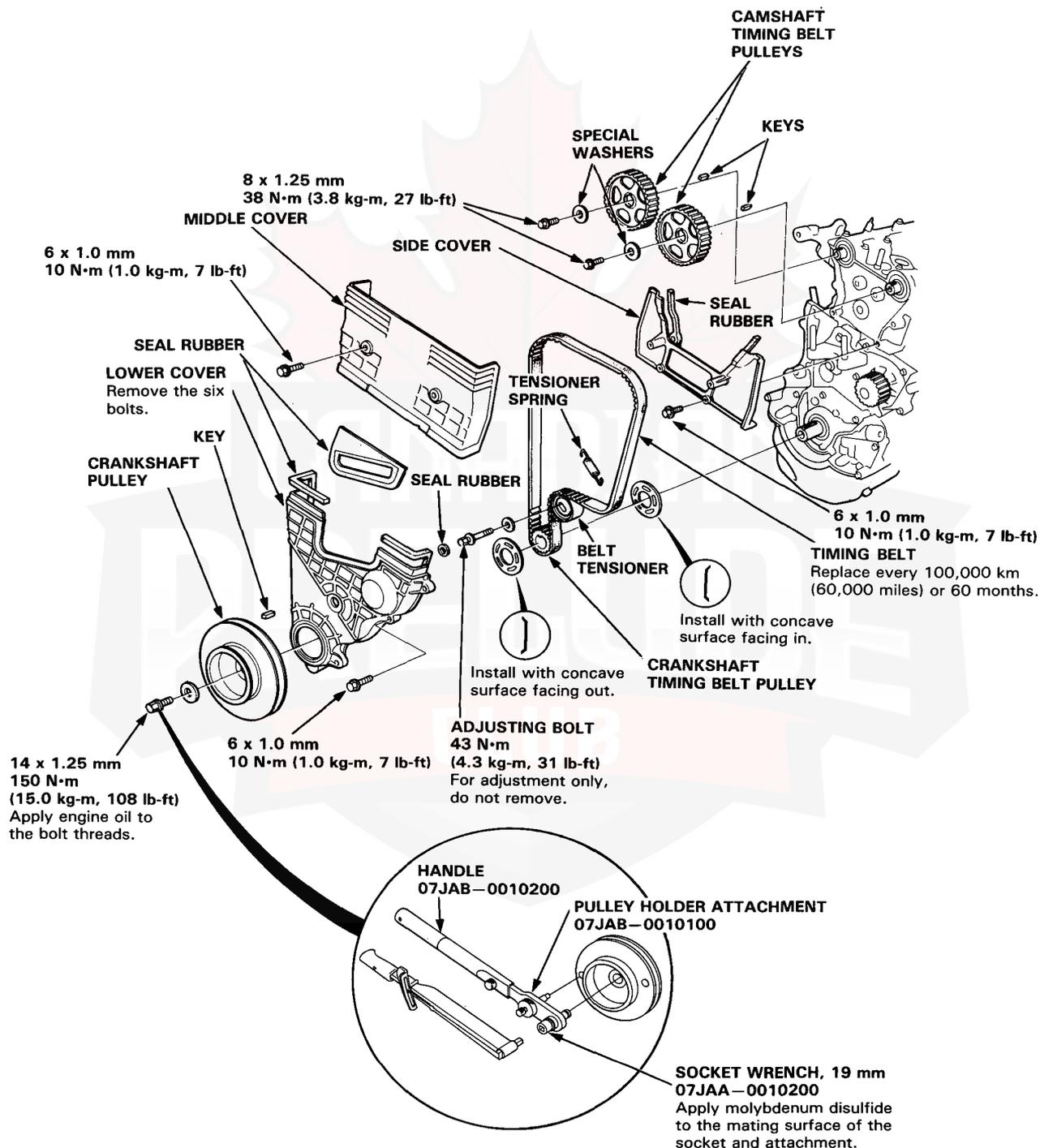

Timing Belt

Illustrated Index

NOTE:

- Before removing, mark direction of rotation.
- Refer to base manual to position the crankshaft and timing belt pulleys before installing timing belt.

Carbureted Engine:

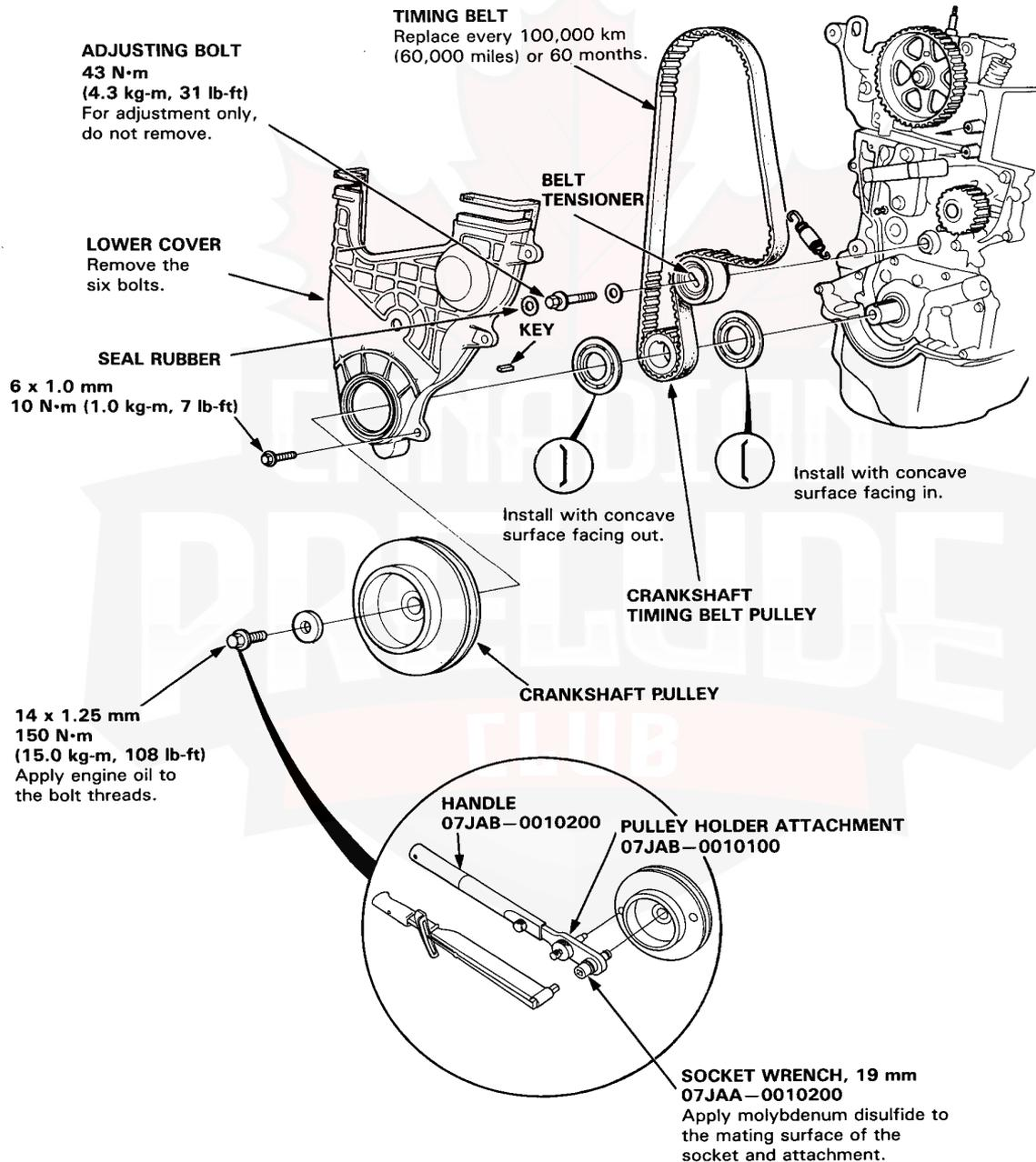

Engine Removal/Installation

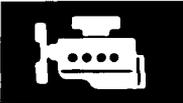

Outline of Model Changes

- The air intake hose of fuel-injected engine has been changed.
- The torque value of mounting bolts for front beam, rear beam and center beam have been added.

Engine Removal/Installation

⚠ WARNING

- Make sure jacks and safety stands are placed properly (pages 1-6 thru 8), and hoist brackets are attached to correct positions on the engine (page 5-18).
- Apply parking brake and block rear wheels, so car will not roll off stands and fall on you while working under it.

CAUTION: Use fender covers to avoid damaging painted surfaces.

⚠ WARNING Use care when removing radiator cap and when draining radiator, engine and transmission, to avoid scalding by hot coolant or oil.

1. Disconnect the battery negative terminal first, then the positive terminal.
2. Unbolt the hood brackets and remove the hood after removing the washer hose.

CAUTION: Use care when storing the hood to avoid damaging the paint.

3. Remove the drain plug to drain engine oil.
 - Remove the filler cap to speed draining.

CAUTION: After draining the engine oil, always replace drain washers with new ones.

Carbureted Engine:

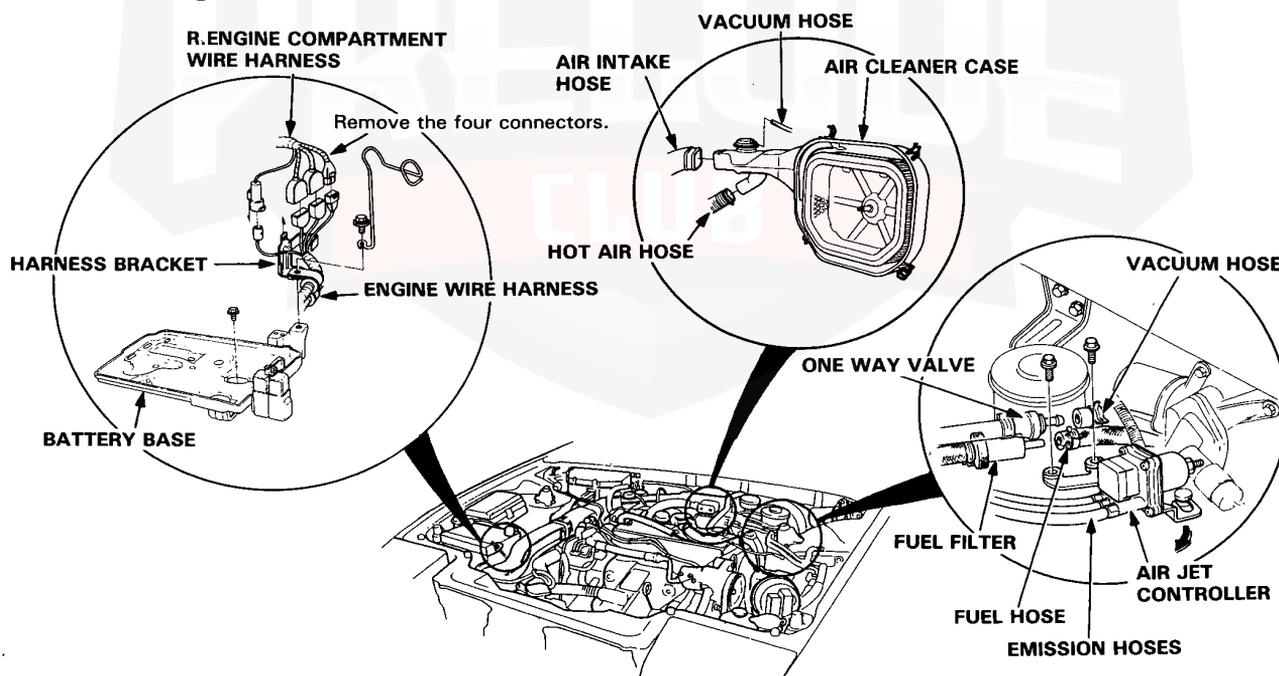

4. Drain transmission oil.
 - Use a 3/8" drive socket wrench to remove the drain plug.
 - Remove the level gauge or filler bolt to speed draining.
5. Loosen the drain plug to drain coolant from the radiator.
 - Remove the radiator cap to speed draining.

Carbureted Engine (Fuel-Injected Engine, go to step 11.)

6. Remove the battery and battery base.
7. Remove the air intake hose and air cleaner case.
8. Disconnect the fuel hose at the fuel filter.

⚠ WARNING Do not smoke while working on fuel system, keep open flame or spark away from work area. Drain fuel only into an approved container.

9. Disconnect the brake booster vacuum hose at the one way valve.
10. Remove the air jet controller.
 - Do not disconnect the emission hoses.



Fuel-Injected Engine (Carbureted Engine, go to step 16)

11. Remove the battery and the battery base.
12. Remove the air intake hose air cleaner and front resonator chamber as an assembly.
13. Remove the battery wires from the relay box.
14. Relieve fuel pressure.

⚠ WARNING Do not smoke while working on fuel system, keep open flame or spark away from work area. Drain fuel only into an approved container.

15. Disconnect the fuel feed hose and fuel return hose.

Fuel-Injected Engine:

16. Disconnect the charcoal canister vacuum hose at the throttle valve.
17. Disconnect the throttle cable at the throttle body or carburetor.

NOTE: Take care not to bend the cable when removing it. Do not use pliers to remove the cable from the linkage. Always replace a kinked cable with a new one.

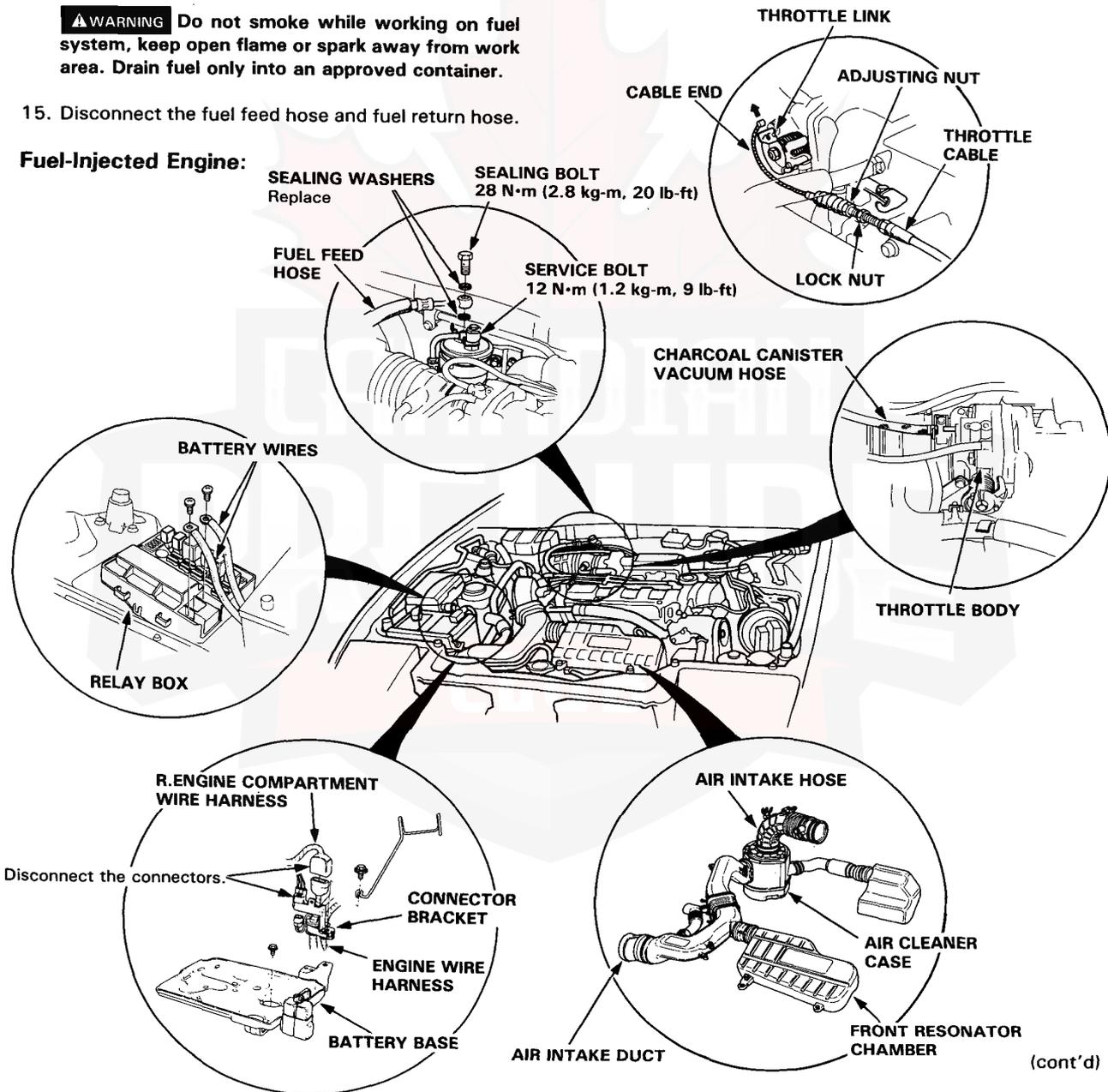

(cont'd)

Engine Removal/Installation

(cont'd)

18. Disconnect the ignition coil wire, radio noise condenser ground wire and ignition primary connector (Carbureted Engine only), then remove the distributor.
19. Disconnect the upper and lower radiator hoses.
20. Disconnect the inlet and outlet heater hoses.
21. Disconnect the automatic transmission fluid (ATF) cooler hoses (A/T).
 - Plug the ATF cooler hoses.
22. Disconnect the vacuum hose, then remove the cruise control actuator (with cruise control).

Fuel-Injected Engine shown; Carbureted Engine similar:

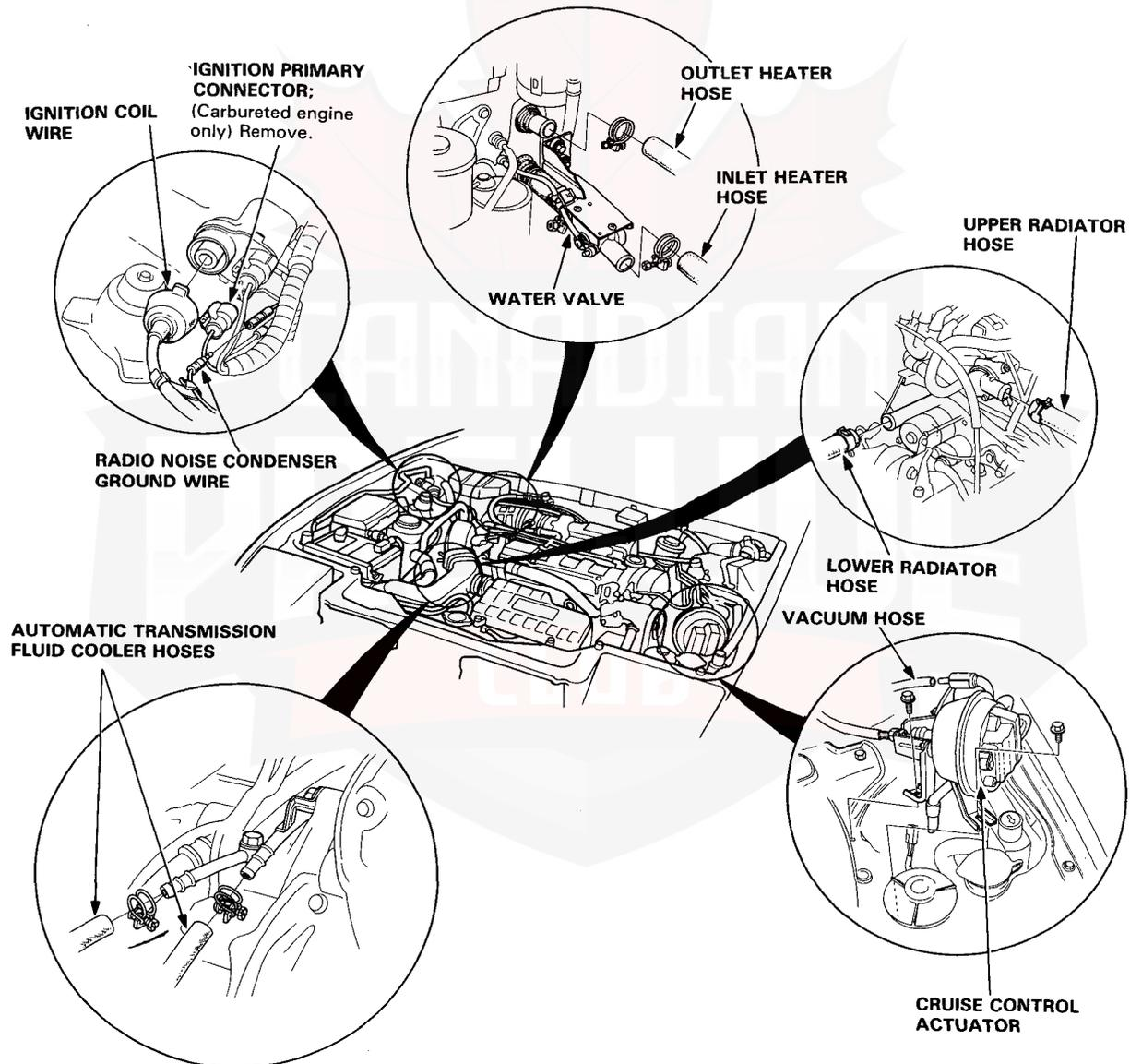



23. Disconnect the engine wire harness connectors from R. engine compartment wire harness (Fuel-Injected Engine only).

Fuel-Injected Engine:

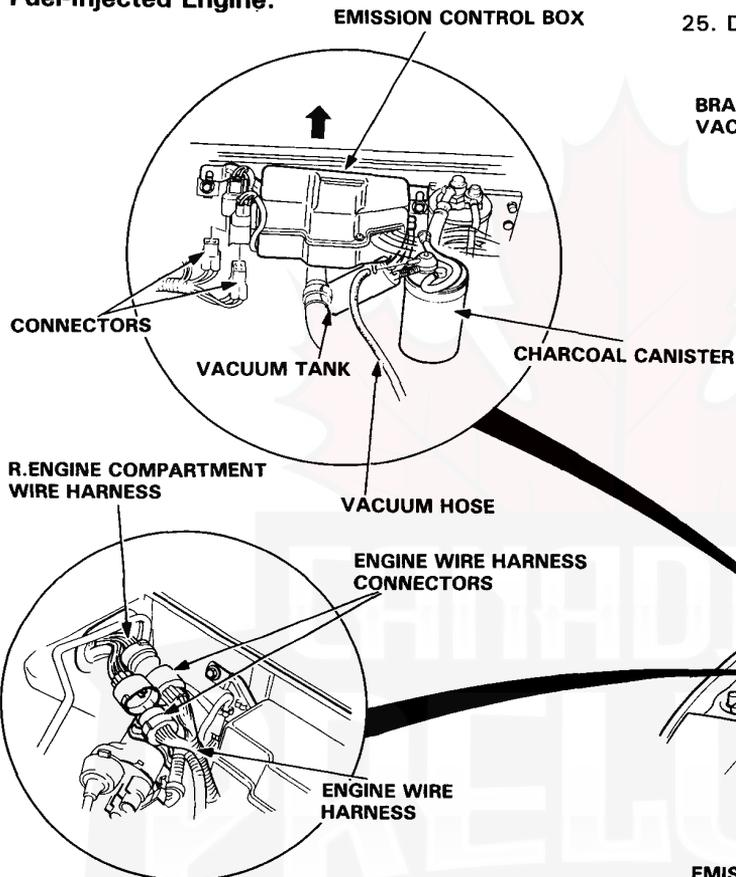

24. Disconnect the two connectors, then remove the emission control box and vacuum tank.

- Don't disconnect the vacuum hoses.

25. Disconnect the brake booster vacuum hose.

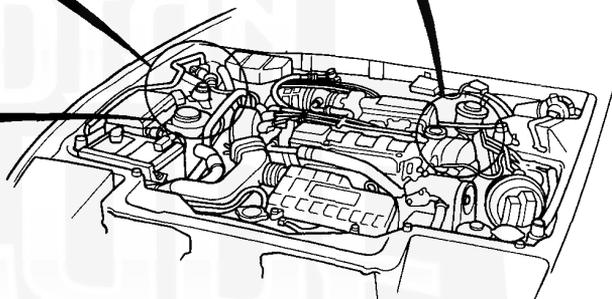
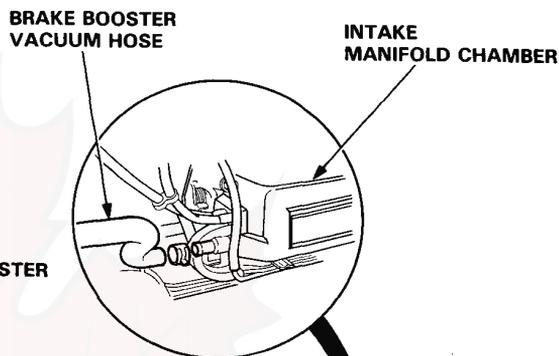

Carbureted Engine:

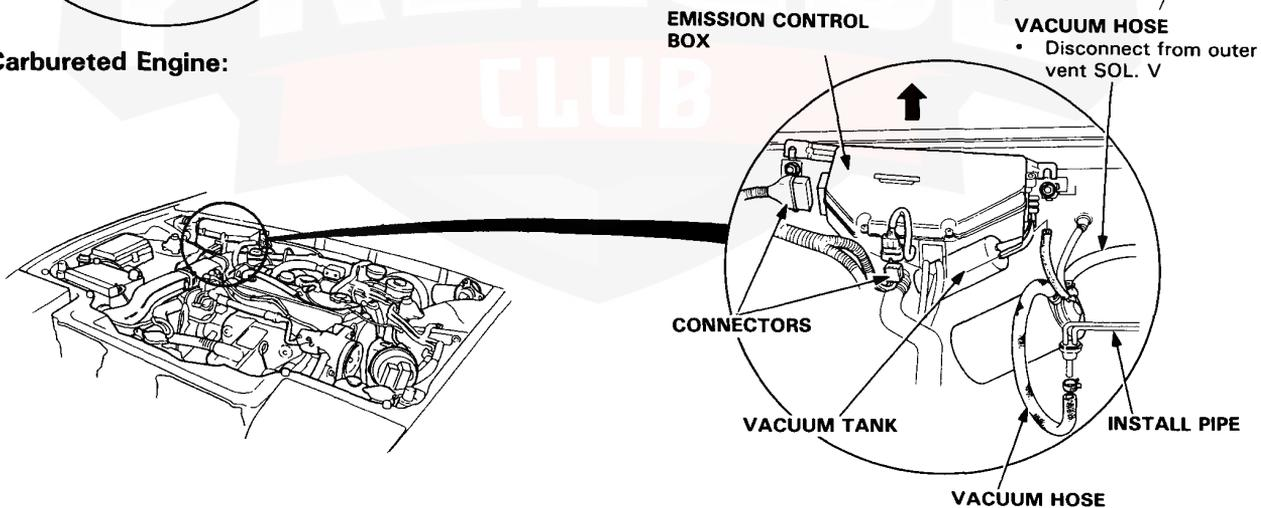

(cont'd)

Engine Removal/Installation

(cont'd)

26. Remove the power steering (P/S) pump belt and alternator belt (6-21).

27. Disconnect the inlet hose and remove the power steering pump.

CAUTION: When the hose is disconnected, fluid will flow out. Cover the alternator with a shop towel.

28. Remove the alternator.

29. Remove the condenser fan shroud.

30. Remove the air conditioning (A/C) compressor, then mount compressor on the front beam.

- Do not disconnect the A/C hoses.

Fuel-Injected Engine shown; Carbureted Engine similar:

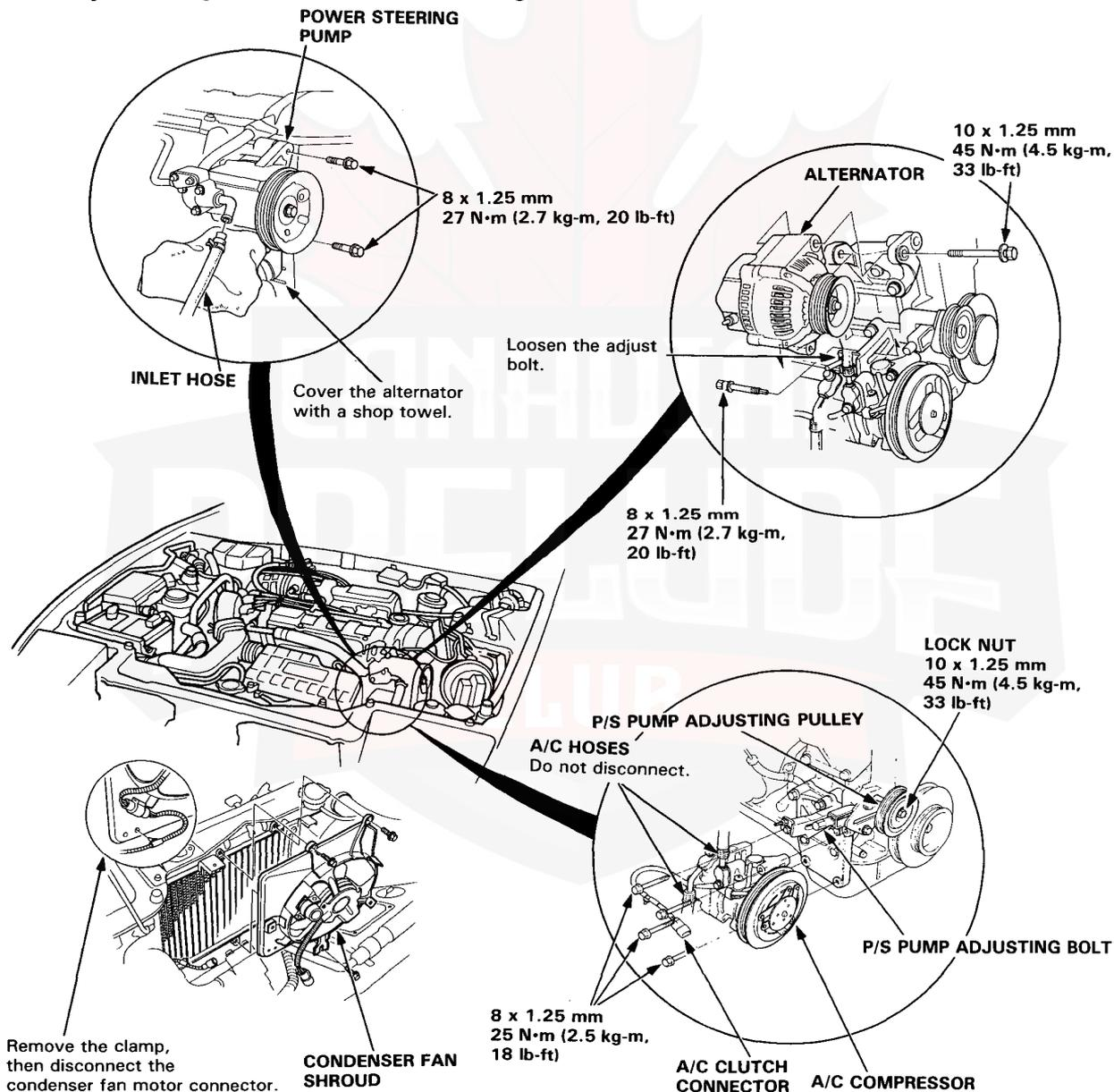



31. Disconnect the shift cable and select cable from the transmission, then remove the cable bracket (M/T).
32. Remove the automatic transmission shift cable from the transmission (A/T).

NOTE:

- Take care not to bend the cable when removing it. Do not use pliers to remove the cable. Always replace a kinked cable with a new one.
- On reassembly, check the cable adjustment (See Section 13 for M/T and Section 14 for A/T of base manual).

33. Remove the transmission ground wire.
34. Remove left axle and half shaft.

35. Remove clutch slave cylinder.

NOTE: Do not disconnect hose from the slave cylinder.

36. Remove the speed sensor and the connector.

NOTE:

- Remove the oxygen sensor prior to disconnecting the exhaust pipe A and the exhaust manifold.
- Do not use the impact wrench or hammer when the oxygen sensor is not to be removed.
- Reinstallation of oxygen sensor should be carried out after connecting the exhaust pipe A and the exhaust manifold.
- Do not tighten the connection with the impact wrench if the oxygen sensor has not been removed.

Fuel-Injected Engine shown; Carbureted Engine similar:

M/T

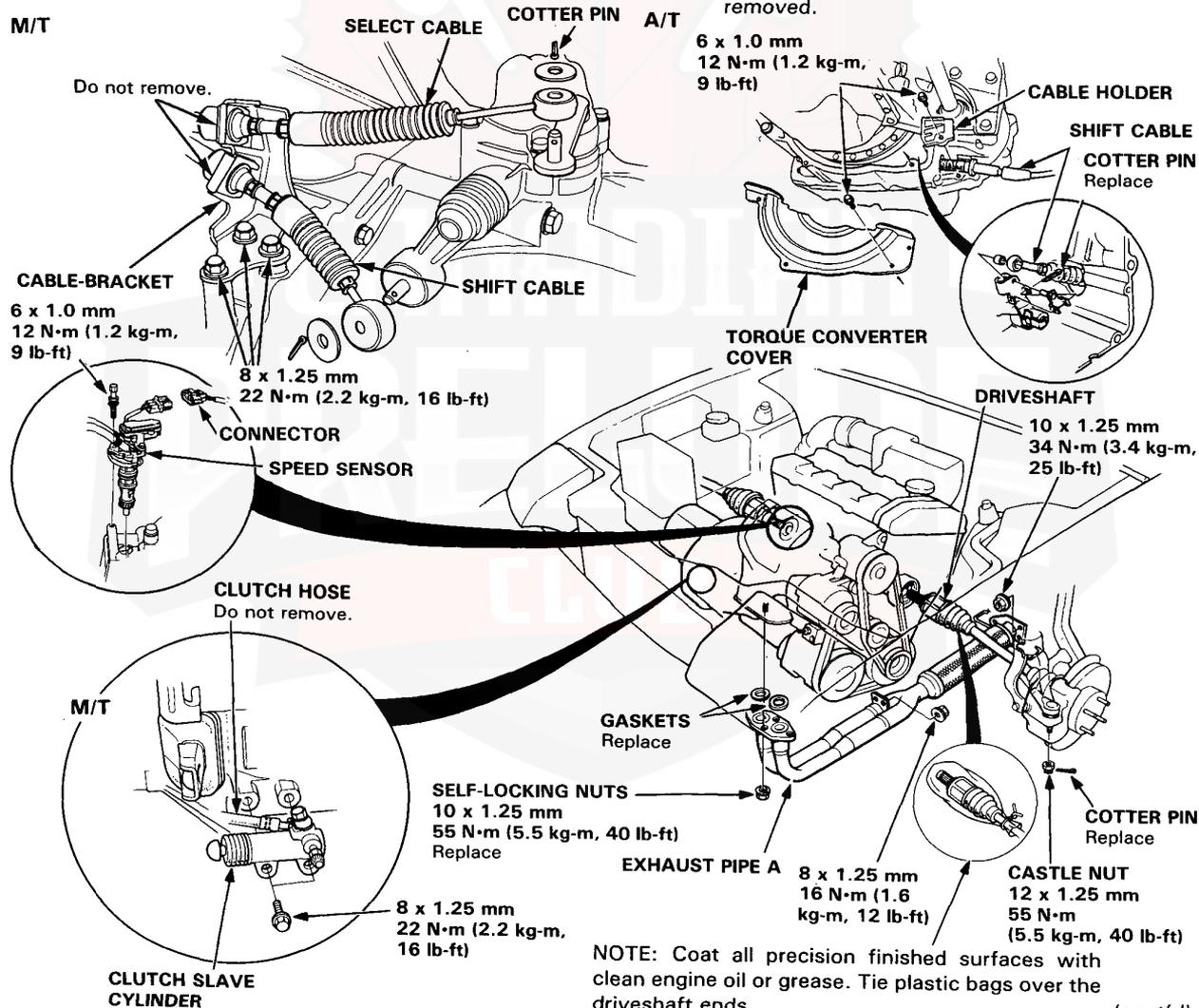

(cont'd)

Engine Removal/Installation

(cont'd)

37. Attach a chain hoist to the engine block and raise the hoist just enough to remove slack from chain.
38. Remove the rear engine mount bolt, then remove the mount bracket.
39. Remove the front engine mount bolt.

NOTE: Front and rear engine mount bolts are special bolts. Replace the bolts once they are loosened.

40. Remove the side engine mount bracket bolts.
41. Remove the transmission mount bolt.

42. Check that wires and tubes are completely removed from the engine, and lift the engine slowly with the chain.
43. Tilt the engine, then hoist it out of the engine compartment.

CAUTION: Use care to avoid damaging the body.

⚠ WARNING Do not crawl under the car when hoisting the engine.

Fuel-Injected Engine shown; Carbureted Engine similar:

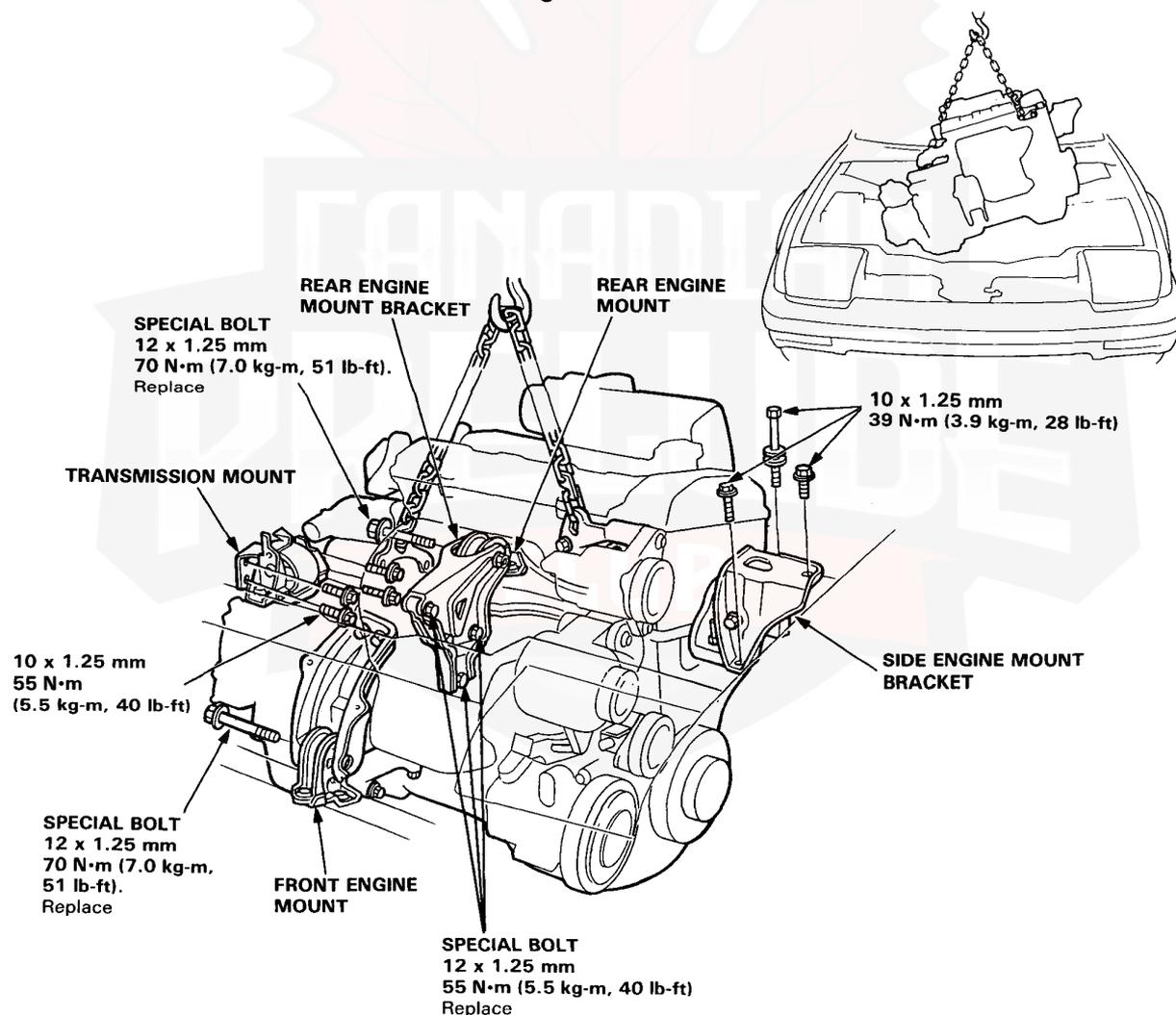



NOTE: For proper suppression of noise and vibration, and maximum bushing life, tighten the bolts in the sequence shown with the bushings centered in their mounts.

Fuel-Injected Engine shown; Carbureted Engine similar:

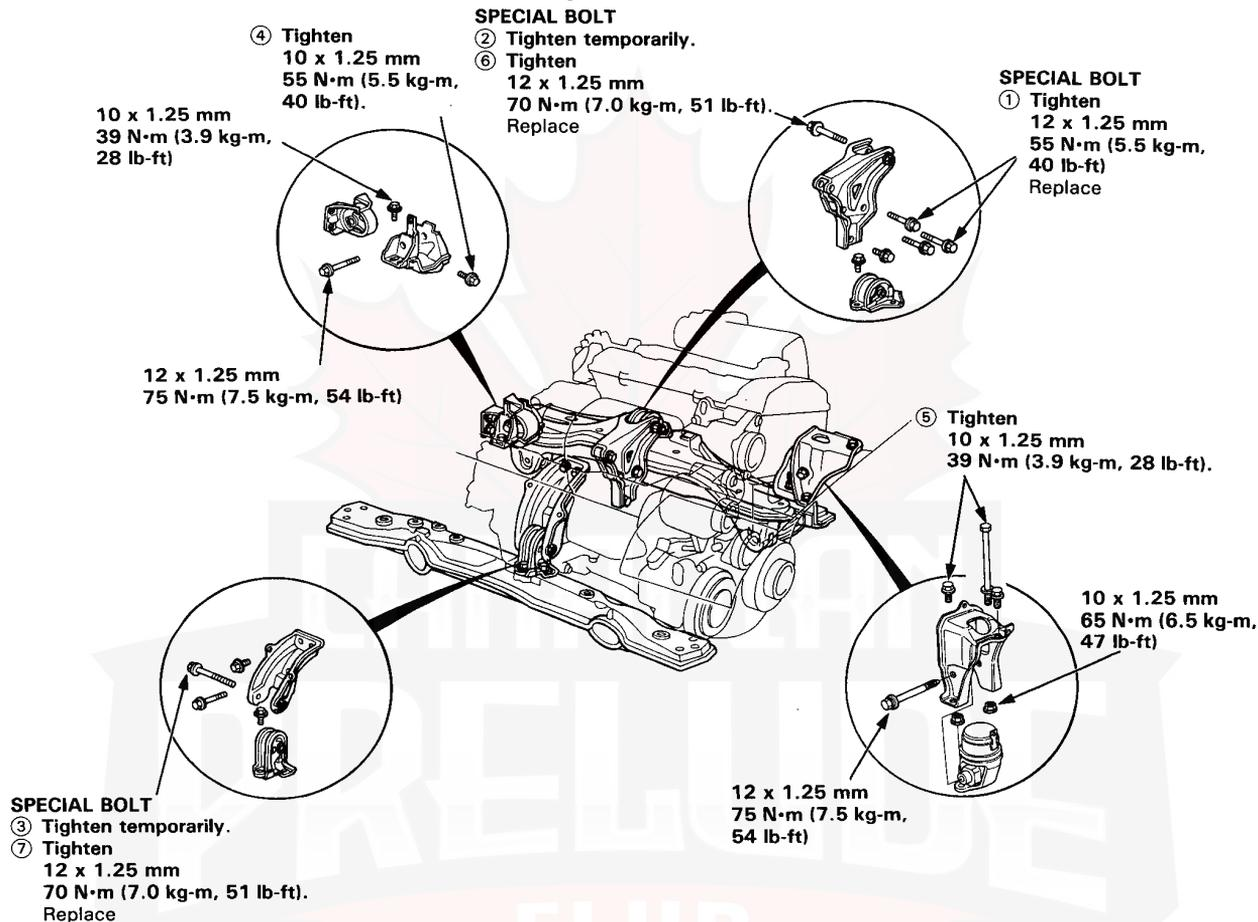

44. Install the engine in the reverse order of removal. After the engine is in place:

- Torque engine mount bolts in sequence shown.

CAUTION: Failure to tighten the bolts in the proper sequence can cause excessive noise and vibration, and reduce bushing life; check that the bushings are not twisted or offset.

- Check that the spring clip on the end of each driveshaft clicks into the differential.

CAUTION: Use new spring clips on installation.

- Bleed air from the cooling system at the bleed bolt with the heater valve open.

- Adjust the throttle cable tension.
- Adjust the alternator belt and power steering pump belt tension.
- Check the clutch pedal free play.
- Check that the transmission shifts into gear smoothly.
- Install the A/C compressor, connect the wiring and V-belt.
- Clean battery posts and cable terminals with sandpaper, assemble, then apply grease to prevent corrosion.

(cont'd)

Engine Removal/Installation

(cont'd)

NOTE: For proper suppression of noise and vibration, and maximum bushing life, tighten the bolts to the torque mentioned below.

Fuel-Injected Engine Shown; Carbureted Engine similar:

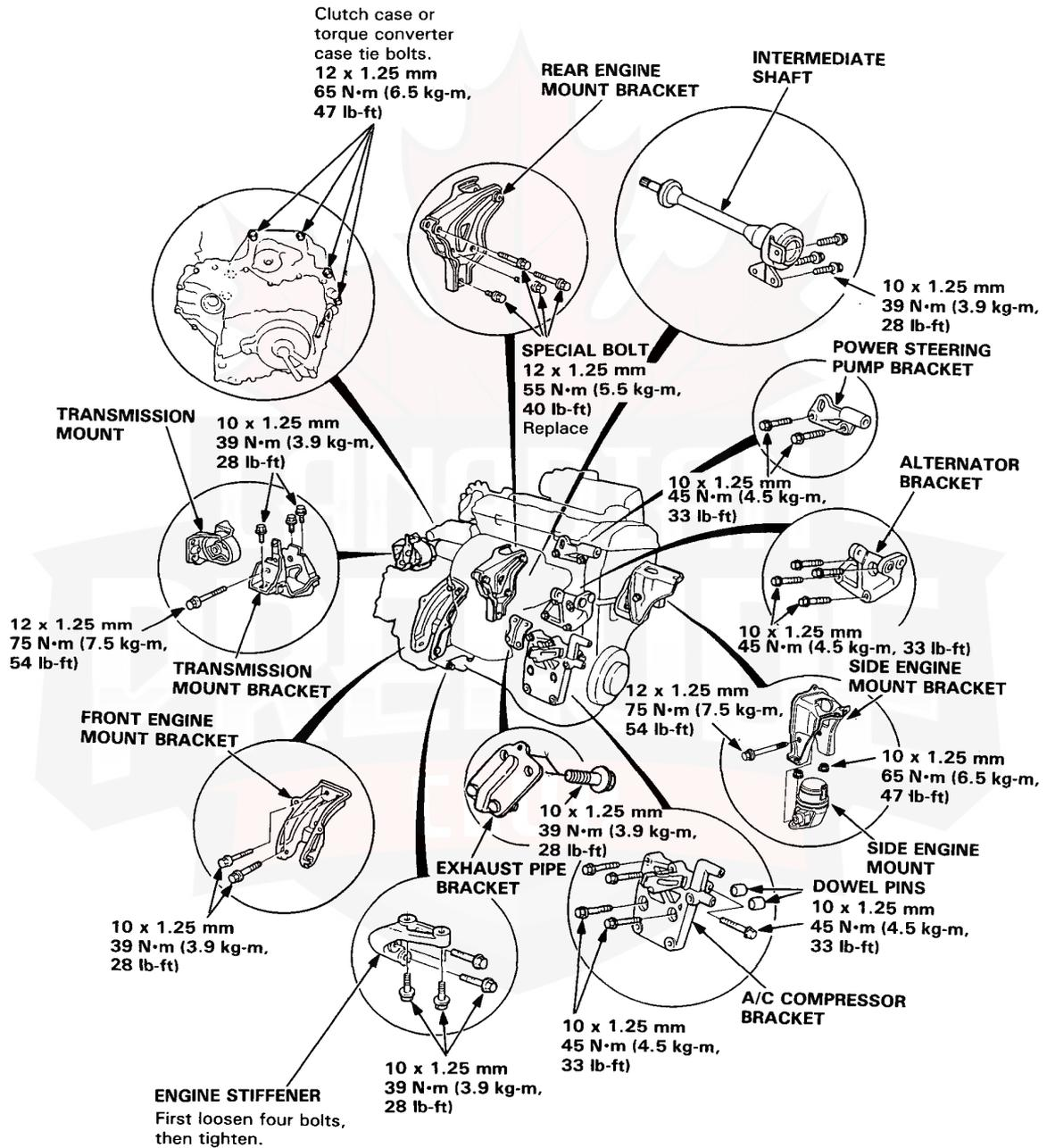



Subframe Torque Value Specifications:

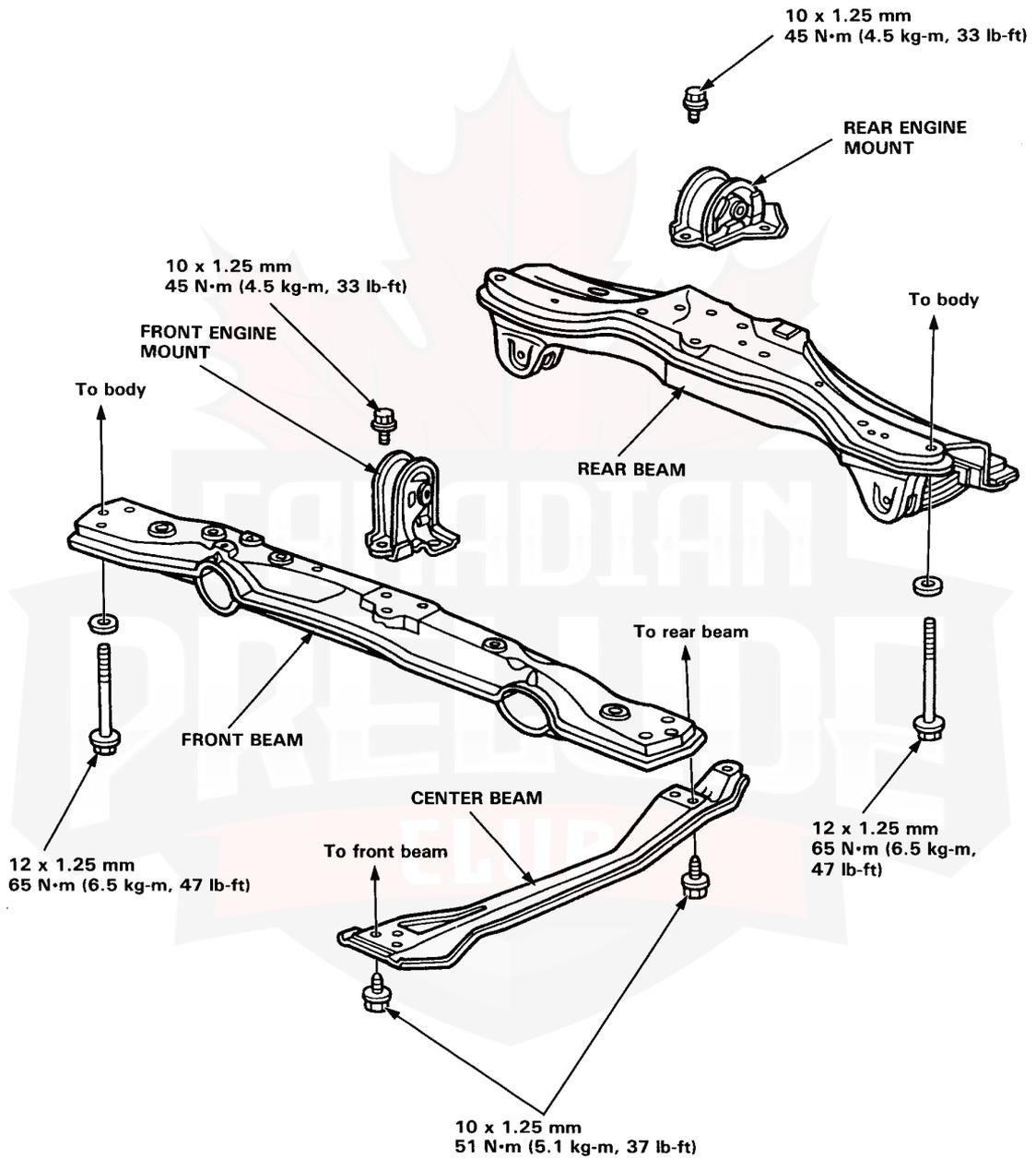

Exhaust System

Exhaust Manifold	5-24
Exhaust Pipe and Muffler	5-26

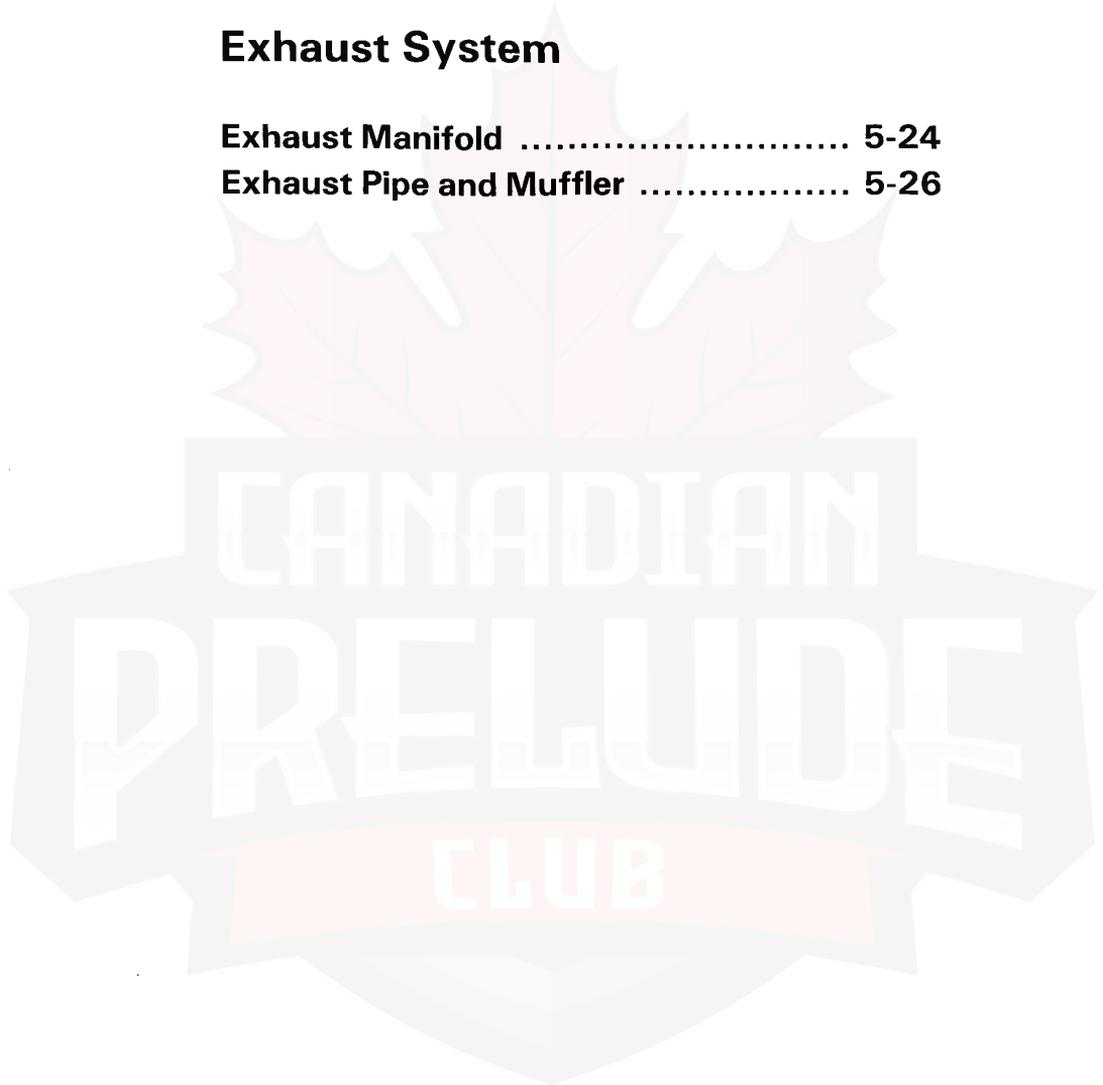
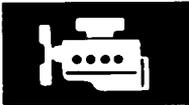

Outline of Model Changes

- The exhaust manifold for fuel-injected engine (except KG, KS, KX) has been modified.
- The exhaust manifold for fuel-injected engine (KG, KS, KX) has been changed.
- The exhaust pipe A has been modified.

Exhaust Manifold

Illustrated Index

Fuel-Injected Engine (except KG, KS, KX):

NOTE:

- Remove the oxygen sensor prior to disconnecting the exhaust pipe A and the exhaust manifold.
- Do not use the impact wrench or hammer when the oxygen sensor is not to be removed.
- Reinstallation of oxygen sensor should be carried out after connecting the exhaust pipe A and the exhaust manifold.
- Do not tighten the connection with the impact wrench if the oxygen sensor has not been removed.

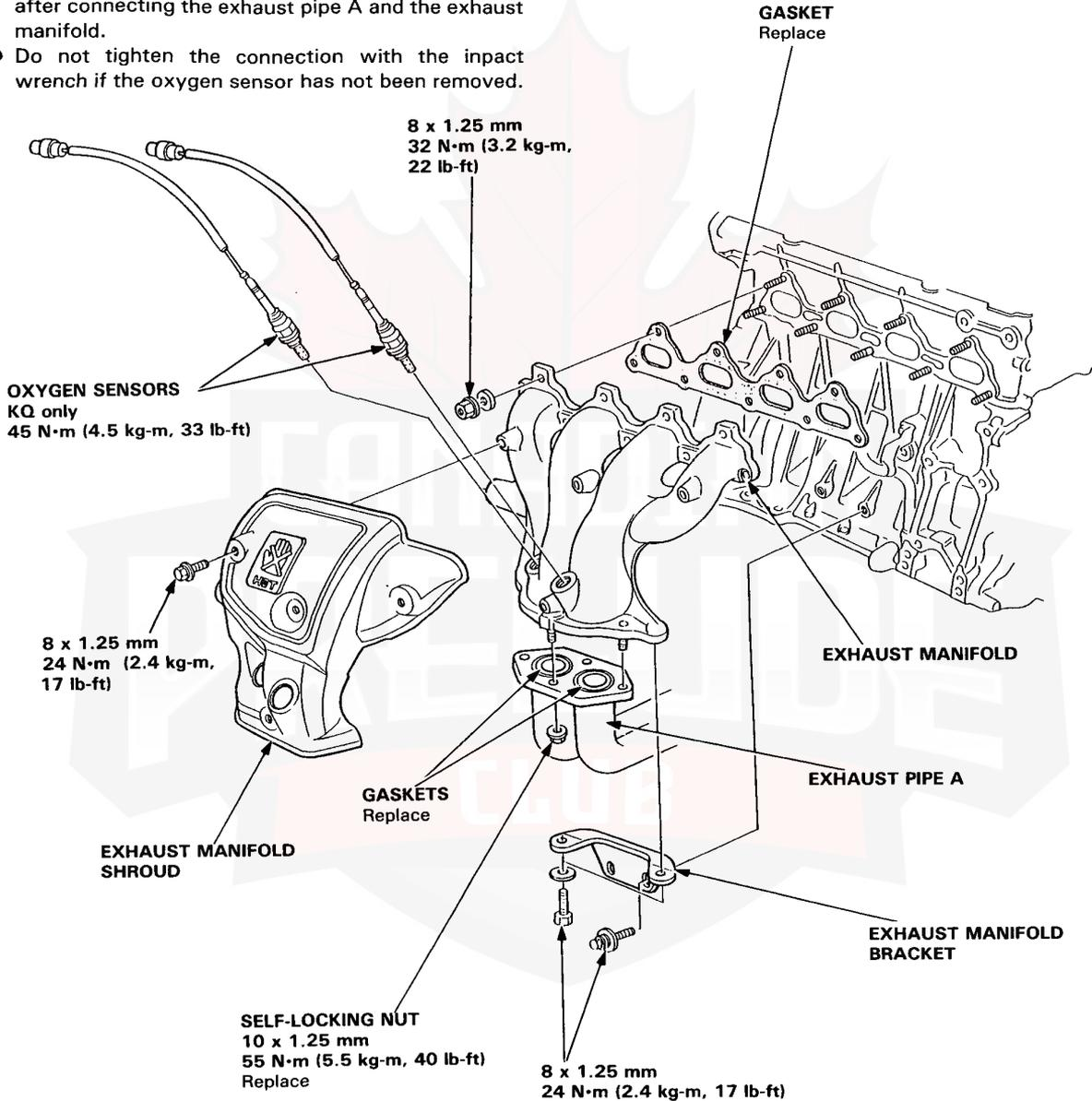



Fuel-Injected Engine (KG, KS, KX):

NOTE:

- Remove the oxygen sensor prior to disconnecting the exhaust pipe A and the exhaust manifold.
- Do not use the impact wrench or hammer when the oxygen sensor is not to be removed.
- Reinstallation of oxygen sensor should be carried out after connecting the exhaust pipe A and the exhaust manifold.
- Do not tighten the connection with the impact wrench if the oxygen sensor has not been removed.

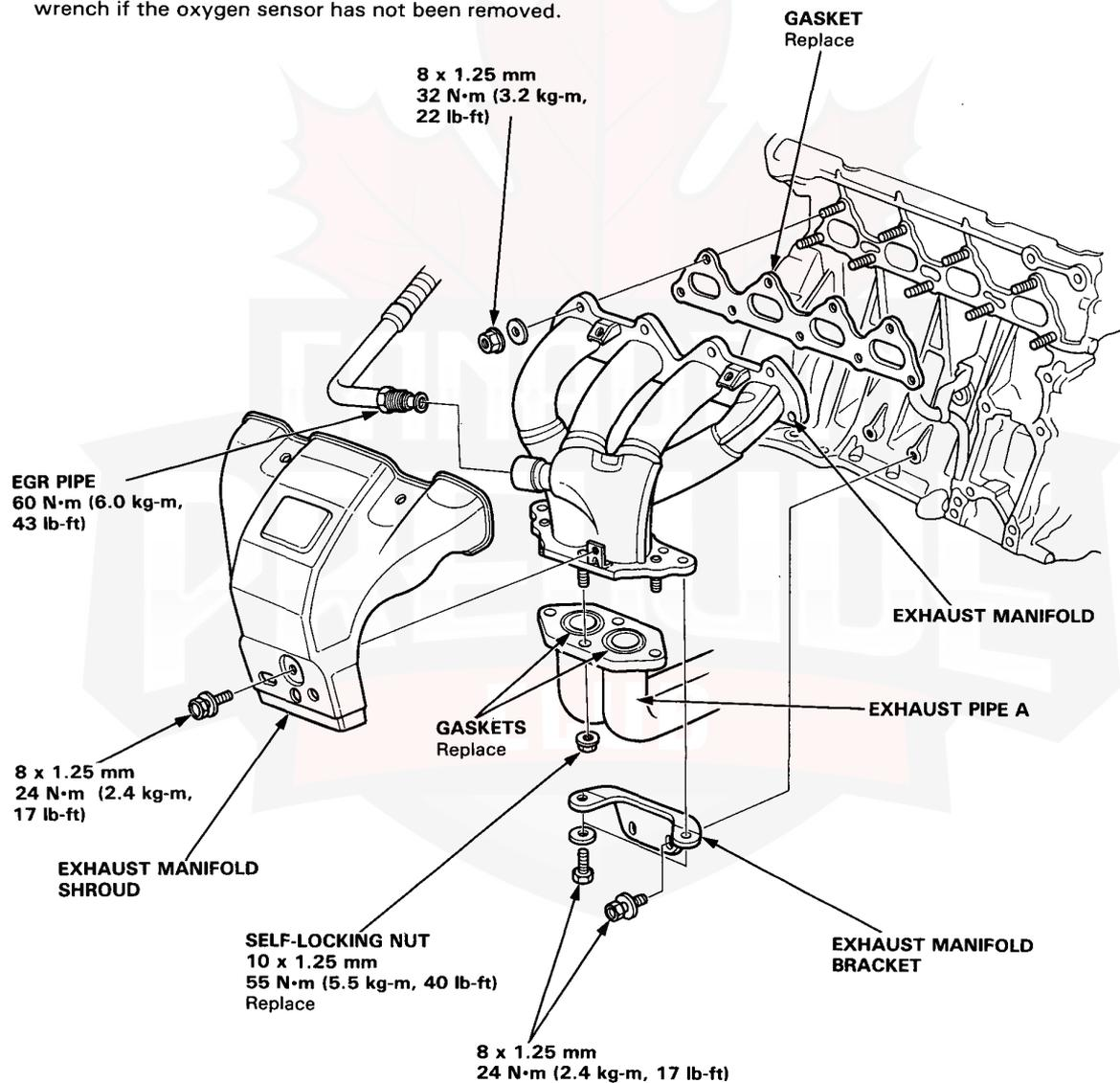

Exhaust Pipe and Muffler

Replacement

NOTE:

- Remove the oxygen sensor prior to disconnecting the exhaust pipe A and the exhaust manifold.
- Do not use the impact wrench or hammer when the oxygen sensor is not to be removed.
- Reinstallation of oxygen sensor should be carried out after connecting the exhaust pipe A and the exhaust manifold.
- Do not tighten the connection with the impact wrench if the oxygen sensor has not been removed.

Fuel-Injected Engine:

FUEL TANK HEAT SHIELD

Carbureted Engine:

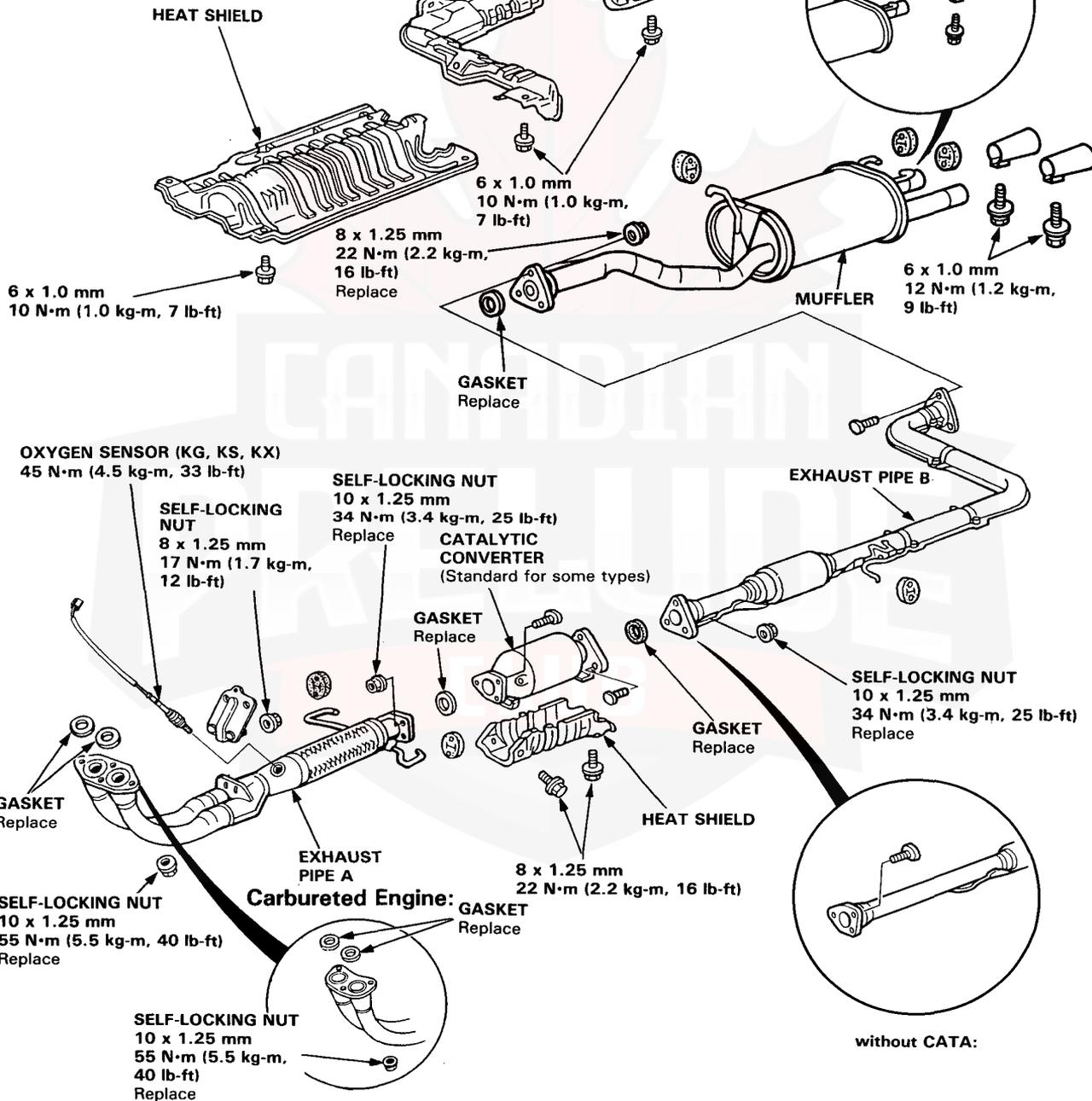

Cooling

Water pump 5-28



Outline of Model Changes

- The inspection of water pump has been added.

Water pump

Inspection

1. Remove the timing belt.
2. Check that the water pump pulley turns freely.
3. Check the signs of seal leakage.

NOTE: A small amount of "weeping" from the bleed hole is normal.

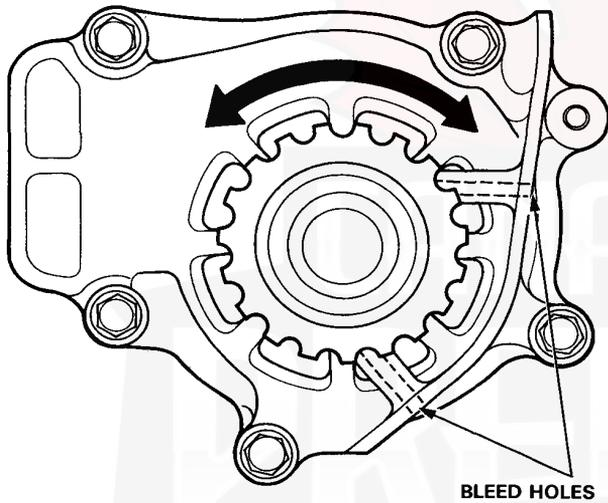

Fuel and Emissions

Carbureted Engine	6-1
Fuel-Injected Engine	6-103

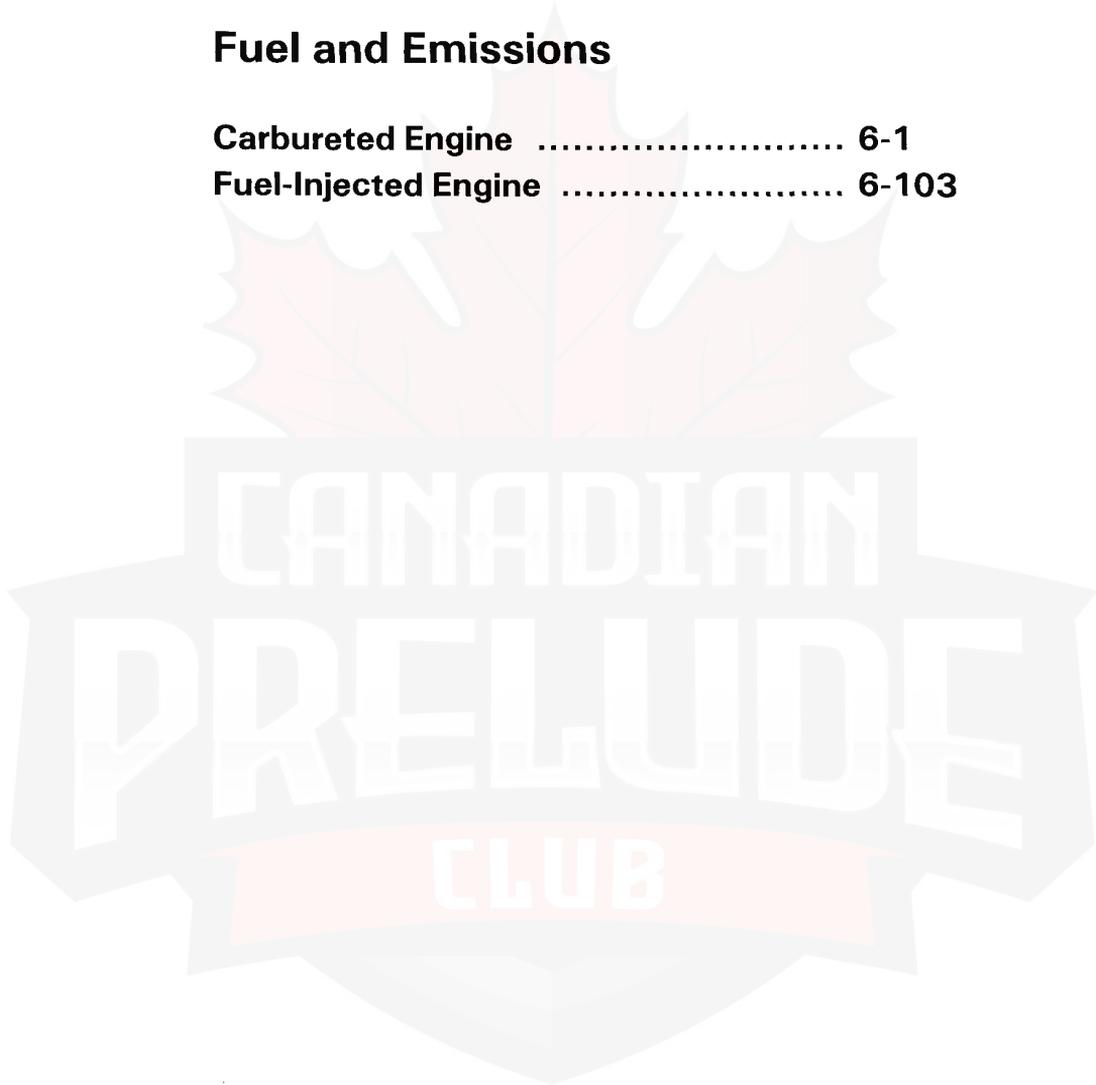

Fuel and Emissions (Carbureted Engine)

Special Tools	6-2	Carburetor	
Component Locations		Symptom-to-Sub System Chart	6-48
Index	6-3	Idle Control System	6-50
System Description		Slow Air Jet Control System	6-64
Vacuum Connections	6-6	Primary Slow Mixture Cut-off	
Electrical Connections	6-13	Solenoid Valve	6-66
Troubleshooting		Vacuum Piston Control System	6-68
Self-Diagnostic Procedures	6-15	Idle Speed/Mixture	6-71
How to Read Flowcharts	6-17	Power Valve	6-77
PGM-CARB Control System		Replacement	6-80
Symptom-to System Chart	6-18	Fuel Supply System	
Troubleshooting Flowcharts		Symptom-to-Sub System Chart	6-81
Oxygen Sensor	6-20	Fuel Pump	6-82
Vehicle Speed Sensor	6-22	Emission Control System	
Manifold Absolute Pressure		Symptom-to-Sub System Chart	6-83
Sensor	6-24	Catalytic Converter	6-84
Vacuum Switch	6-28	Feedback Control System	6-85
Coolant Temperature Sensor	6-32	Air Injection Control	6-88
Ignition Coil Signal	6-34	EGR	6-91
Intake Air Temperature		Evaporative Emission Controls	6-93
Sensor	6-36		
Input Troubleshooting Flowcharts			
Power Source (IG1, Bat)			
and Ground	6-38		
Air Conditioning Signal	6-40		
Clutch Switch Signal	6-42		
A/T Shift Position Signal	6-44		
P/S Oil Pressure Switch			
Signal	6-46		



Outline of Model Change

- The vacuum hose manifold has been modified.
- The PGM-CARB control unit has been modified.
- The carburetor has been modified.
- The power valve control solenoid valve has been adopted.
- The inspection of power valve has been modified.

Special Tools

Ref. No.	Tool Number	Description	Q'ty	Remarks
①	07LAJ-PT30100	ECU Test Harness	1	

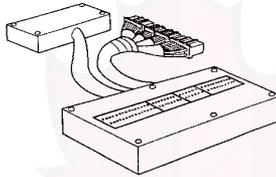

①

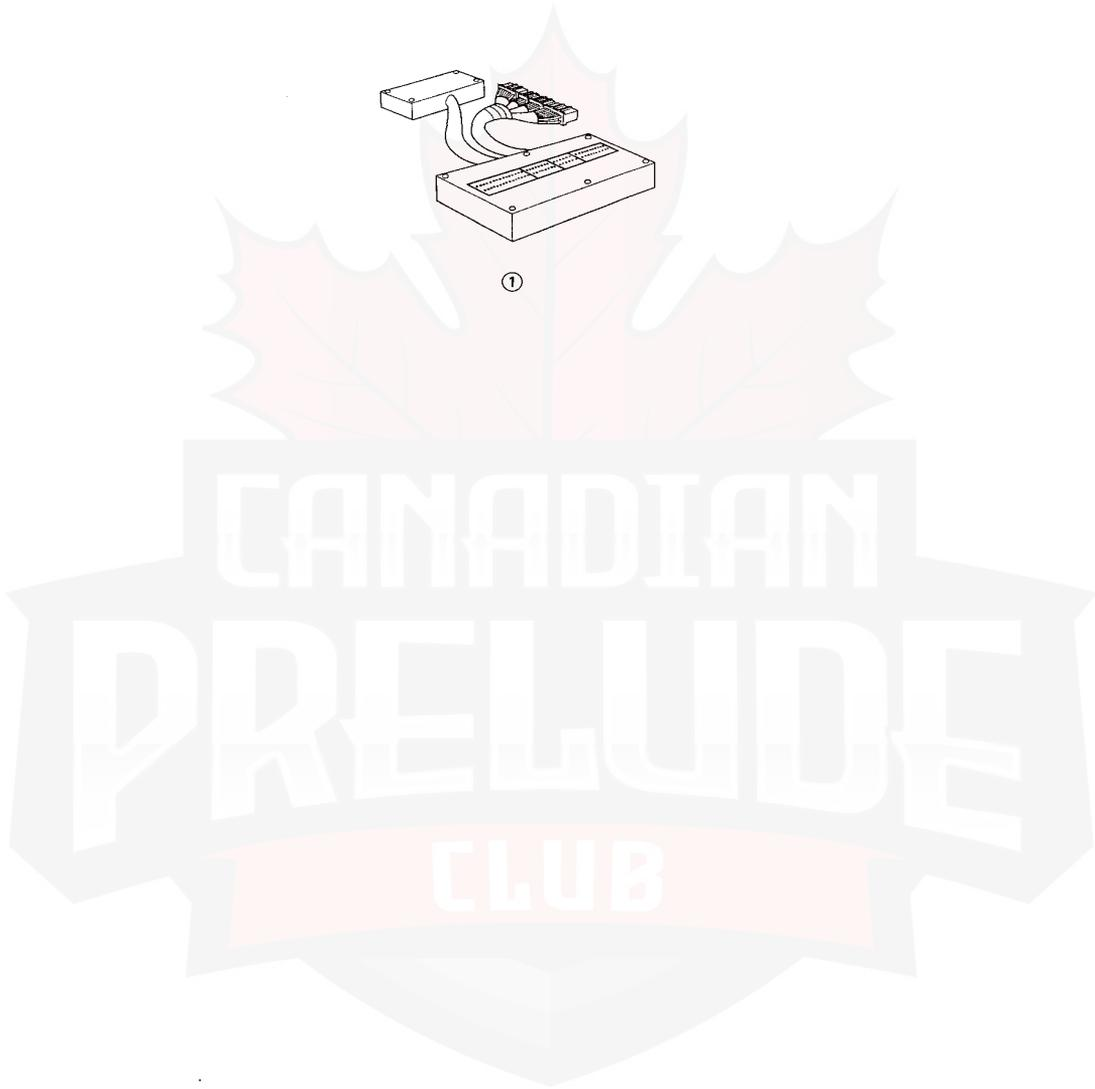

Component Locations



Index

[KX, KS, KZ model]

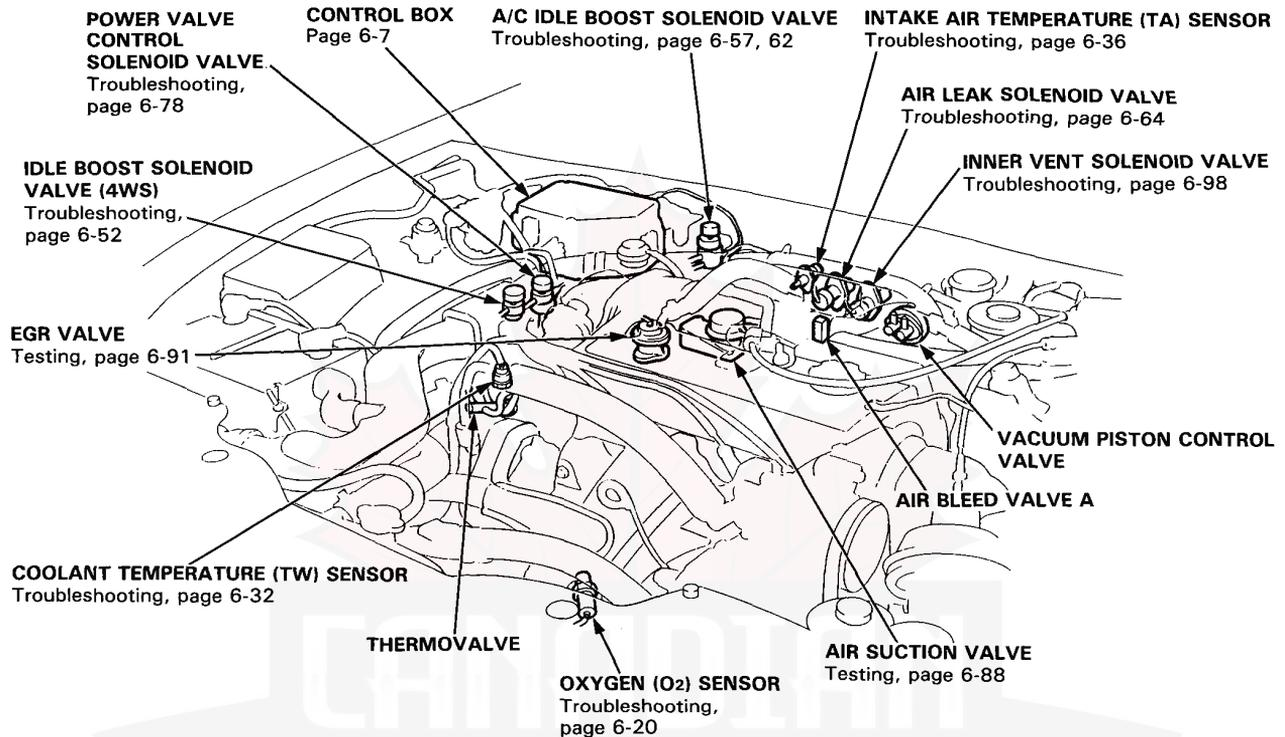

[KF, KG, KW, KB, KY model]

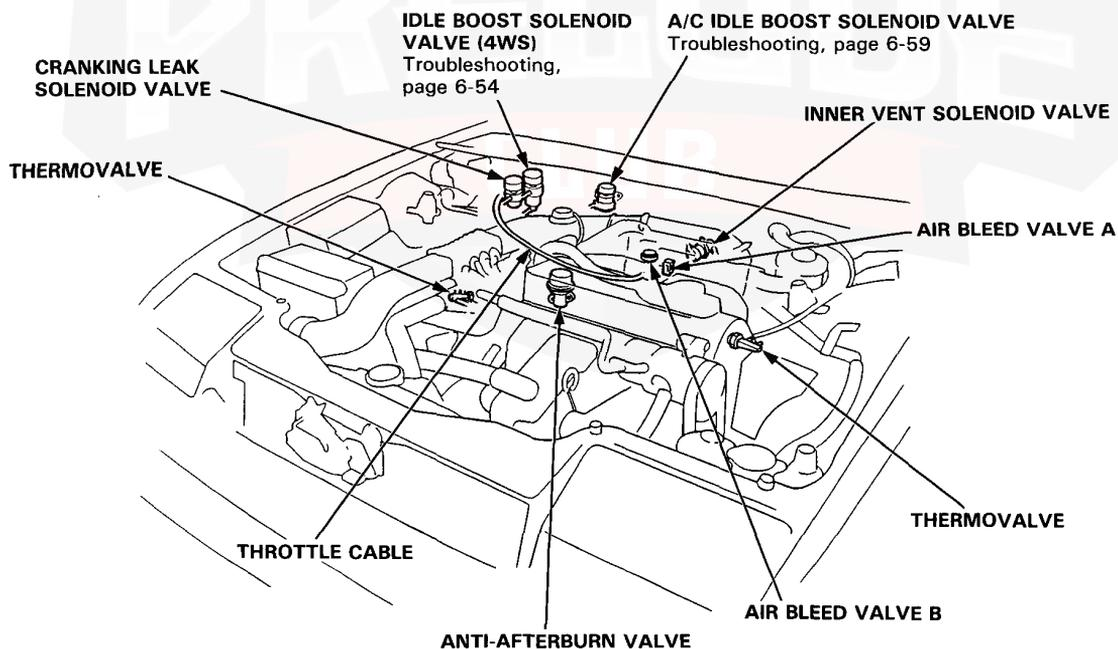

(cont'd)

Component Locations

Index (cont'd)

[KE, KT model]

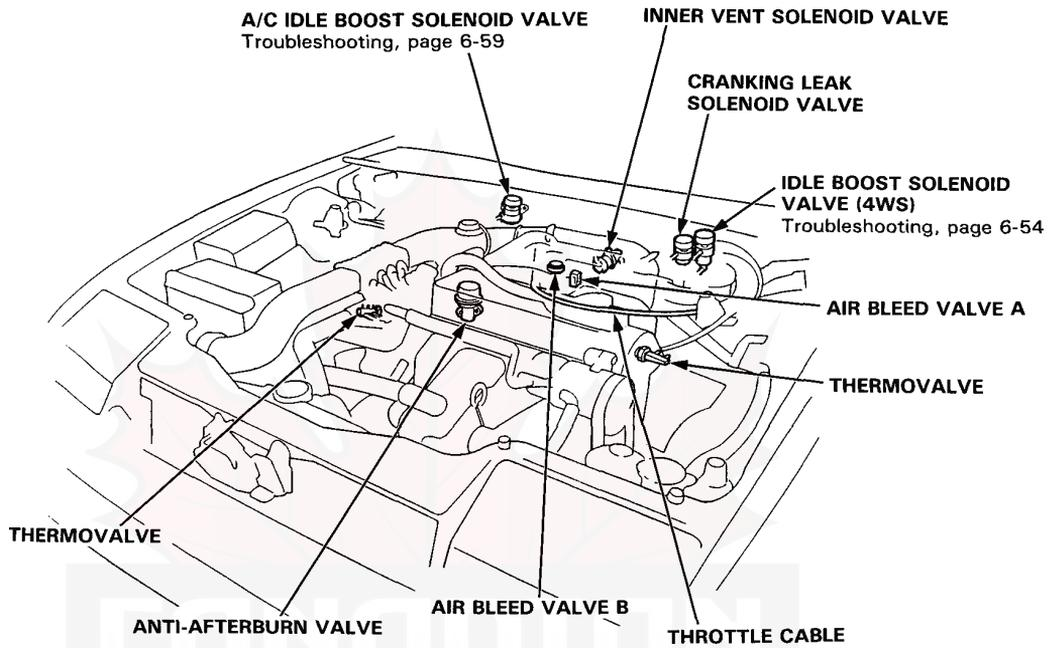



**INTAKE AIR CONTROL
DIAPHRAGM**

AIR CLEANER ELEMENT

- EC: Replace every 2 years or 40,000 km (24,000 miles) whichever comes first.
- Others: Replace every 1 year or 20,000 km (12,000 miles) whichever comes first.

AIR INTAKE TUBE

THROTTLE CABLE

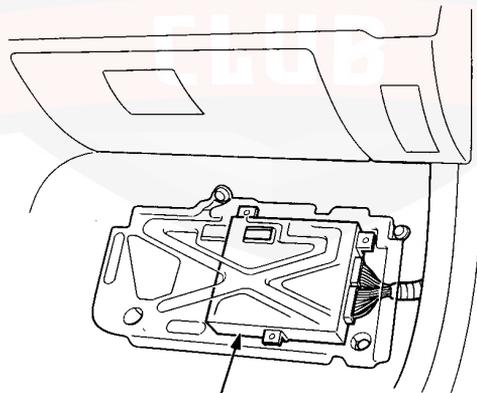

PGM-CARB CONTROL UNIT
Troubleshooting, page 6-18

System Description

Vacuum Connections

[KX, KS, KZ model]

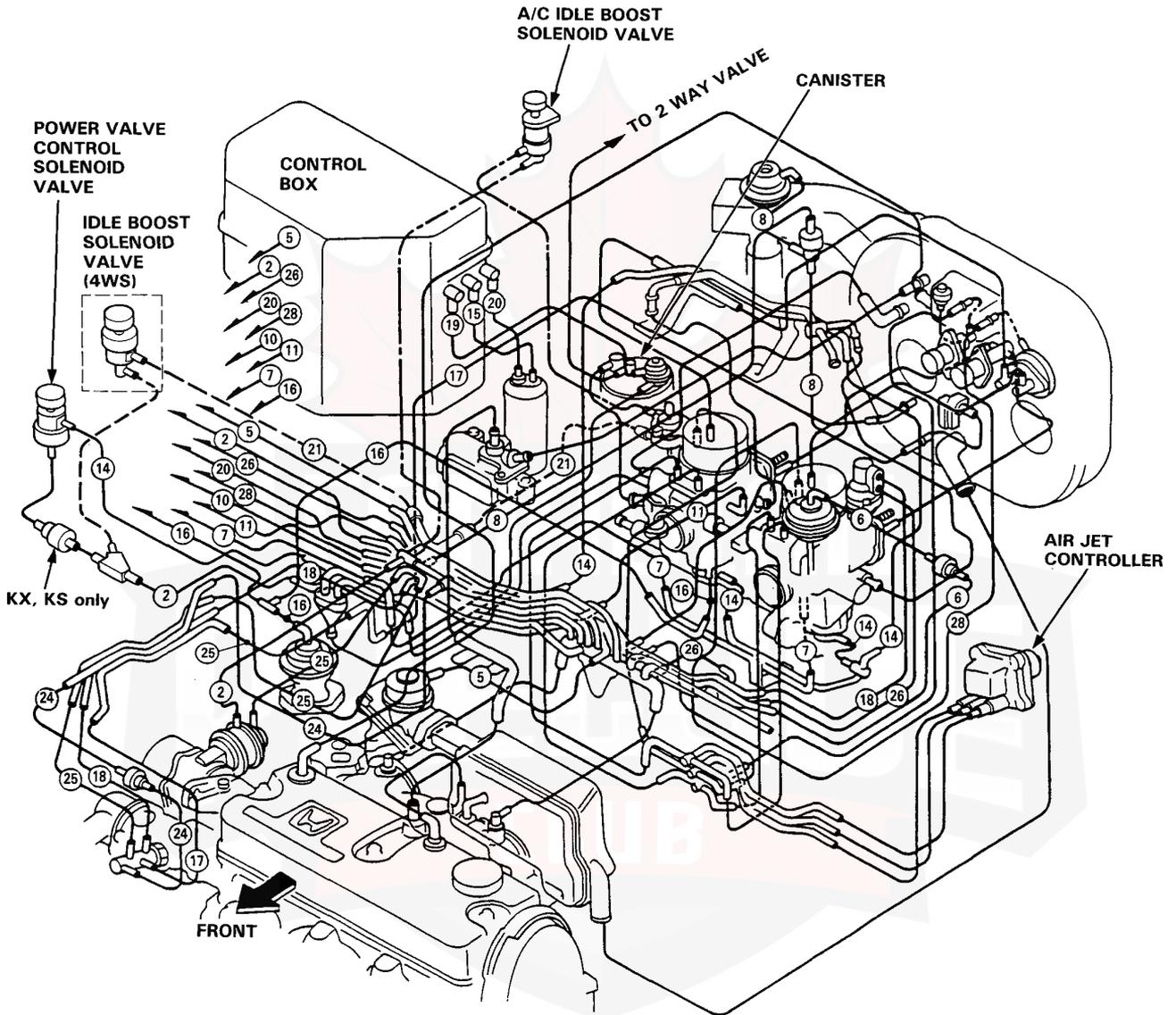



[KX, KS, KZ model]

Control Box

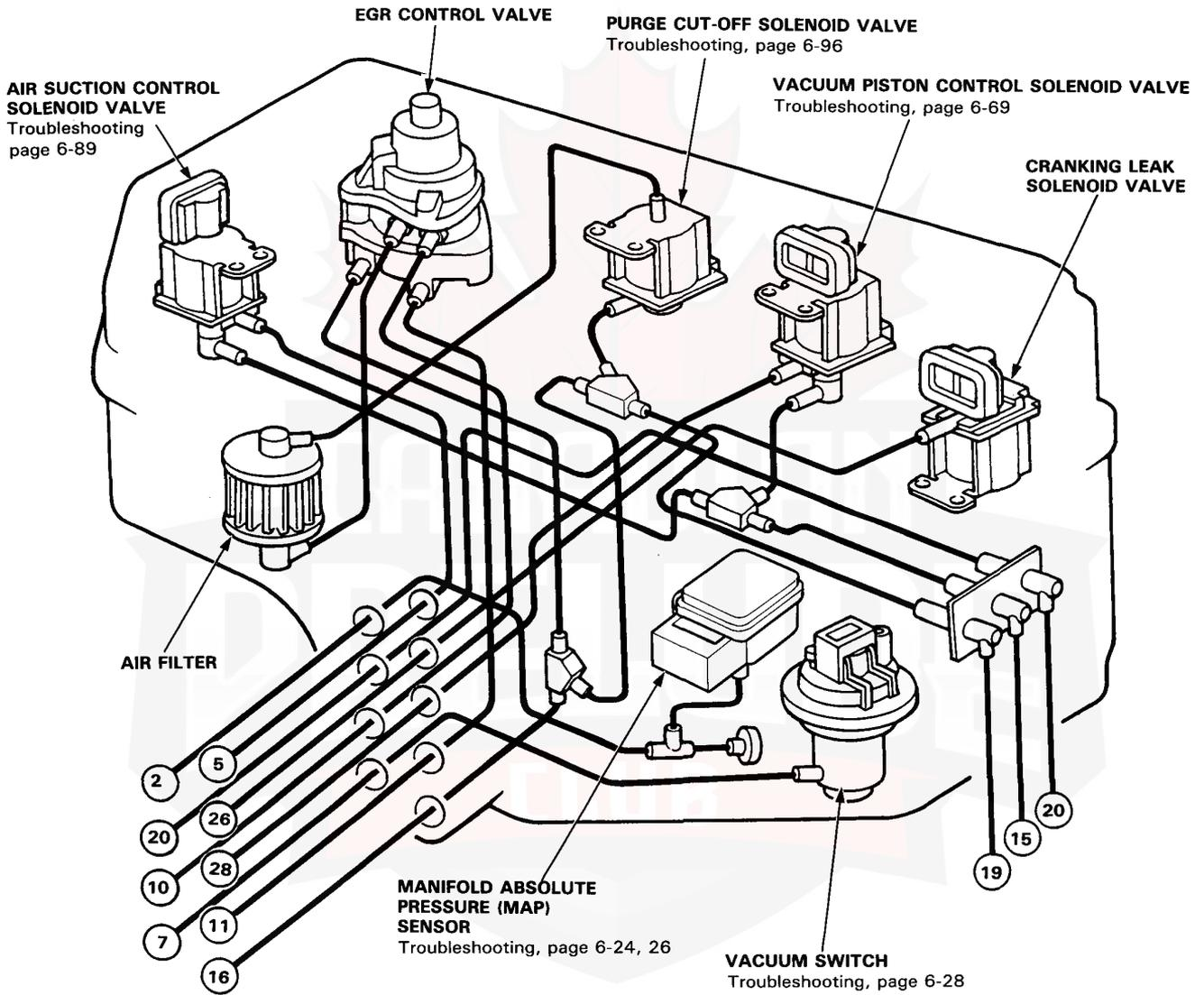

(cont'd)

System Description

Vacuum Connections (cont'd)

[KF, KG, KW, KB model]

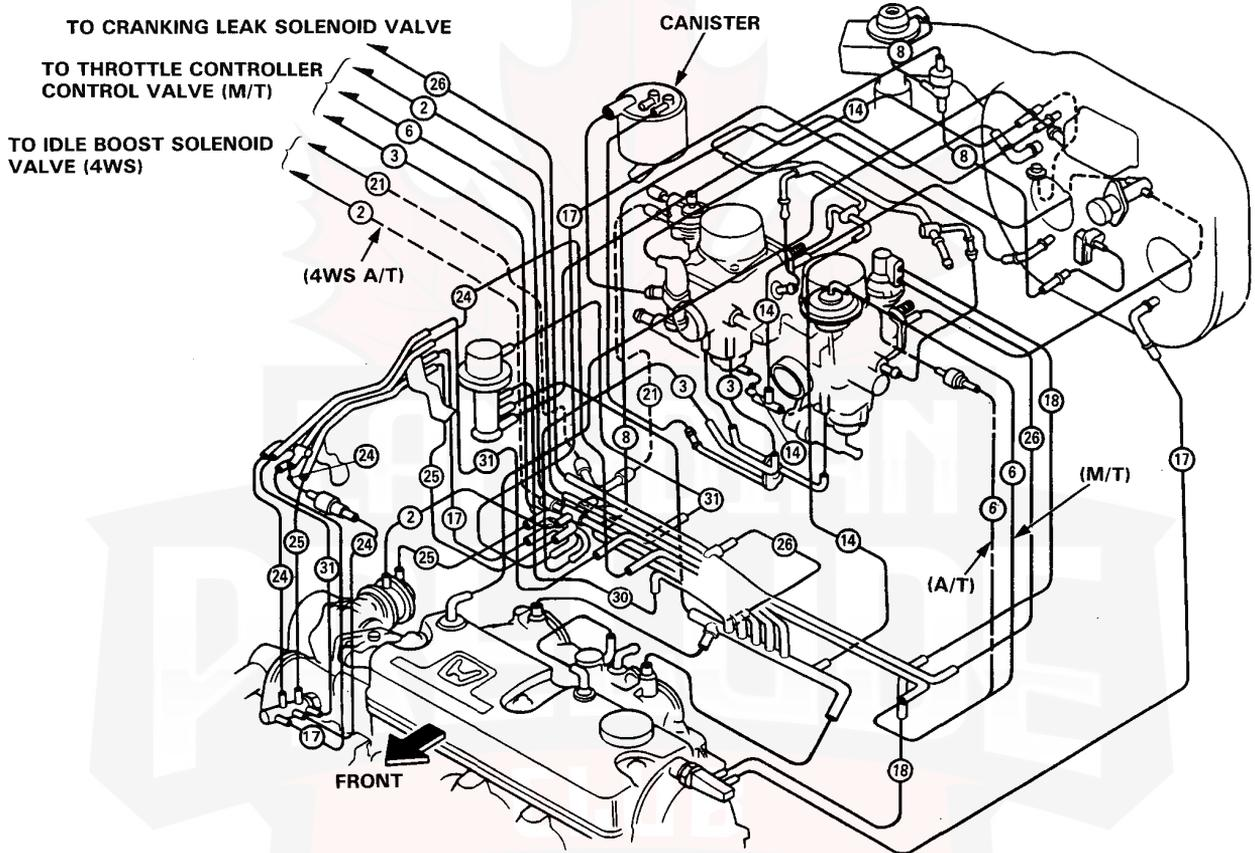



[KY model]

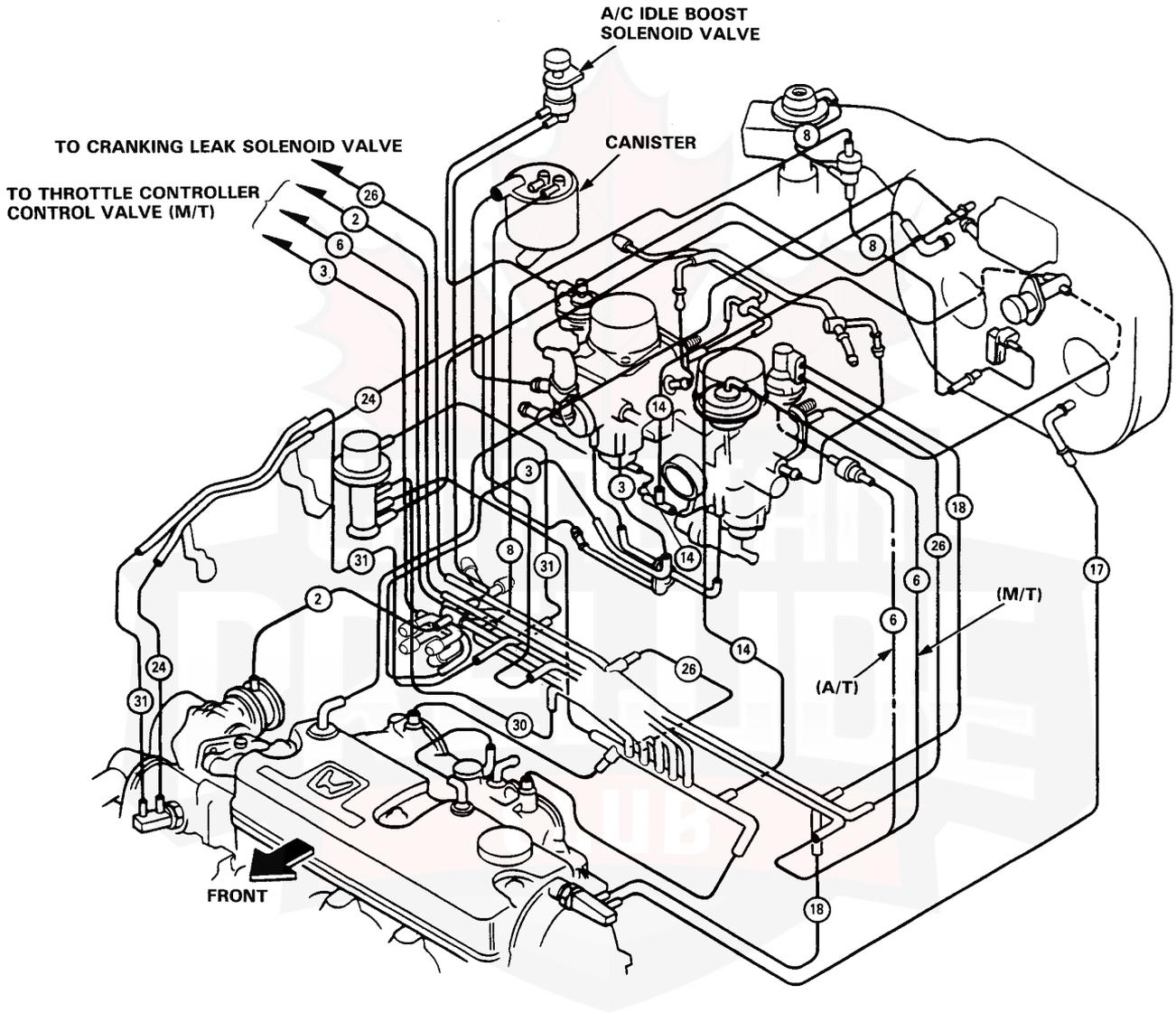

(cont'd)

System Description

Vacuum Connections (cont'd)

[KE model]

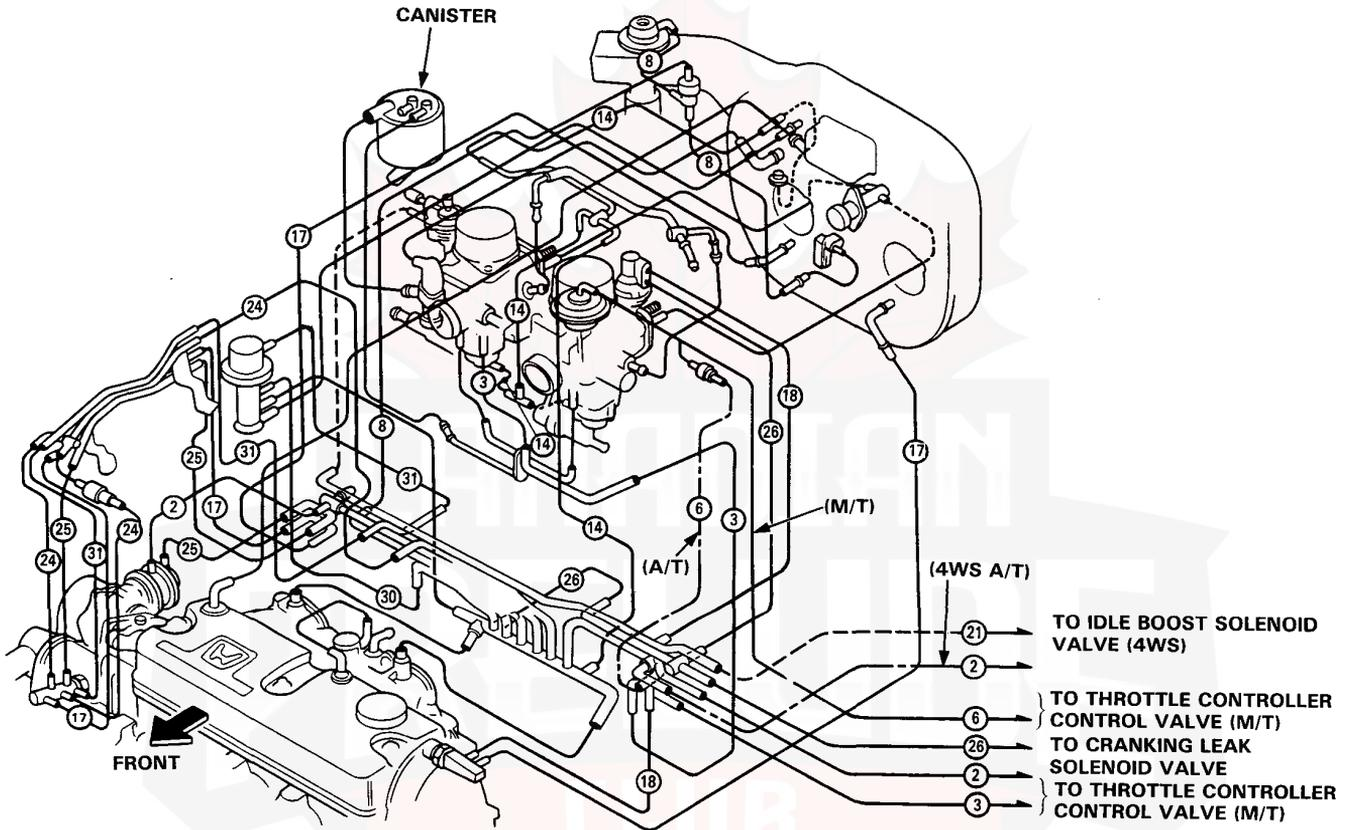



[KT model]

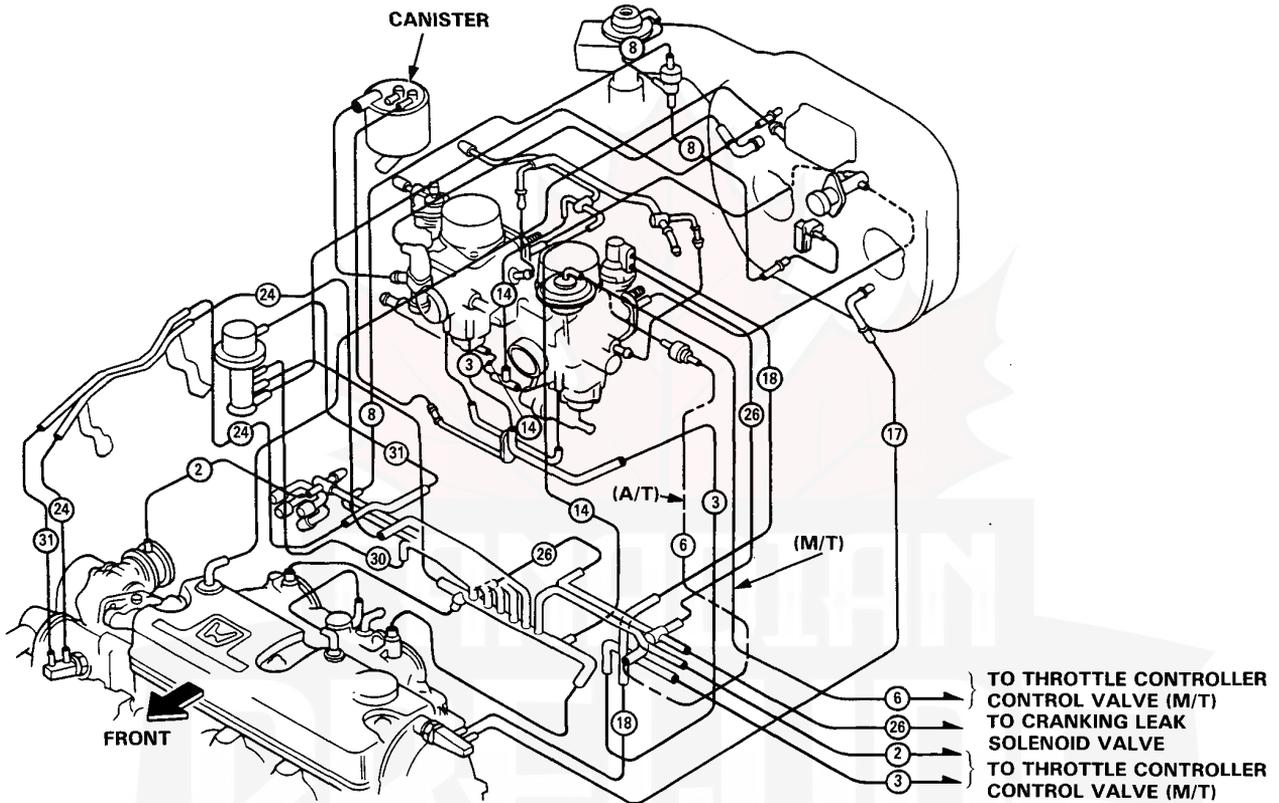

(cont'd)

System Description

Vacuum Connections (cont'd)

[KX, KS, KZ model]

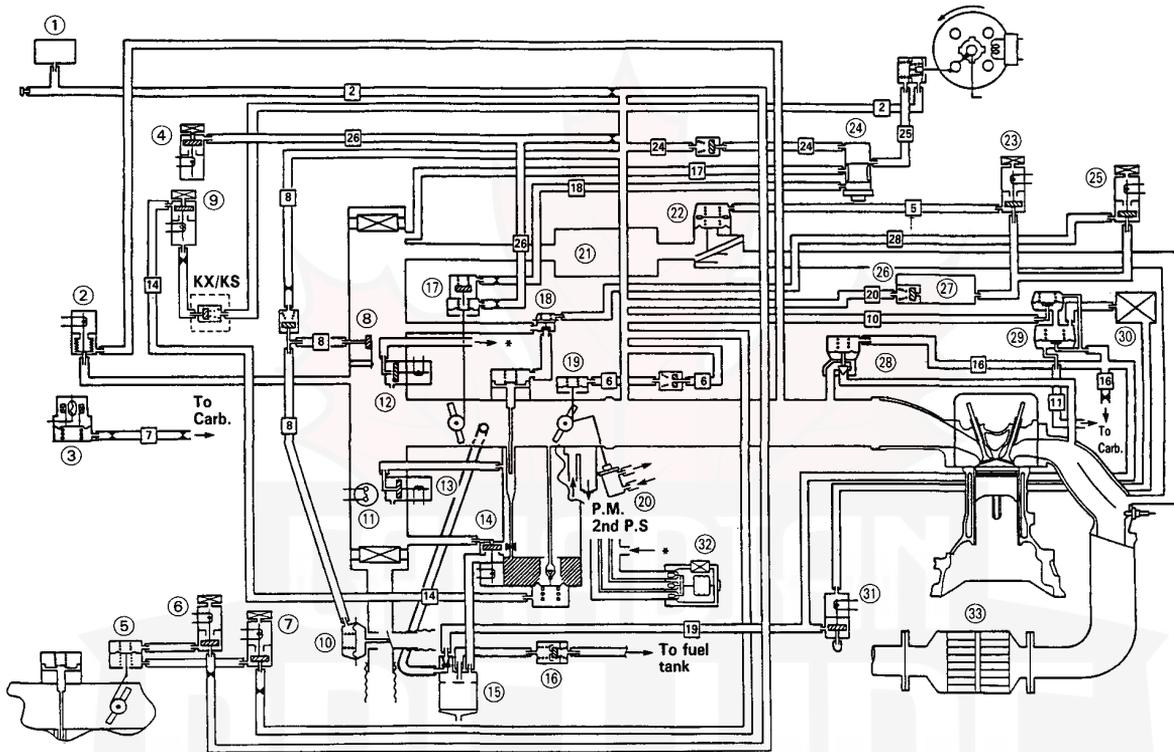

- ① MANIFOLD ABSOLUTE PRESSURE (MAP) SENSOR
- ② EACV
- ③ VACUUM SWITCH
- ④ CRANKING LEAK SOLENOID VALVE
- ⑤ IDLE BOOST THROTTLE CONTROLLER
- ⑥ A/C IDLE BOOST SOLENOID VALVE
- ⑦ IDLE BOOST SOLENOID VALVE
- ⑧ AIR BLEED VALVE A
- ⑨ POWER VALVE CONTROL SOLENOID VALVE
- ⑩ AIR CONTROL DIAPHRAGM
- ⑪ INTAKE AIR TEMPERATURE (TA) SENSOR
- ⑫ AIR LEAK SOLENOID VALVE
- ⑬ INNER VENT SOLENOID VALVE
- ⑭ AIR VENT SOLENOID VALVE
- ⑮ CANISTER
- ⑯ TWO-WAY VALVE
- ⑰ CHOKE OPENER

- ⑱ VACUUM PISTON CONTROL VALVE
- ⑲ THROTTLE CONTROLLER
- ⑳ THERMOWAX VALVE
- ㉑ SILENCER
- ㉒ AIR SUCTION VALVE
- ㉓ AIR SUCTION CONTROL SOLENOID VALVE
- ㉔ THERMOVALVE
- ㉕ VACUUM PISTON CONTROL SOLENOID VALVE
- ㉖ CHECK VALVE C
- ㉗ AIR CHAMBER
- ㉘ EGR VALVE
- ㉙ EGR CONTROL VALVE
- ㉚ AIR FILTER
- ㉛ PURGE CUT-OFF SOLENOID VALVE
- ㉜ AIR JET CONTROLLER
- ㉝ CATALYTIC CONVERTER

Electrical Connections



[KX, KS, KZ model]

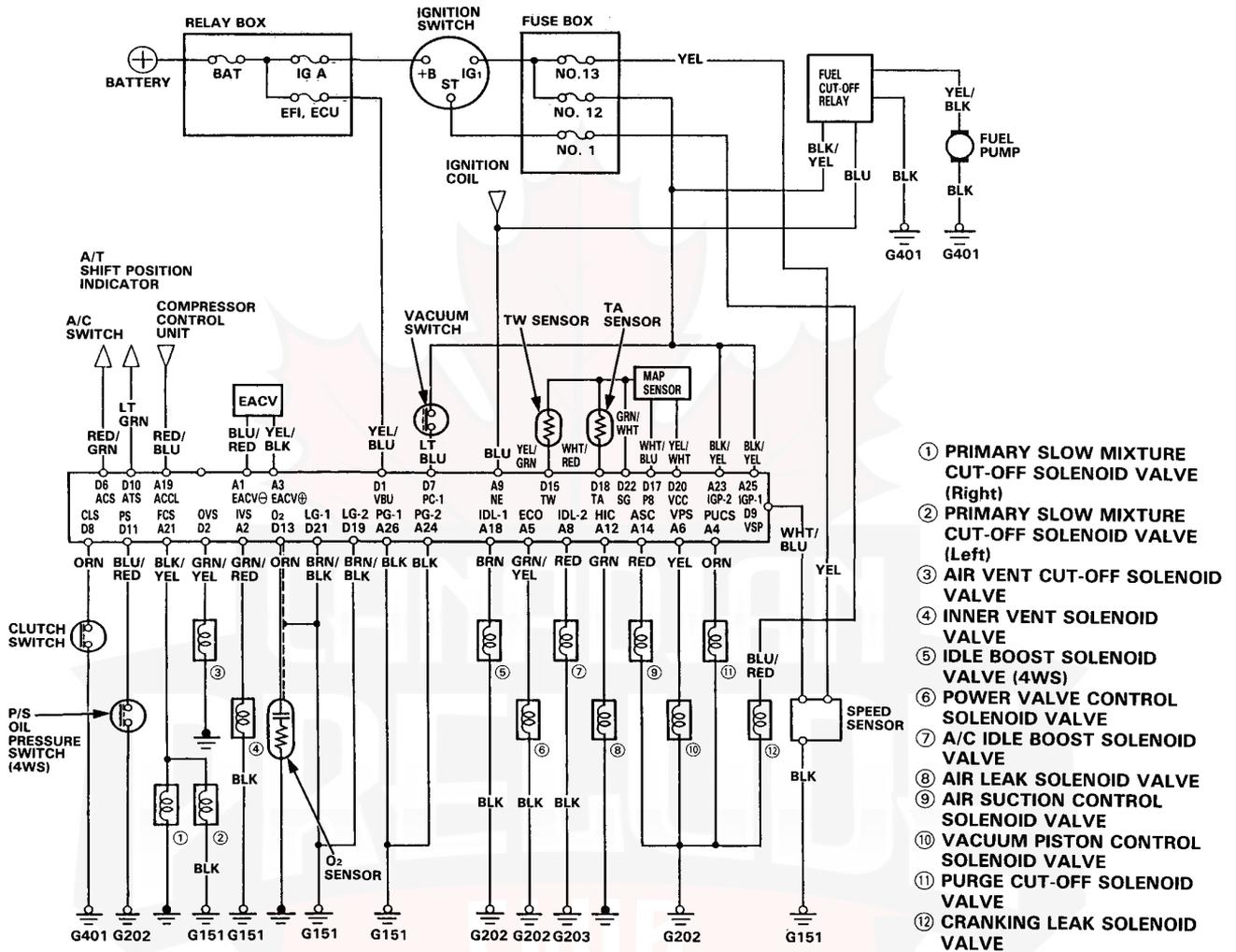

- ① PRIMARY SLOW MIXTURE CUT-OFF SOLENOID VALVE (Right)
- ② PRIMARY SLOW MIXTURE CUT-OFF SOLENOID VALVE (Left)
- ③ AIR VENT CUT-OFF SOLENOID VALVE
- ④ INNER VENT SOLENOID VALVE
- ⑤ IDLE BOOST SOLENOID VALVE (4WS)
- ⑥ POWER VALVE CONTROL SOLENOID VALVE
- ⑦ A/C IDLE BOOST SOLENOID VALVE
- ⑧ AIR LEAK SOLENOID VALVE
- ⑨ AIR SUCTION CONTROL SOLENOID VALVE
- ⑩ VACUUM PISTON CONTROL SOLENOID VALVE
- ⑪ PURGE CUT-OFF SOLENOID VALVE
- ⑫ CRANKING LEAK SOLENOID VALVE

NOT USED

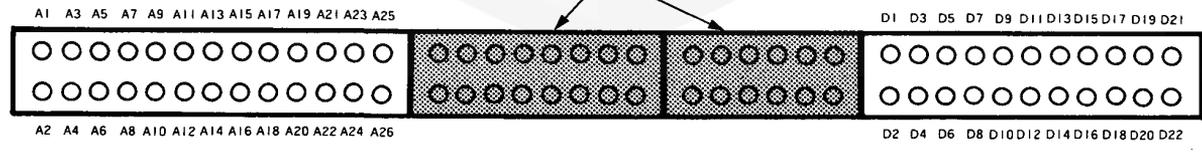

TERMINAL LOCATION

Electrical Connections

[Except KX, KS, KZ model]

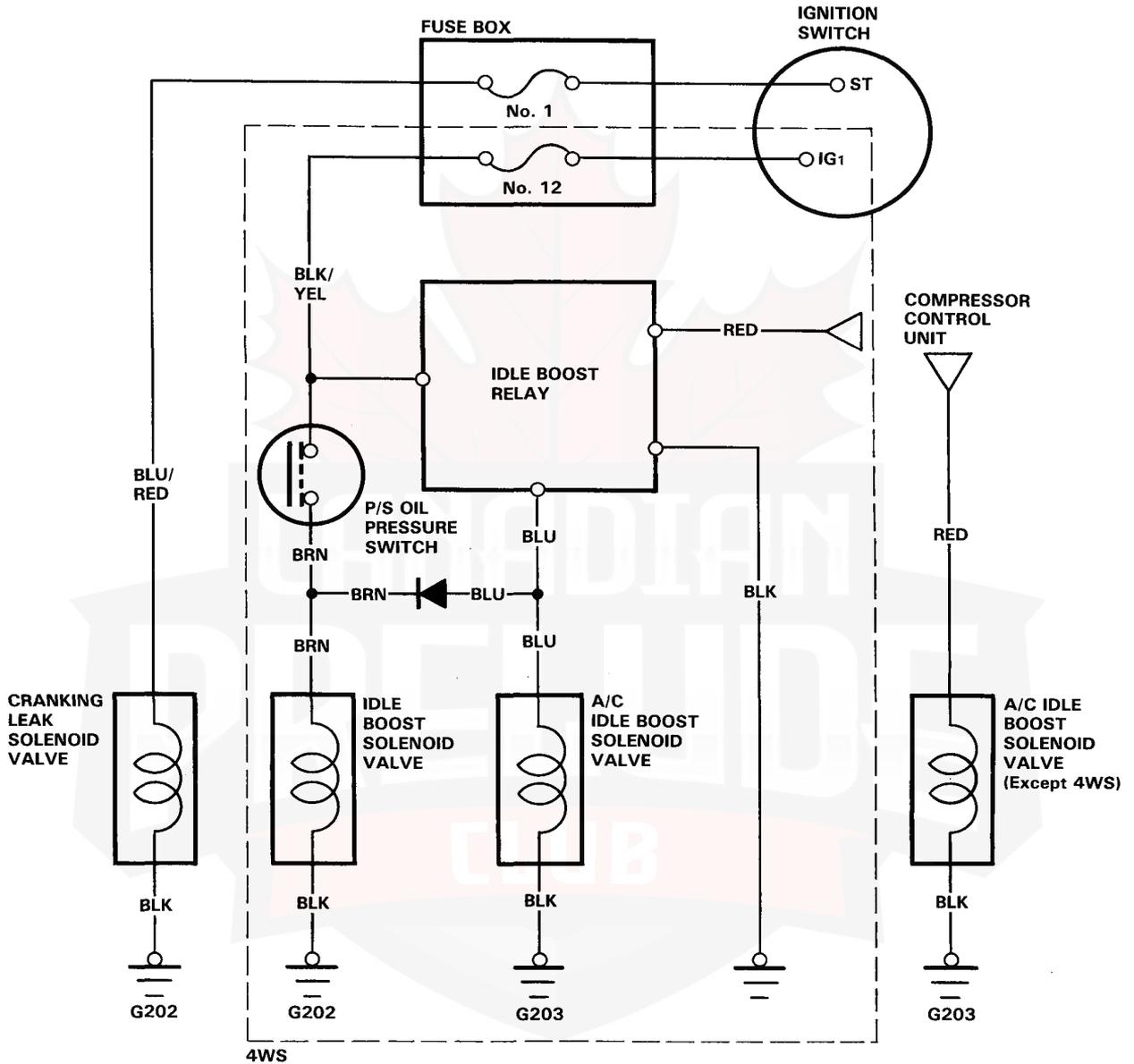

Self-Diagnostic Procedures



Turn the ignition on, pull down the passenger's side carpet inspection flap from under the dashboard and observe the LED on the top of the control unit. The LED indicates a system failure code by its blinking frequency.

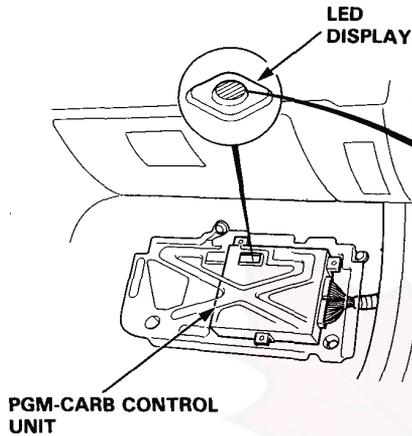

Separate Problems:

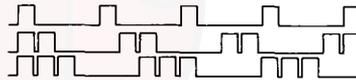

- = See Problem CODE 1
- = See Problem CODE 2
- = See Problem CODE 3

SELF-DIAGNOSIS INDICATOR BLINKS	SYSTEM INDICATED	PAGE
1	OXYGEN CONTENT	6-20
2	VEHICLE SPEED PULSER	6-22
3	MANIFOLD ABSOLUTE PRESSURE	6-24
4	VACUUM SWITCH SIGNAL	6-28
5	MANIFOLD ABSOLUTE PRESSURE	6-26
6	COOLANT TEMPERATURE	6-32
8	IGNITION COIL SIGNAL	6-34
10	INTAKE AIR TEMPERATURE	6-36
14	ELECTRONIC AIR CONTROL	6-86

If codes other than those listed above are indicated, count the number of blinks again; if the indicator is in fact blinking these codes, replace the original control unit.

The control unit LED may come on, indicating a system problem, when, in fact, there is a poor or intermittent electrical connection. First, check the electrical connections, clean or repair connections if necessary.

Self-Diagnostic Procedures

If the inspection for a particular failure code requires the ECU test harness, remove the right door sill molding, the small cover on the right kick panel, and pull the carpet back to expose the control unit. Unbolt the control unit from the bracket. Remove the control unit from the bracket. Connect the ECU test harness. Then check the system according to the procedure described for the appropriate code(s) listed on the following pages.

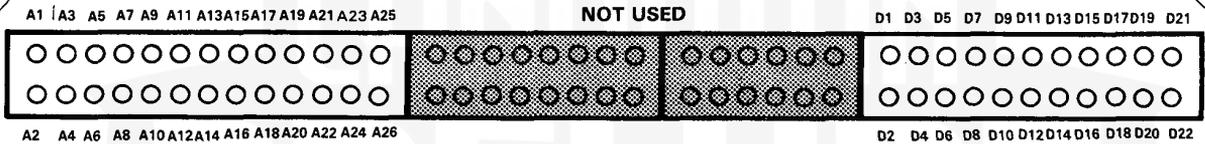
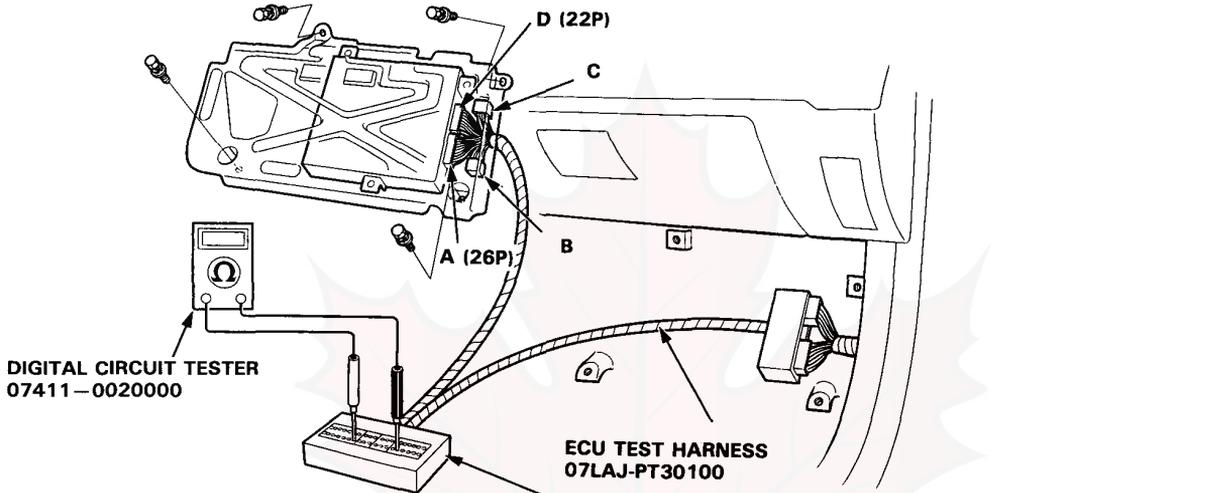

TERMINAL LOCATION

CAUTION:

- Puncturing the insulation on a wire can cause poor or intermittent electrical connections.
- For testing at connectors other than the ECU test harness, bring the tester probe into contact with the terminal from the connector side of wire harness in the engine compartment. For female connectors, just touch lightly with the tester probe and do not insert the probe.

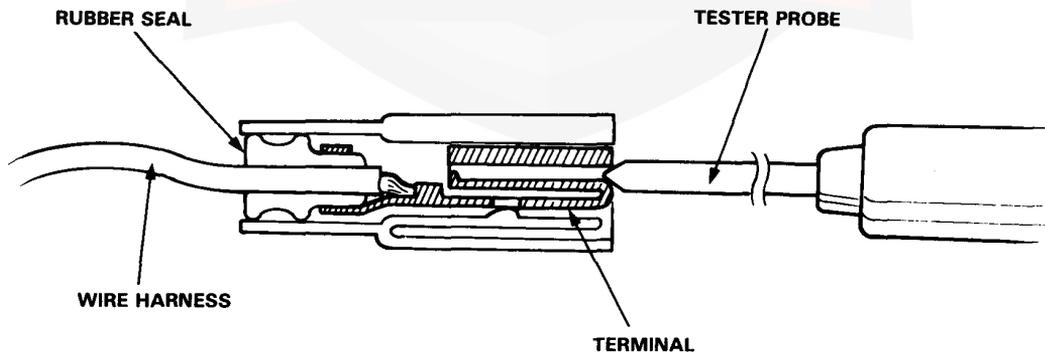



Troubleshooting

How to Read Flowcharts

A flow chart is designed to be used from start to final repair. It's like a map showing you the shortest distance. But beware; if you go off the "map" anywhere but a "stop" symbol, you can easily get lost.

START
(bold type)

Describes the conditions or situation to start a troubleshooting flowchart.

ACTION

Asks you to do something; perform a test, set up a condition, etc.

DECISION

Asks you about the result of an action by giving an "answer" and asking did you get the same answer: Yes or No.

STOP

(bold type)

The end of a series of actions and decisions, describes a final repair action and sometimes directs you to an earlier part of the flow to confirm your repair.

NOTE:

- The term "Intermittent Failure" is used several times in these charts. It simply means a system may have had a failure, but it checks out OK through all your tests. You may need to road test the car to reproduce the failure or if the problem was a loose connection, you may have unknowingly solved it while doing the tests.
- Most of the troubleshooting flowcharts have you reset the control unit and try to duplicate the problem code. If the problem is intermittent and you can't duplicate the code, do not continue through the flowchart. To do so will only result in confusion and possibly, a needlessly replaced control unit.
- "Open" and "Short" are common electrical terms. An open is a break in a wire or at a connection. A short is an accidental connection of a wire to ground. In simple electronics, this usually means something won't work at all. In complex electronics (like electronic control units), this can sometimes mean something works, but not the way it's supposed to.
- If the electrical readings are not as specified when using the ECU test harness, check the test harness connections before proceeding.

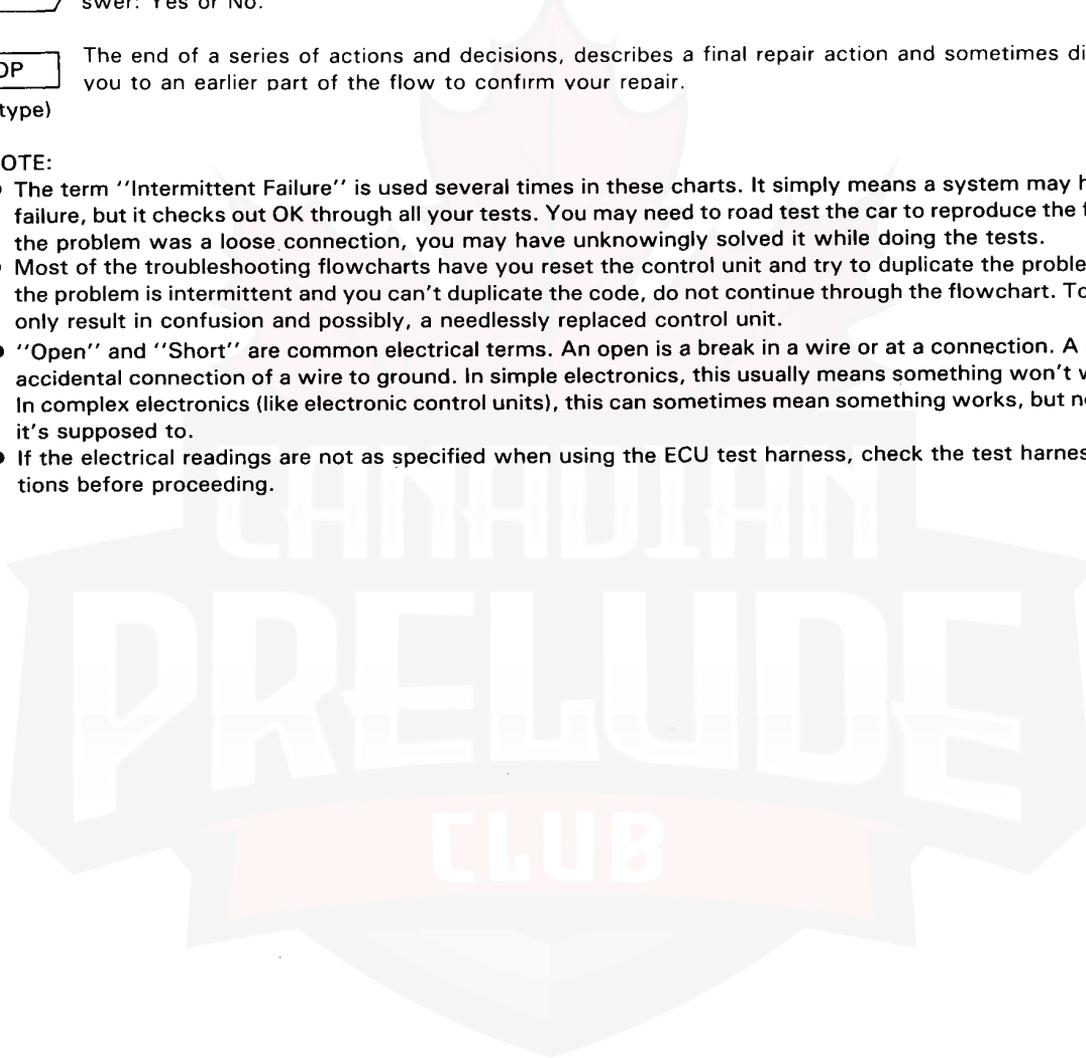

Symptom-to-System Chart

[KX, KS, KZ model]

NOTE: Across each row in the chart, the systems that could be sources of a symptom are ranked in the order they should be inspected starting with ①. Find the symptom in the left column, read across to the most likely source, then refer to the page listed at the top of that column. If inspection shows the system is OK, try the next most likely system ②, etc.

PAGE	SYSTEM	PGM-CARB CONTROL SYSTEM						
		PGM-CARB CONTROL UNIT	OXYGEN SENSOR	VEHICLE SPEED PULSER	MANIFOLD ABSOLUTE PRESSURE SENSOR	VACUUM SWITCH	COOLANT TEMPERATURE SENSOR	IGNITION COIL SIGNAL
	SYMPTOM	38	20	22	24, 26	28	32	34
	SELF DIAGNOSIS INDICATOR (LED) BLINKS	① or * 	① 	② 	③ or ⑤ 	④ 	⑥ 	⑧ 
	ENGINE WON'T START							
	DIFFICULT TO START ENGINE WHEN COLD	ⓑ					②	
IRREGULAR IDLING	WHEN COLD FAST IDLE OUT OF SPECIFIC	ⓑ					②	
	ROUGH IDLE	ⓑ			②			
	WHEN WARM ENGINE SPEED TOO HIGH	ⓑ						
	WHEN WARM ENGINE SPEED TOO LOW	ⓑ						
FREQUENT STALLING	WHILE WARMING UP	ⓑ			②		③	
	AFTER WARMING UP	ⓑ			②			
POOR PERFORMANCE	MISFIRE OR ROUGH RUNNING	ⓑ	③	③	②			
	FAILS EMISSION TEST	ⓑ	③		①			
	LOSS OF POWER	ⓑ			③			

* If codes other than those listed above are indicated, count the number of blinks again. If the indicator is in fact blinking these codes, replace the original control unit.

ⓑ: When the self-diagnosis indicator are on, the back-up system is in operation. Substitute a known-good control unit and recheck. If the indication goes away, replace the original control unit.



PGM-CARB CONTROL SYSTEM					CARBURETOR	FUEL SUPPLY	AIR INTAKE	EMISSION CONTROL	
INTAKE AIR TEMPERATURE SENSOR	A/C SIGNAL	CLUTCH SWITCH SIGNAL	A/T SHIFT POSITION SIGNAL	P/S OIL PRESSURE SWITCH (4WS)				ELECTRONIC AIR CONTROL VALVE	OTHER EMISSION CONTROL
36	40	42	44	46	48	81	—	86	83
⑩								⑭	
						①			
					①				
					①				③
③					①			③	③
	③		②	③	①				
					①			②	
					①			③	
					①				
					①	③			
					②		③	③	③
					③	②	①		③

PGM-CARB Control System

Troubleshooting Flowchart — Oxygen Sensor

 Self-diagnosis LED indicate code 1: A problem in the Oxygen (O₂) Sensor circuit.

LED indicates CODE 1.

Warm up engine to normal operating temperature (the cooling fan comes on).

Turn the ignition switch OFF.

Remove EFI, ECU fuse in the under-hood relay box for 10 seconds to reset control unit.

Start engine and allow to idle for 1 minute.

Raise engine speed to 3,000 min⁻¹ (rpm).

Remove #2 and #7 hose quickly from the vacuum hose manifold and plug the vacuum hose manifold.

Hold engine speed steady at 3,000 min⁻¹ (rpm) for 20 seconds.

Does LED indicate CODE 1?

NO

Intermittent failure, check and seat connectors at O₂ sensor, at the battery and at the control unit.

YES

Turn the ignition switch OFF.

(To page 6-21)

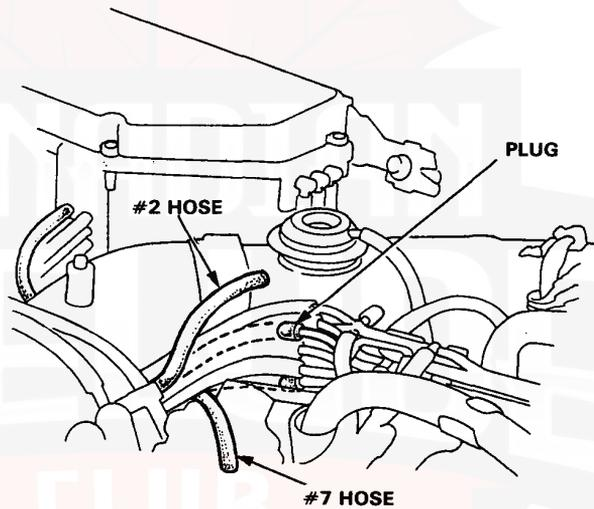



(From page 6-20)

Disconnect the wire harness from the O₂ sensor and connect a voltmeter between the O₂ sensor connector and engine ground.

Start the engine and measure the voltage between O₂ sensor connector and engine ground.

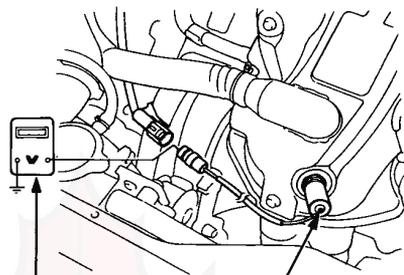

DIGITAL CIRCUIT TESTER
07411-0020000

O₂ SENSOR
45 N·m (4.5 kg·m, 33 lb·ft)

Is voltage above 0.6 at wide open throttle and below 0.4 when the throttle is quickly released?

NO
Replace O₂ sensor.

YES

Turn the ignition switch OFF.

Reconnect O₂ sensor.

Connect the ECU test harness between the control unit and connector (page 6-16).

Start the engine.

Measure voltage between D13 (+) terminal and D21 (-) terminal.



Is voltage above 0.6 V at wide open throttle and below 0.4 V when the throttle is quickly released?

NO
Repair open or short in WHT wire between the control unit (D13) and O₂ sensor.

YES

Substitute a known-good control unit and recheck. If symptom/indication goes away, replace the original control unit.

PGM-CARB Control System

Troubleshooting Flowchart — Vehicle Speed Sensor



Self-diagnosis LED indicates code 2: A problem in the Vehicle Speed Sensor circuit.

NOTE: Because it is an inter-related system, a leak in the vacuum switch or its hose may cause a "false" code 2 indication.

LED indicates CODE 2.

Connect the ECU test harness between the control unit and connector (page 6-16).

Block rear wheels and set the parking brake. Jack up the front of the car and support with safety stands.

Turn the ignition switch ON.

Slowly rotate left front wheel and measure voltage between D9 (+) terminal and D21 (-) terminal.

WARNING Block rear wheels before jacking up front of car.

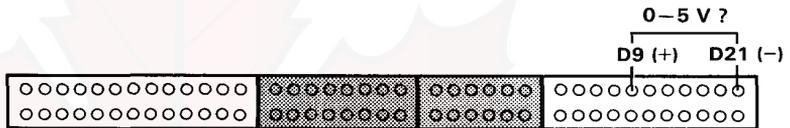

Does voltage pulse 0V and 5V ?

NO

Turn the ignition switch OFF.

Disconnect connector from the control unit only, not the wire harness.

Turn the ignition switch ON.

Slowly rotate left front wheel and measure voltage between D9 (-) terminal and A25 (+) terminal.

Does voltage pulse 0V and 12V ?

NO

— Repair open or short in WHT/BLU wire between control unit (D9) and the speed sensor.
— Replace speed sensor.

YES

Substitute a known-good control unit and recheck. If prescribed voltage is now available replace the original control unit.

— Raise the engine speed to 3,000 min⁻¹ (rpm) with no load, then check if the LED indicates CODE 2. If LED indicates CODE 2, repair vacuum leak in #7 hose or in vacuum switch.
— Substitute a known-good control unit and recheck. If prescribed voltage is now available replace the original control unit.

YES

0-12 V ?

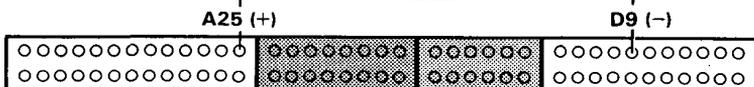



PGM-CARB Control System

Troubleshooting Flowchart — MAP Sensor

- 3 Self-diagnosis LED indicates code 3: Most likely an electrical problem in the Manifold Absolute Pressure (MAP) Sensor system.
- 5 Self-diagnosis LED indicates code 5: Most likely a mechanical problem (broken hose) in the Manifold Absolute Pressure (MAP) Sensor system.

3

- Engine is warm and running.
- LED indicates CODE 3.

Turn the ignition switch OFF.

Remove EFI, ECU fuse in the under-hood relay box for 10 seconds to reset control unit.

Start the engine and allow to idle.

Does LED indicate CODE 3?

NO

Intermittent failure
(test drive may be necessary).

YES

Turn the ignition switch OFF.

Connect the test harness between the MAP sensor and wire harness.

Turn the ignition switch ON.

Measure voltage between RED (+) terminal and GRN (-) terminal.

Is there approx. 5V?

NO

Measure voltage between RED (+) terminal and body ground.

YES

(To page 6-25)

Is there approx. 5V?

YES

Repair open in GRN/WHT wire between control unit (D22) and MAP sensor.

NO
(To page 6-25)

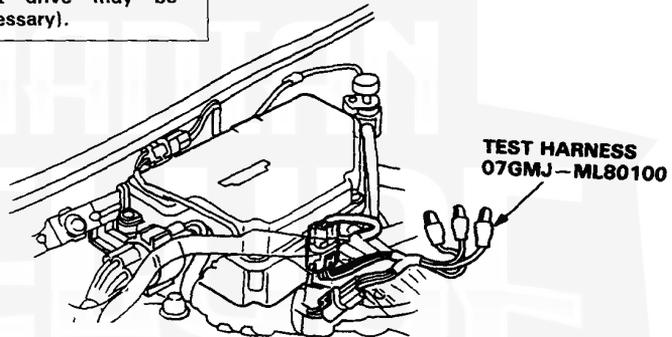

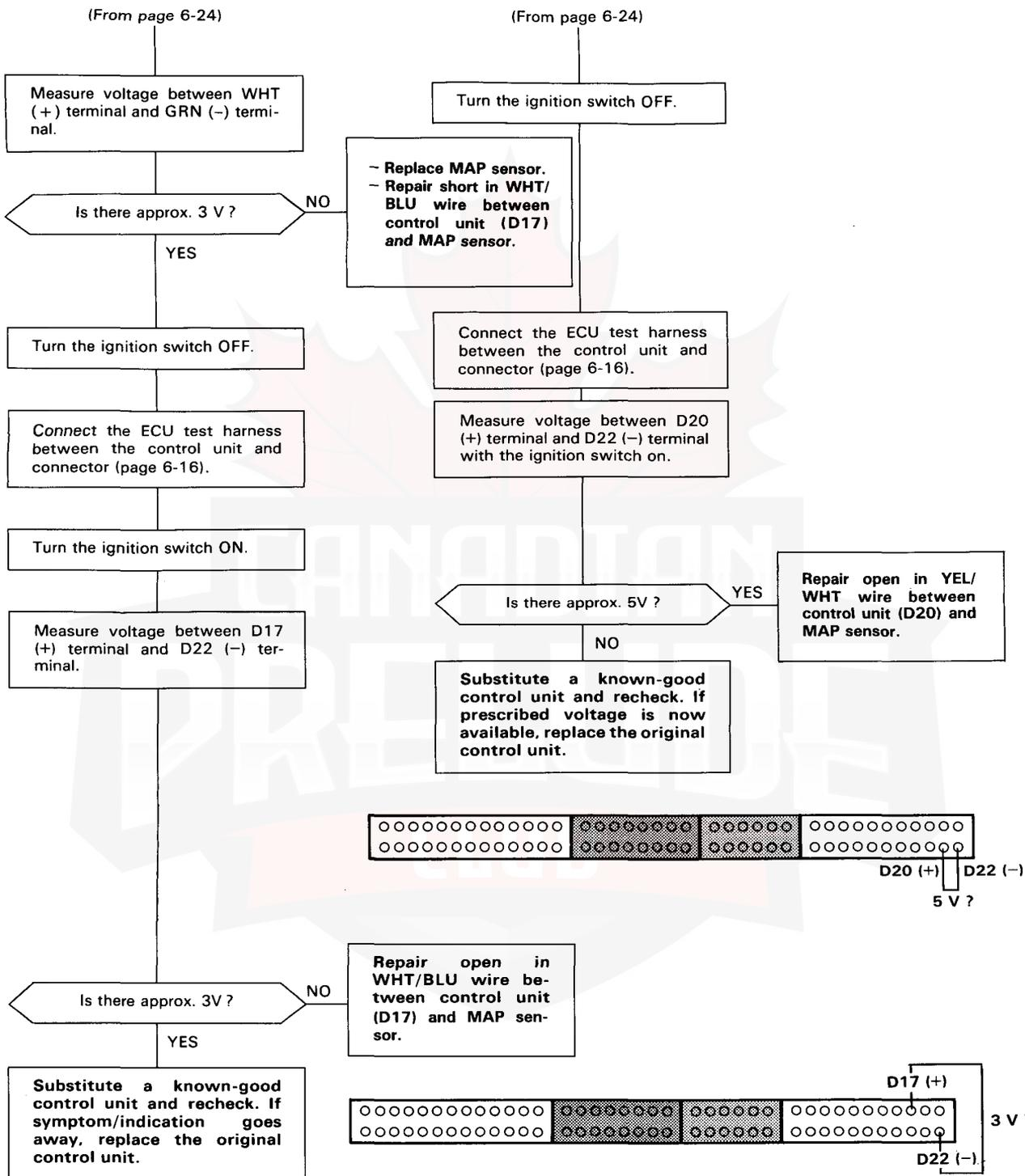

PGM-CARB Control System

Troubleshooting Flowchart — MAP Sensor



LED indicates CODE 5.

Turn the ignition switch OFF.

Remove EFI,ECU fuse in the under-hood relay box for 10 seconds to reset control unit

Start engine and keep engine speed at idle.

Does LED indicate CODE 5?

NO

Intermittent failure
(test drive may be necessary.)

YES

Stop engine.

VACUUM
PUMP/GAUGE

Remove #2 hose from the vacuum hose manifold and connect a T-fitting from a vacuum gauge between the vacuum hose manifold and the MAP sensor.

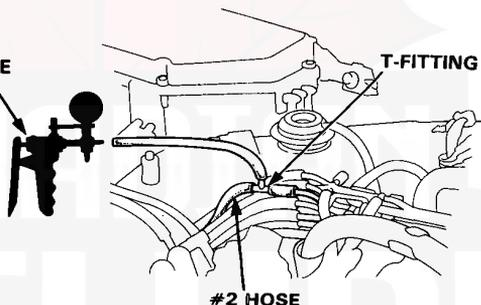

Start engine.

Is there vacuum?

NO

Repair as necessary.

YES

Connect a vacuum pump to #2 hose and apply vacuum.

Does it hold vacuum?

NO

Connect a vacuum pump directly to the MAP sensor and apply vacuum.

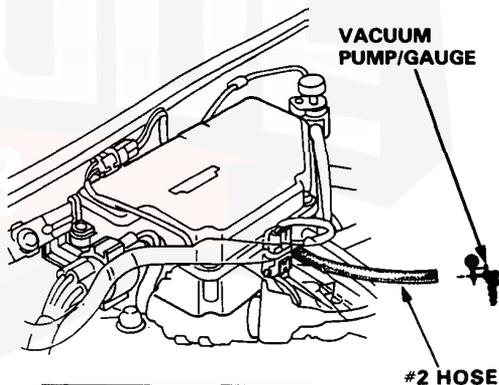

YES

Does it hold vacuum?

NO

Replace MAP sensor.

YES

Replace #2 hose.

(To page 6-27)



(From page 6-26)

Stop engine.

Connect the test harness between the MAP sensor and wire harness.

Turn the ignition switch ON.

Measure voltage between WHT (+) terminal and GRN (-) terminal.

Is there approx. 3V?

NO

Replace MAP sensor.

YES

Substitute a known-good control unit and recheck. If symptom/indication goes away, replace the original control unit.

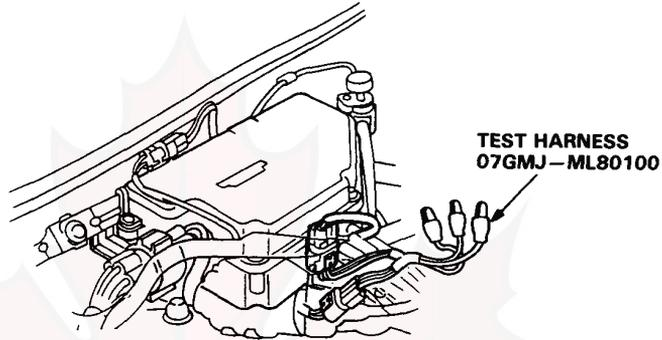

CANADIAN
PRELUDE
CLUB

PGM- CARB Control System

Troubleshooting Flowchart — Vacuum Switch

 Self-diagnosis LED indicates code 4: A problem in the vacuum switch.

— Engine is warm and running.
— LED indicates CODE 4.

Turn the ignition switch OFF.

Remove EFI,ECU fuse in the under-hood relay box for 10 seconds to reset control unit.

Start the engine and allow to idle for at least 30 seconds.

Does LED indicate CODE 4?

NO

Intermittent failure.
Check connectors at the control box and control unit.

YES

Turn the ignition switch OFF.

Disconnect the 8P connector on the control box.

Measure resistance between No.5 terminal and No.6 terminal on the control box.

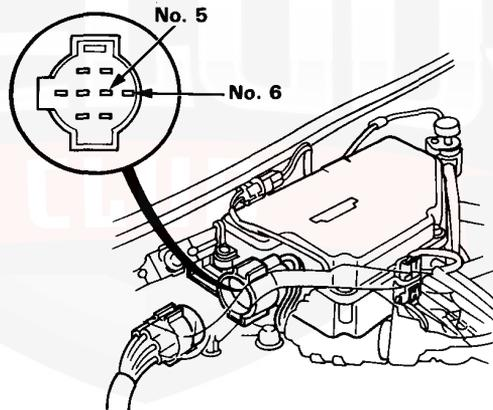

(To page 6-29)

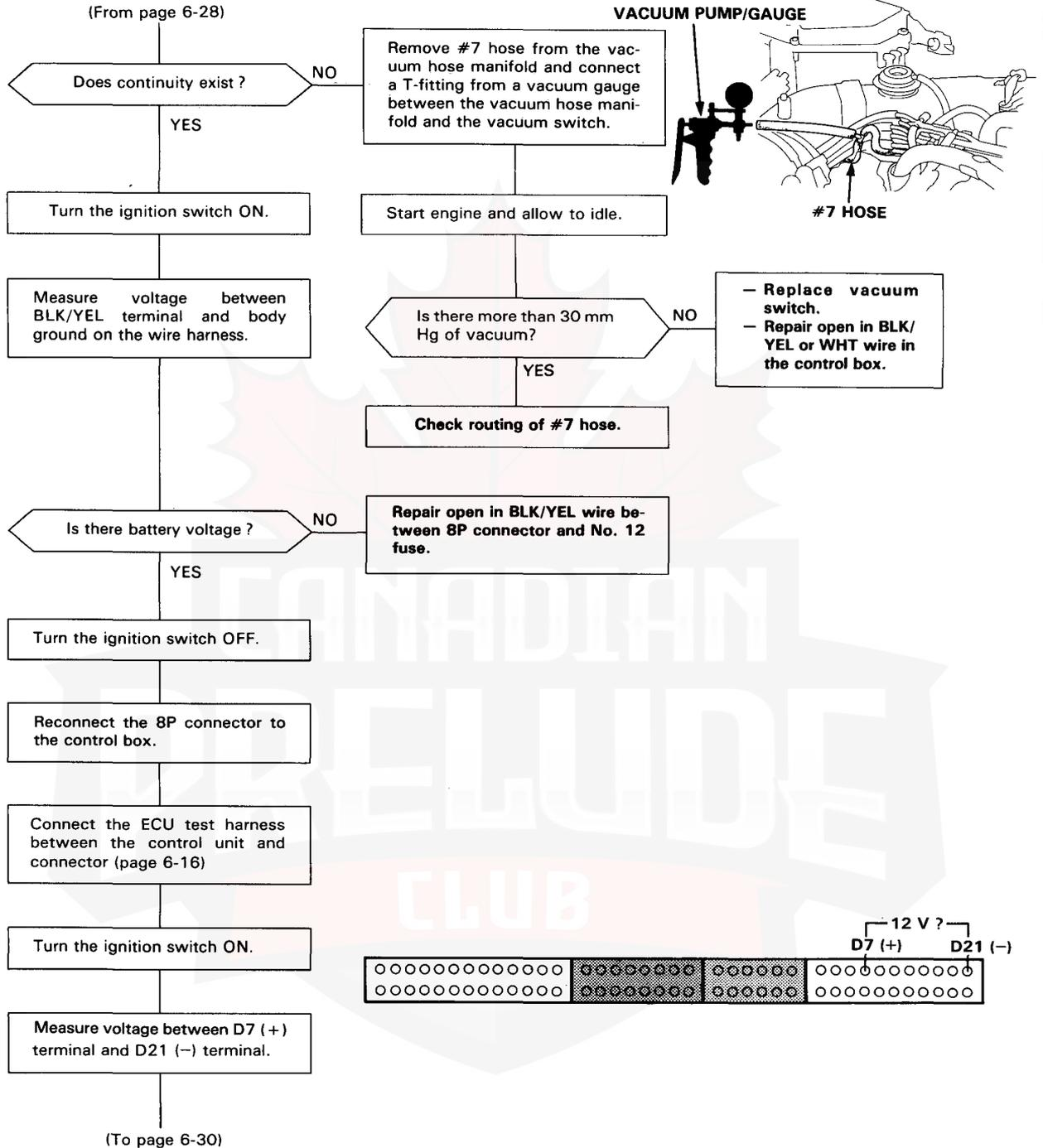

PGM-CARB Control System

Troubleshooting Flowchart — Vacuum Switch

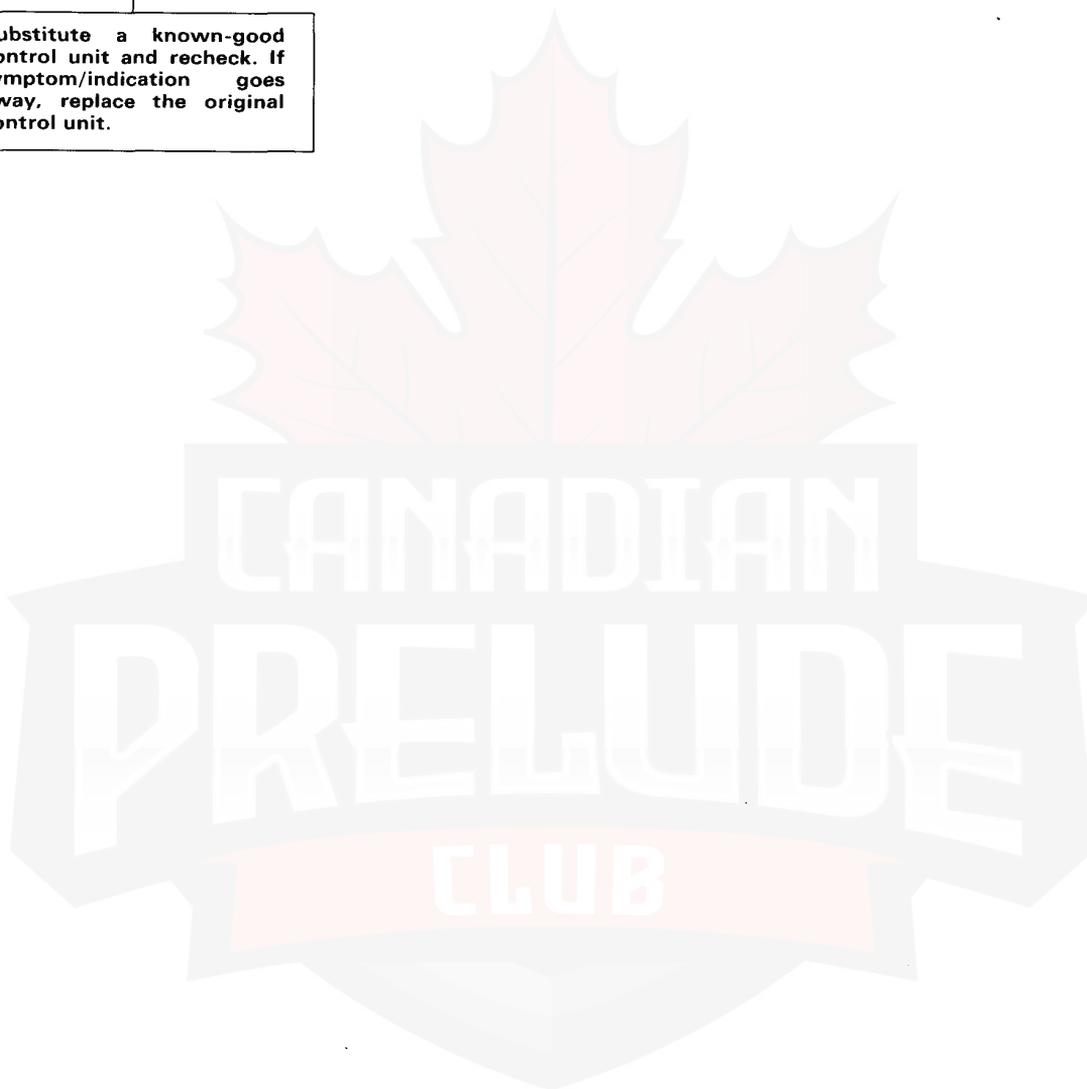
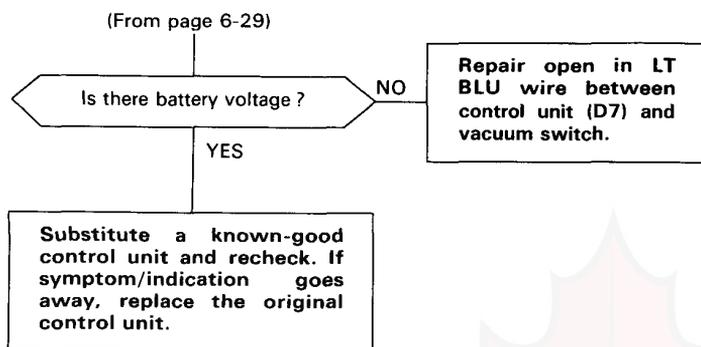



PGM-CARB Control System

Troubleshooting Flowchart — TW Sensor



Self-diagnosis LED indicates code 6: Most likely a problem in the Coolant Temperature (TW) Sensor circuit.

LED indicates CODE 6.

Turn the ignition switch OFF.

Remove EFI, ECU fuse in the under-hood relay box for 10 seconds to reset control unit.

Turn the ignition switch ON.

Does LED indicates CODE 6?

NO

Intermittent failure.
(test drive may be necessary.)

YES

Warm up engine to normal operating temperature (the cooling fan comes on).

Disconnect the 2P connector on the TW sensor.

Measure resistance between the 2 terminals on the TW sensor.

Is there 200—400Ω?

NO

Replace TW sensor.

YES

Measure voltage between YEL/GRN (+) terminal and body ground.

Is there approx. 5V?

NO

Turn the ignition switch OFF.

YES

Connect the ECU test harness between the control unit and connector (page 6-16).

(To page 6-33)

(To page 6-33)

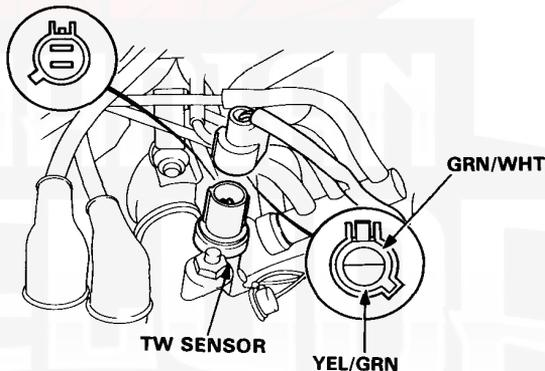



(From page 6-32)

(From page 6-32)

Measure voltage between YEL/GRN (+) terminal and GRN/WHT (-) terminal.

Is there approx. 5V ?

YES

Substitute a known-good control unit and recheck. If symptom/indiction goes away, replace the original control unit.

NO

Repair open in GRN/WHT wire between control unit (D22) and TW sensor.

Turn the ignition switch ON.

Measure voltage between D15 (+) terminal and D22 (-) terminal.

Is there approx. 5 V ?

YES

Repair open in YEL/GRN wire between control unit (D15) and TW sensor.

NO

Disconnect D connector from the wire harness only, not the control unit.

Measure voltage between D15 (-) terminal and D22 (-) terminal.

Is there approx. 5V ?

YES

- Repair short in YEL/GRN wire between control unit (D15) and TW sensor.
- Repair short in YEL/GRN wire between A/T control unit and TW sensor.

NO

Substitute a known-good control unit and recheck. If prescribed voltage is now available, replace the original control unit.

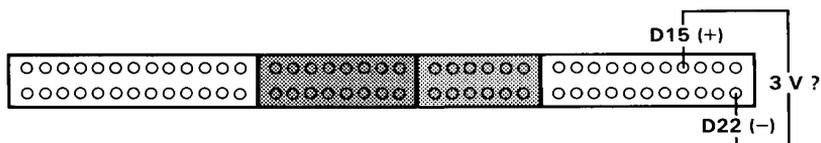

PGM-CARB Control System

Troubleshooting Flowchart — Ignition Coil Signal



Self-diagnosis LED indicates code 8: A problem in the ignition coil signal circuit.

LED indicates CODE 8.

Turn the ignition switch OFF.

Remove EFI, ECU fuse in the under-hood relay box for 10 seconds to reset control unit.

Start the engine and allow to idle.

Does LED indicate CODE 8?

NO

Intermittent failure.
Check the connectors at the ignition coil and control unit.

YES

Turn the ignition switch OFF.

Disconnect the primary terminals from the ignition coil.

Measure resistance between the B and D terminals.

Is there approx. 2000 Ω ?

NO

Replace ignition coil.

YES

Reconnect the primary terminals to the ignition coil.

(To page 6-35)

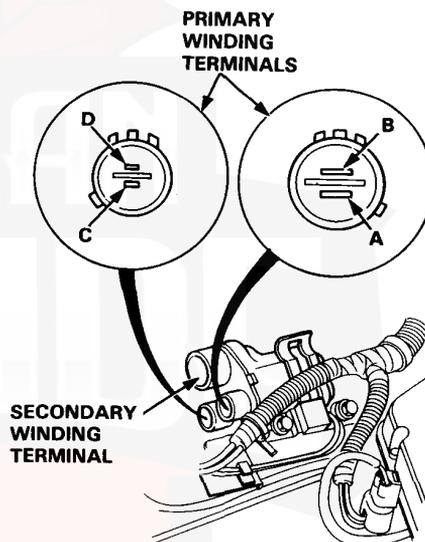



(From page 6-34)

Connect the ECU test harness to main wire harness, but not the control unit (page 6-16).

Turn the ignition switch ON.

Measure voltage between A9 (+) terminal and D21 (-) terminal.

Is there approx. 10 V?

NO

Repair open BLU wire between control unit (A9) and ignition coil.

YES

Substitute a known-good control unit and recheck. If symptom/indication goes away, replace the original control unit.

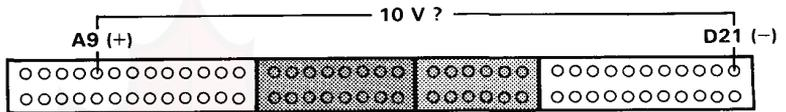

PGM-CARB Control System

Troubleshooting Flowchart — TA Sensor



Self-diagnosis LED indicates code 10: Most likely a problem in the Intake Air Temperature (TA) Sensor circuit

LED indicates CODE 10.

Turn the ignition switch OFF.

Remove EFI, ECU fuse in the under-hood relay box for 10 seconds to reset control unit.

Turn the ignition switch ON.

Does LED indicate CODE 10?

NO Intermittent failure (test drive may be necessary.)

YES

Disconnect the 2P connector on the TA sensor.

Measure resistance between the 2 terminals on the TA sensor.

Is there 1—4 k Ω ?

NO Replace TA sensor.

YES

Measure voltage between WHT/RED (+) terminal and body ground.

Is there approx. 5V?

NO Turn the ignition switch OFF.

YES

Measure voltage between WHT/RED (+) terminal and GRN/WHT (-) terminal.

Connect the ECU test harness between the control unit and connector (page 6-16).

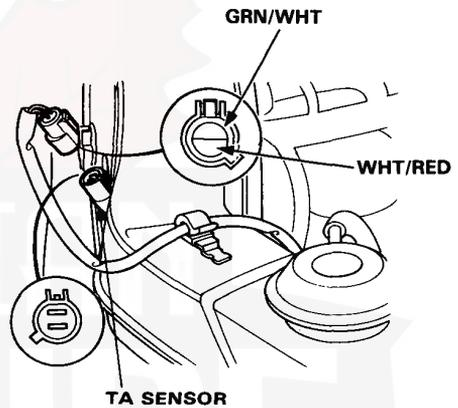

(To page 6-37)

(To page 6-37)

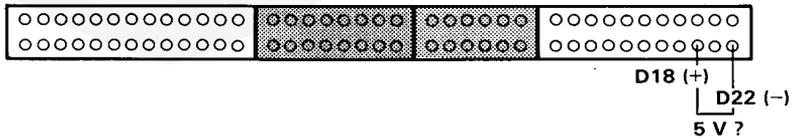
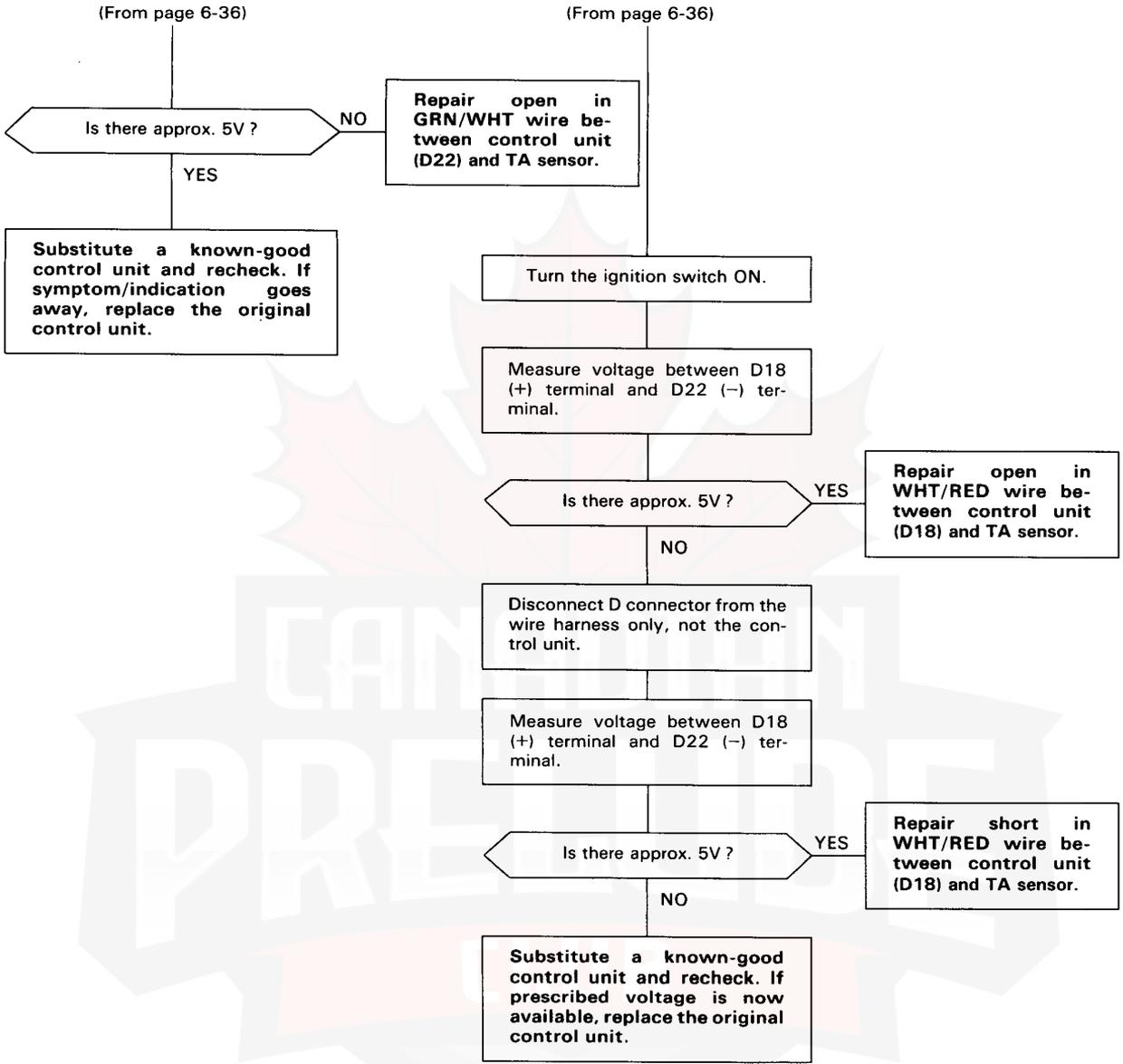

PGM-CARB Control System

Input Troubleshooting Flow Chart — Power Source (IG1, Bat) and Ground

Inspection of Power Source (IG1, Bat) and Ground.

Connect the ECU test harness between the control unit and connector (page 6-16).

Check for continuity between the body ground and the following terminals individually: •A24, •A26, •D19, •D21.

Does continuity exist?

NO

- Repair open in BRN/BLK wire between control unit (D19, D21) and G101.
- Repair open in BLK wire between control unit (A24, A26) and G101.

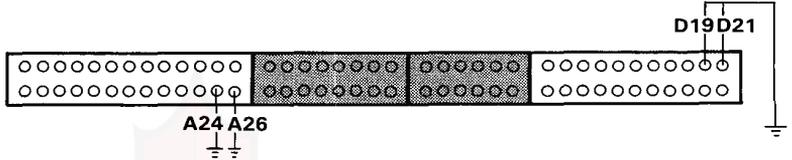

YES

Measure voltage between D1 (+) terminal and D21 (-) terminal.

Is there battery voltage?

NO

Inspect EFI, ECU fuse.

Is EFI, ECU fuse OK?

NO

Replace fuse.

Repair open in YEL/BLU wire between EFI, ECU fuse and control unit (D1).

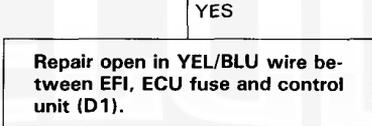

YES

Turn the ignition switch ON.

Measure voltage between A23 (+), A25 (+) terminal and D21 (-) terminal.

Is there battery voltage?

NO

Turn the ignition switch OFF.

Inspect No. 12 fuse.

Is No. 12 fuse OK?

NO

Replace fuse.

Repair open in BLK/YEL wire between No. 12 fuse and control unit (A23, A25).

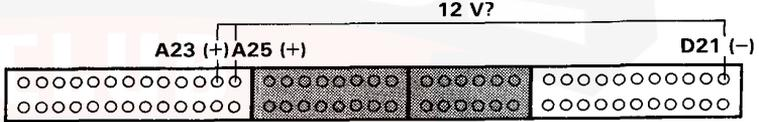

YES

Power Source (IG1, Bat) and Ground are OK.



PGM-CARB Control System

Input Troubleshooting Flowchart — Air Conditioning Signal

Inspection of Air Conditioning Signal.

Connect the ECU test harness between the control unit and connector (page 6-16). Disconnect "D" connector from the main wire harness only, not the control unit.

Turn the ignition switch ON.

Measure voltage between D6 (+) terminal and A26 (-) terminal.

Is there battery voltage ?

YES

Reconnect "D" connector to the main wire harness.

Connect A19 terminal to A26 terminal.

Does A/C operate ?

YES

Start engine.

Blower switch ON.

(To page 6-41)

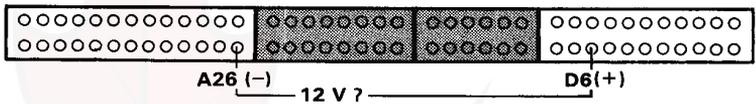

Substitute a known-good control unit and recheck. If prescribed voltage is now available, replace the original control unit.

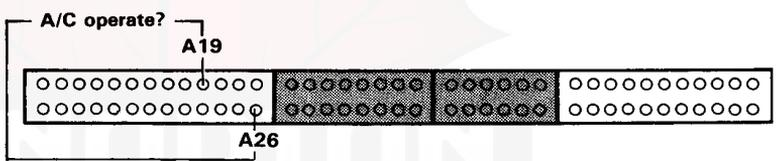

Connect the RED/BLU terminal of the 4P connector on the A/C clutch relay to body ground.

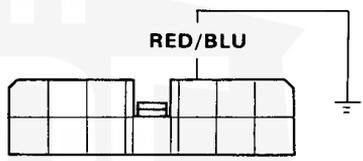

Does A/C operate ?

YES

Repair open in RED/BLU wire between ECU (A19) and compressor control unit.

NO

See Air conditioner inspection (section 15).

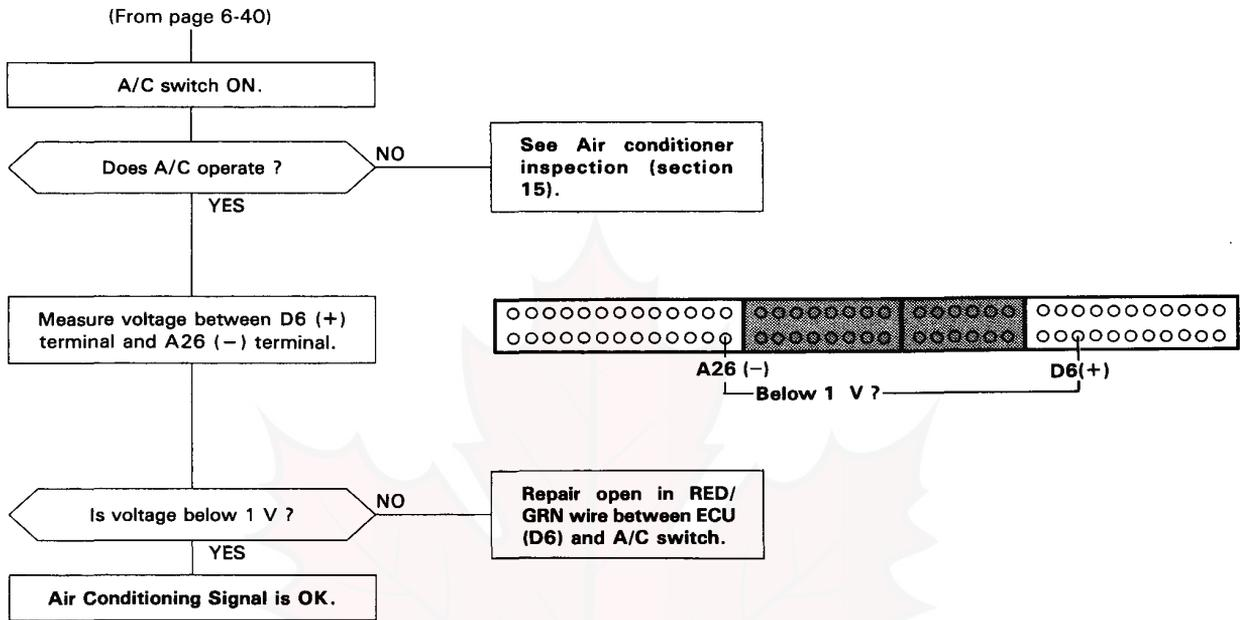

PGM-CARB Control System

Input Troubleshooting Flowchart — Clutch Switch Signal (M/T only)

Inspection of clutch switch signal

Turn the ignition switch OFF.

Connect the ECU test harness between the control unit and connector (page 6-16).

Turn the ignition switch ON.

Measure voltage between D8 (+) terminal and D21 (-) terminal.

Is there less than 1 V?

Depress the clutch pedal.

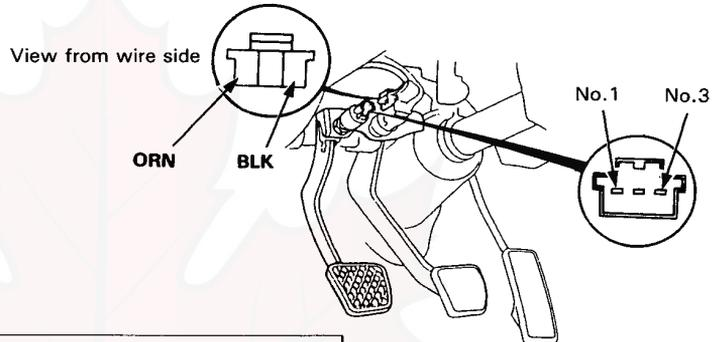
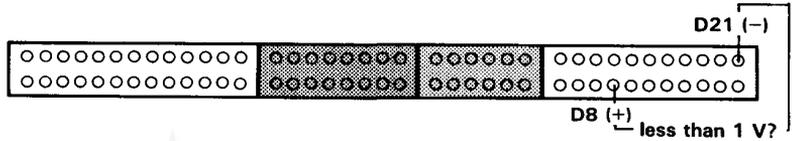

Turn the ignition switch OFF.

Disconnect the 3P connector on the clutch switch.

Connect ORN terminal to BLK terminal.

Turn the ignition switch ON.

Is there less than 1 V?

Replace clutch switch.

Repair open in ORN wire between ECU (D8) and clutch switch or BLK wire between clutch switch and G401.

(To page 6-43)



(From page 6-42)

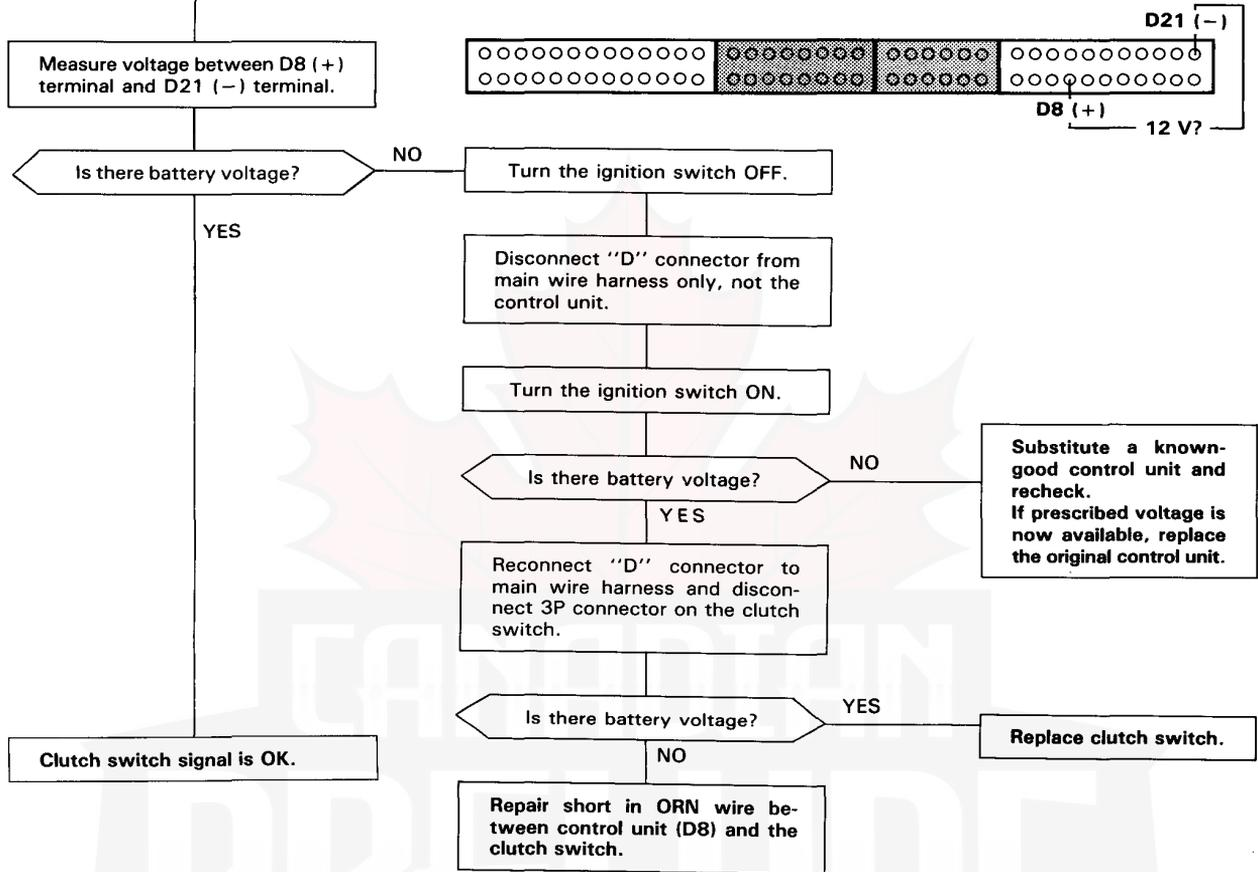

PGM-CARB Control System

Input Troubleshooting Flowchart — A/T Shift Position Signal (A/T only) —

Inspection of A/T shift position Signal.

Observe the A/T shift indicator and select each position separately.

Does the indicator light properly?

NO

See A/T shift position Indicator Inspection (section 16).

YES

Warm up engine to normal operating temperature (the cooling fan comes on).

Turn the ignition switch OFF.

Connect the ECU test harness between the control unit and connector (page 6-16).

Measure voltage between D10 (+) terminal and D21 (-) terminal in Neutral and Park position.

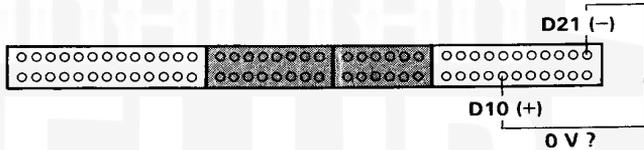

Is there voltage?

YES

Repair open in LT GRN wire between control unit (D10) and combination meter.

NO

(To page 6-45)



(From page 6-44)

Measure voltage between D10 (+) terminal and B8 (-) terminal in all other shift positions except Neutral and Park.

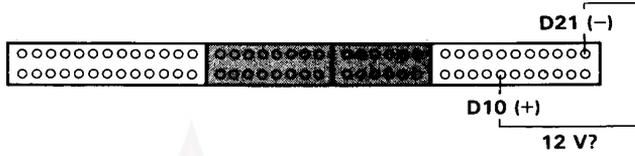

Is there battery voltage?

NO

Repair short in LT GRN wire between combination meter and control unit (D10).

YES

A/T shift Position Switch Signal is OK.

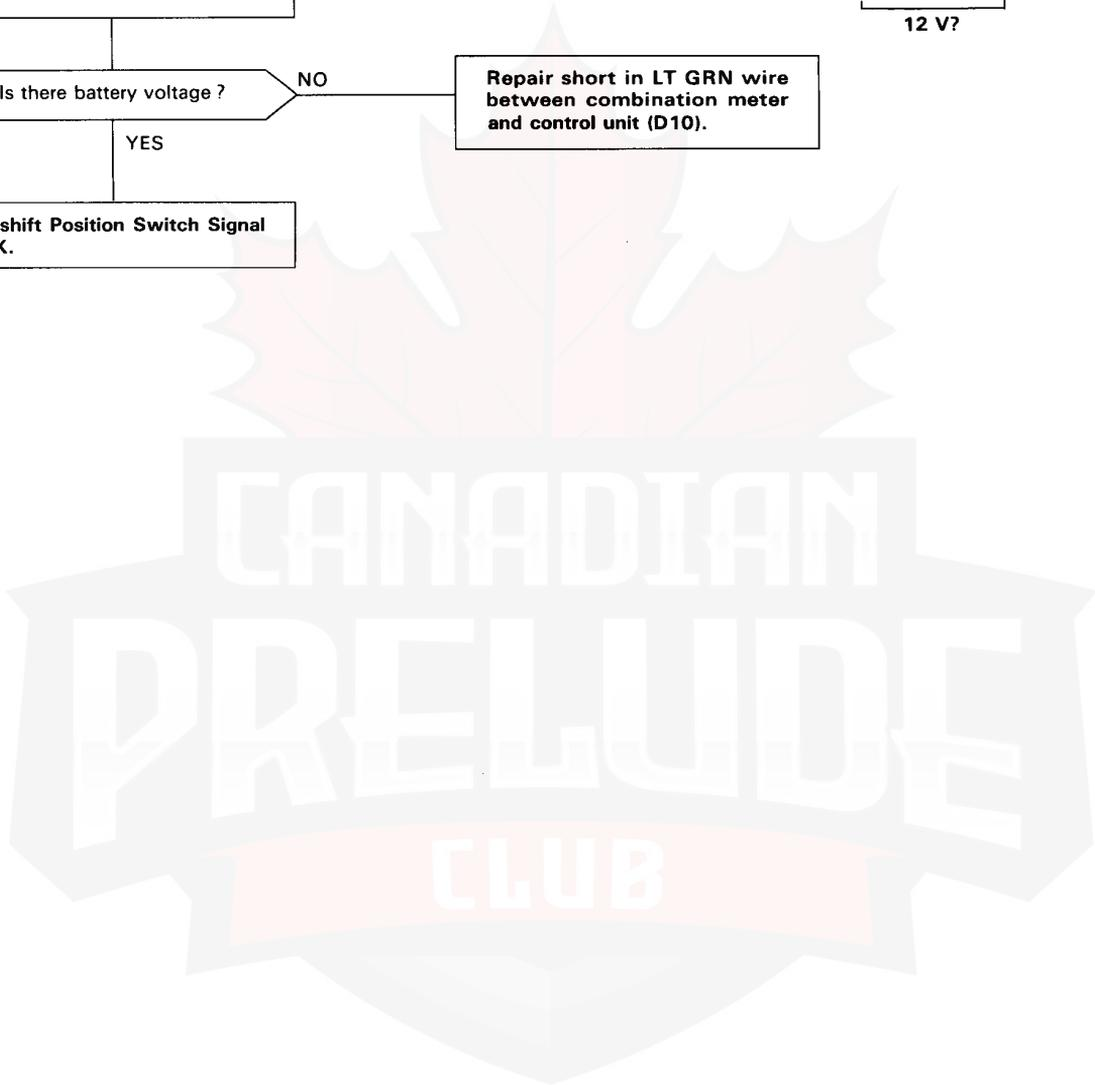

PGM-CARB Control System

Input Troubleshooting Flow Chart — P/S Oil Pressure Switch Signal (4WS) —

Inspection of P/S Oil Pressure Switch Signal.

Connect the ECU test harness between the control unit and connector (page 6-16).

Turn the ignition switch ON.

Measure voltage between D11 (+) terminal and D21 (-) terminal.

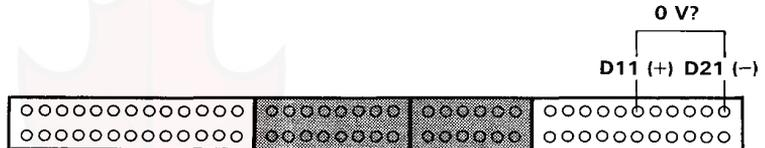

Is there voltage?

YES — Turn the ignition switch OFF.

NO — Disconnect the 2P connector on the P/S oil pressure switch.

Connect BLU/RED terminal to BLK terminal.

Turn the ignition switch ON.

Is there voltage?

NO — Replace the P/S oil pressure switch.

- YES
- Repair open in BLU/RED wire between control unit (D11) and P/S oil pressure switch.
 - Repair open in BLK wire between P/S oil pressure switch and G301.

Turn steering wheel slowly.

(To page 6-47)

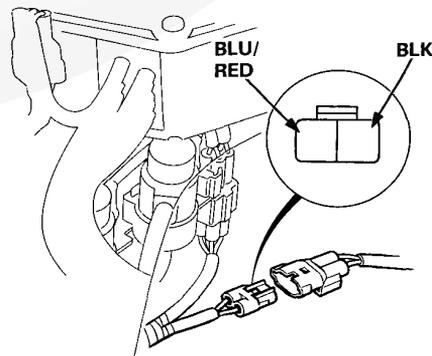



(From page 6-46)

Measure voltage between D11 (+) terminal and D21 (-) terminal while steering wheel is turning.

12 V?
D11 (+) D21 (-)

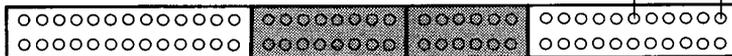

Is there battery voltage?

NO

Turn the ignition switch OFF.

Disconnect the 2P connector on the P/S oil pressure switch.

Check for continuity between the 2 terminals on the P/S oil pressure switch.

Does continuity exist?

YES

Replace the P/S oil pressure switch.

NO

- Repair short in BLU/RED wire between control unit (D11) and P/S oil pressure switch.
- Substitute a known-good control unit and recheck. If prescribed voltage is now available, replace the original control unit.

P/S Oil Pressure Switch Signal is OK.

Carburetor

Symptom-to-Sub System Chart

NOTE:

- Across each row in the chart, the sub systems that could be sources of a symptom are ranked in the order they should be inspected, starting with ①. Find the symptom in the left column, read across to the most likely source, then refer to the page listed at the top of that column. If inspection shows the system is OK, try the next system ②, etc.
- Before starting inspection, check that other items that affect engine performance are within specification. Check the warning light and the self-diagnosis indicator, valve clearance, air cleaner, and PCV valve. In addition, check the ignition timing, function of the vacuum and centrifugal advance, and the condition of the spark plugs. If those items are all within specifications, begin with the troubleshooting listed below and on page 6-49.

PAGE	SYSTEM	CARBURETOR			
		IDLE SPEED/ MIXTURE	IDLE BOOST (4WS) A/C IDLE BOOST	AUTOMATIC CHOKE/ FAST IDLE SYSTEM	AIR VENT CUT-OFF (INNER VENT) SOLENOID VALVE
		71	50	—	98, 100
ENGINE WON'T START					①
DIFFICULT TO START ENGINE	WHEN COLD			①	②
	WHEN WARM				②
IRREGULAR IDLING	WHEN COLD FAST IDLE OUT OF SPECIFICATION			①	
	WHEN WARM ENGINE SPEED TOO HIGH	①	②	③	
	WHEN WARM ENGINE SPEED TOO LOW	①	②		
	ROUGH IDLE/ FLUCTUATION	①	③		②
FREQUENT STALLING	WHILE WARMING UP	③		①	
	AFTER WARMING UP	①	③		③
POOR PERFORMANCE	MISFIRE OR ROUGH RUNNING	③		③	①
	LOSS OFF POWER				②
	AFTERBURN	②			
	HESITATION/SURGE				



CARBURETOR

POWER VALVE	PRIMARY SLOW MIXTURE CUT-OFF SOLENOID VALVE	SLOW AIR JET CONTROL	VACUUM PISTON CONTROL	ACCELERATOR PUMP
77	66	64	68	—
③	②			
	③			
	①	③		
	②			
		③		
		③		
	②			
	②	③		
			②	
③			①	③
	①			
				①

Carburetor

Idle Control System

Testing

Idle speed too high in no-load conditions

1. Start the engine and warm up to normal operating temperature (the cooling fan comes on).
2. Disconnect the vacuum hose (4WS: two vacuum hoses) from the idle boost throttle controller and check for vacuum.

There should be no vacuum (4WS: in both hose).

Except 4WS:

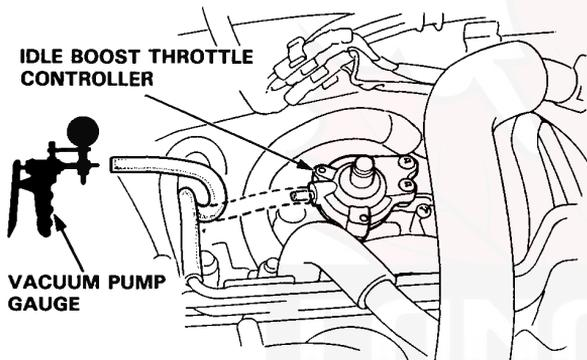

4WS:

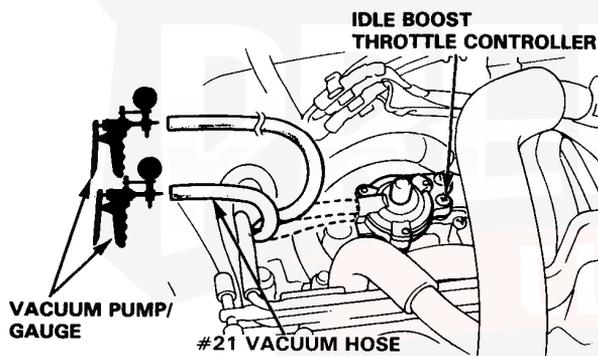

- If there is no vacuum, check the throttle valve shaft for binding or sticking, and replace the idle boost throttle controller.
- Except 4WS: If there is vacuum, go to troubleshooting (page 6-57, 59).

4WS: If there is vacuum at either hose, go to troubleshooting (#21 hose: page 6-52, 54, outside hose: page 6-57, 59).

Idle speed is rough while the steering wheel is turning (4WS)

1. KX, KS, KZ model: Check the idle speed is above specified in no-load conditions, when the 2P connector on the P/S oil pressure switch is disconnected.

Except KX, KS, KZ model: Disconnect the 2P connector on the P/S oil pressure switch, and connect a jumper wire between the 2 terminals on the wire harness. Then check the idle speed is above specified in no-load conditions.

- If idle speed is as specified in no-load conditions, disconnect the #21 vacuum hose from the idle boost throttle controller and check for vacuum.

There should be vacuum.

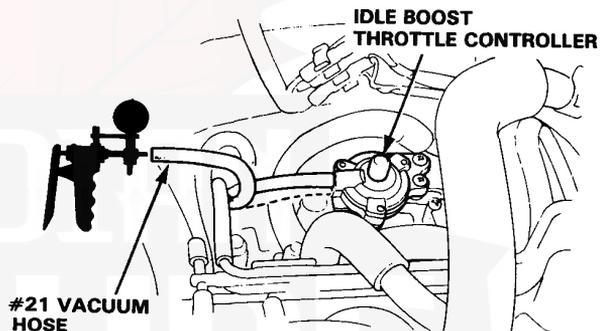

- If there is vacuum, check the throttle valve shaft for binding or sticking, and replace the idle boost throttle controller.
- If there is no vacuum, check the vacuum hose for proper connection, cracks, blockage or disconnected hose. If OK, go to troubleshooting (KX, KS, KZ model: page 6-52, Except KX, KS, KZ model: page 6-54).



Idle speed is low with A/C on

1. Disconnect the two vacuum hoses from the idle boost throttle controller and check for vacuum with the A/C on.

There should be vacuum (4WS: in both hoses).

Except 4WS:

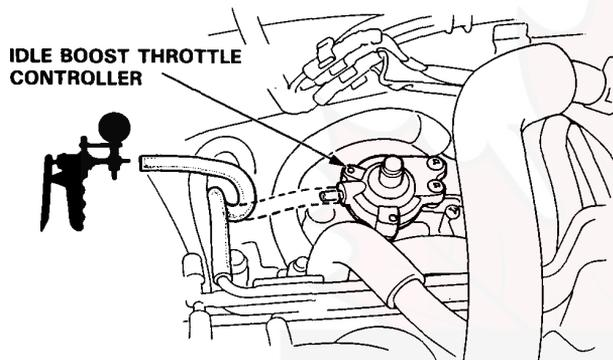

4WS:

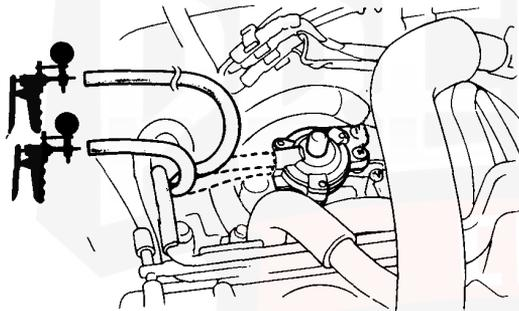

- If there is vacuum, replace the idle boost throttle controller and recheck.
- 4WS: If there is no vacuum only at the #21 hose, go to troubleshooting (page 6-52, 54).
- If there is no vacuum (4WS: only at the outside hose), go to troubleshooting (page 6-57, 59).

(cont'd)

Carburetor

Idle Control System

[KX, KS, KZ model (4WS)]

Troubleshooting Flow Chart Idle Boost Solenoid Valve

Inspection of Idle Boost Solenoid Valve

Start the engine and warm up to normal operating temperature (the cooling fan comes on).

Disconnect the lower vacuum hose of the solenoid valve from the joint and connect a vacuum pump.

Disconnect the #21 vacuum hose from the vacuum hose manifold, and connect a vacuum gauge.

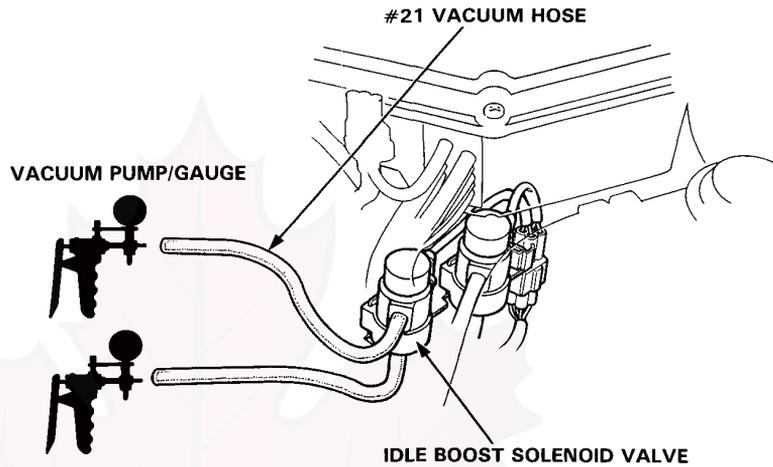

Is there vacuum?

YES

Turn the ignition switch OFF.

NO

Disconnect the 4P connector.

Turn the ignition switch OFF.

Start the engine.

Measure voltage between BRN (+) terminal and BLK (-) terminal.

Disconnect the 2P connector on the P/S oil pressure switch.

Is there voltage?

NO

Replace the solenoid valve.

YES

Check the self-diagnosis indicator. If OK, check the input troubleshooting (page 6-18).

Turn the ignition switch ON.

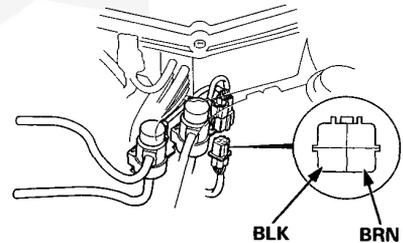

(To page 6-53)

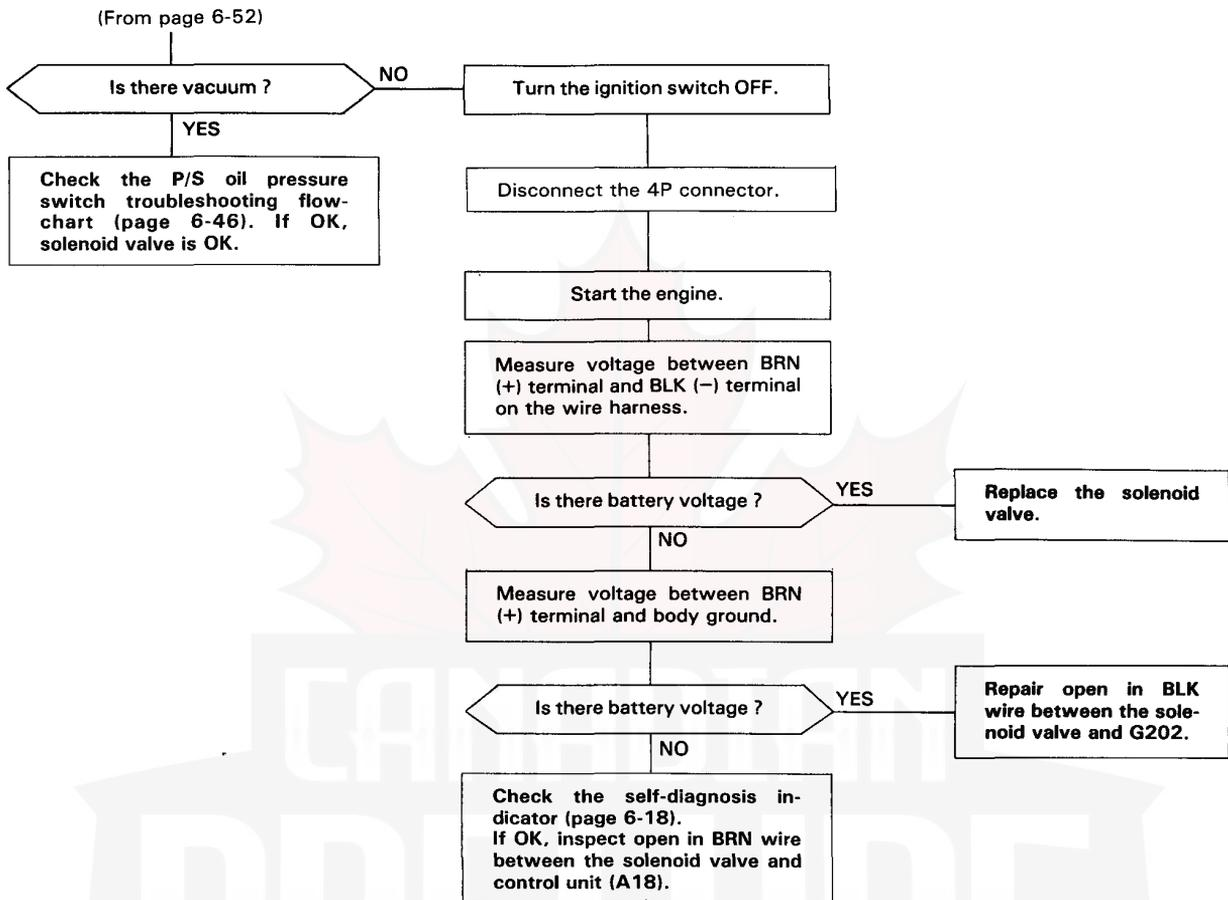

(cont'd)

Carburetor

Idle Control System (cont'd)

[Except KX, KS, KZ model (4WS)]

Troubleshooting Flowchart Idle Boost Solenoid Valve

Inspection of Idle Boost Solenoid Valve.

Disconnect the lower vacuum hose of the solenoid valve from the joint and connect a vacuum pump.

Disconnect #21 vacuum hose of the solenoid valve from the vacuum hose manifold and connect a vacuum gauge.

Start the engine.

Apply vacuum.

Is vacuum indicated on the gauge?

YES

Turn the ignition switch OFF.

Disconnect the connector on the solenoid valve.

Turn the ignition switch ON.

Measure voltage between BRN (+) terminal and BLK (-) terminal on the solenoid valve.

Is there voltage?

NO

Replace the solenoid valve.

YES

- Replace the P/S oil pressure switch.
- Repair the idle boost relay and see air conditioner inspection (section 15).

Turn steering wheel slowly.

Apply vacuum.

(To page 6-55)

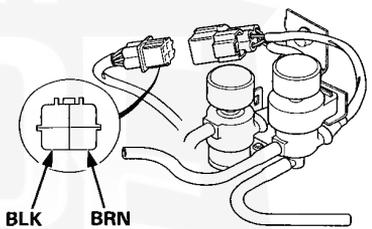
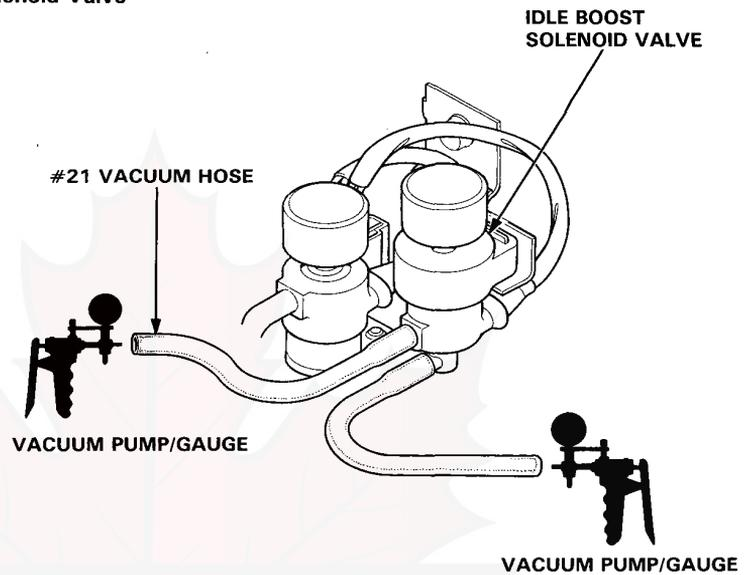



(From page 6-54)

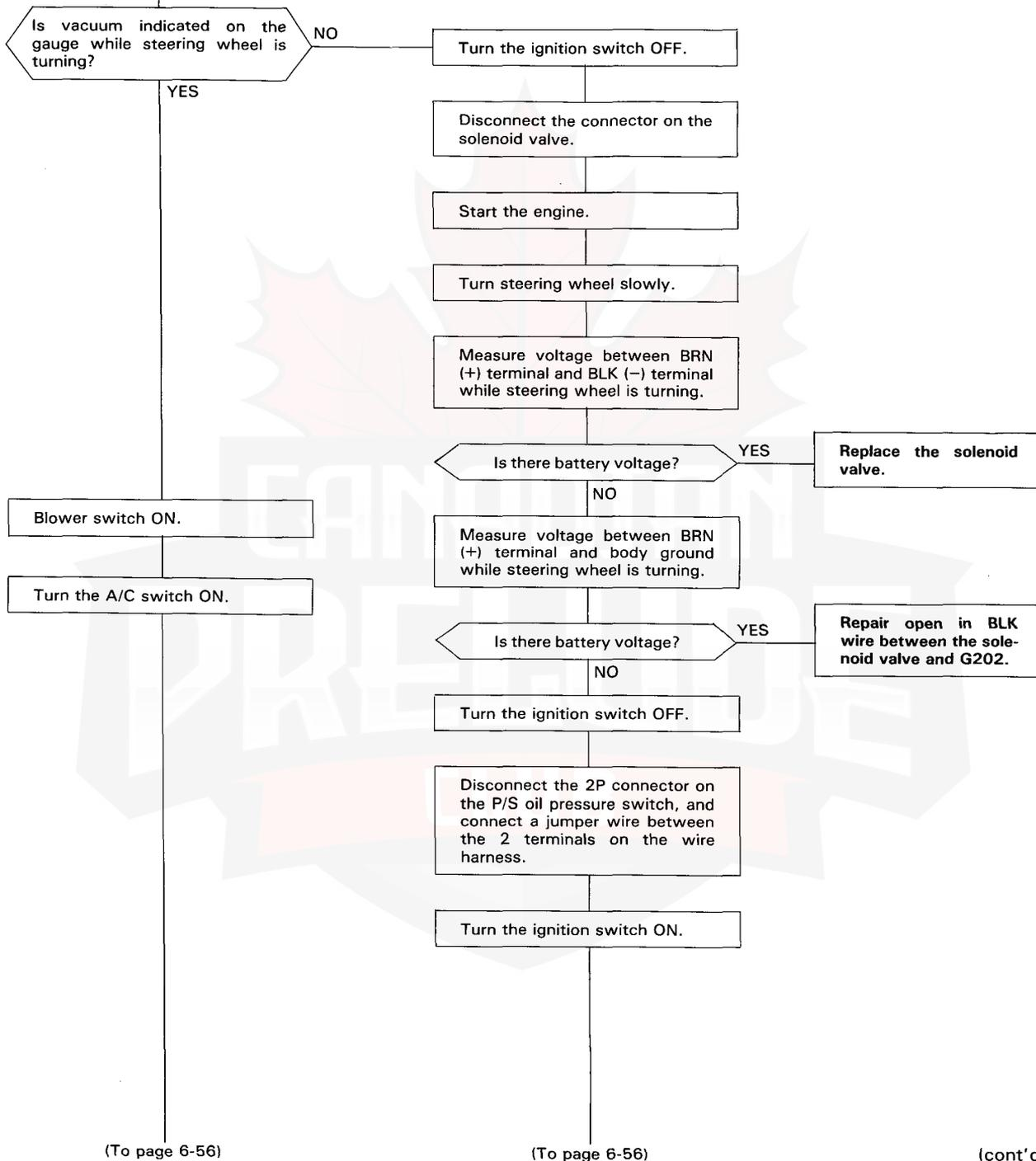

Carburetor

Idle Control System (cont'd)

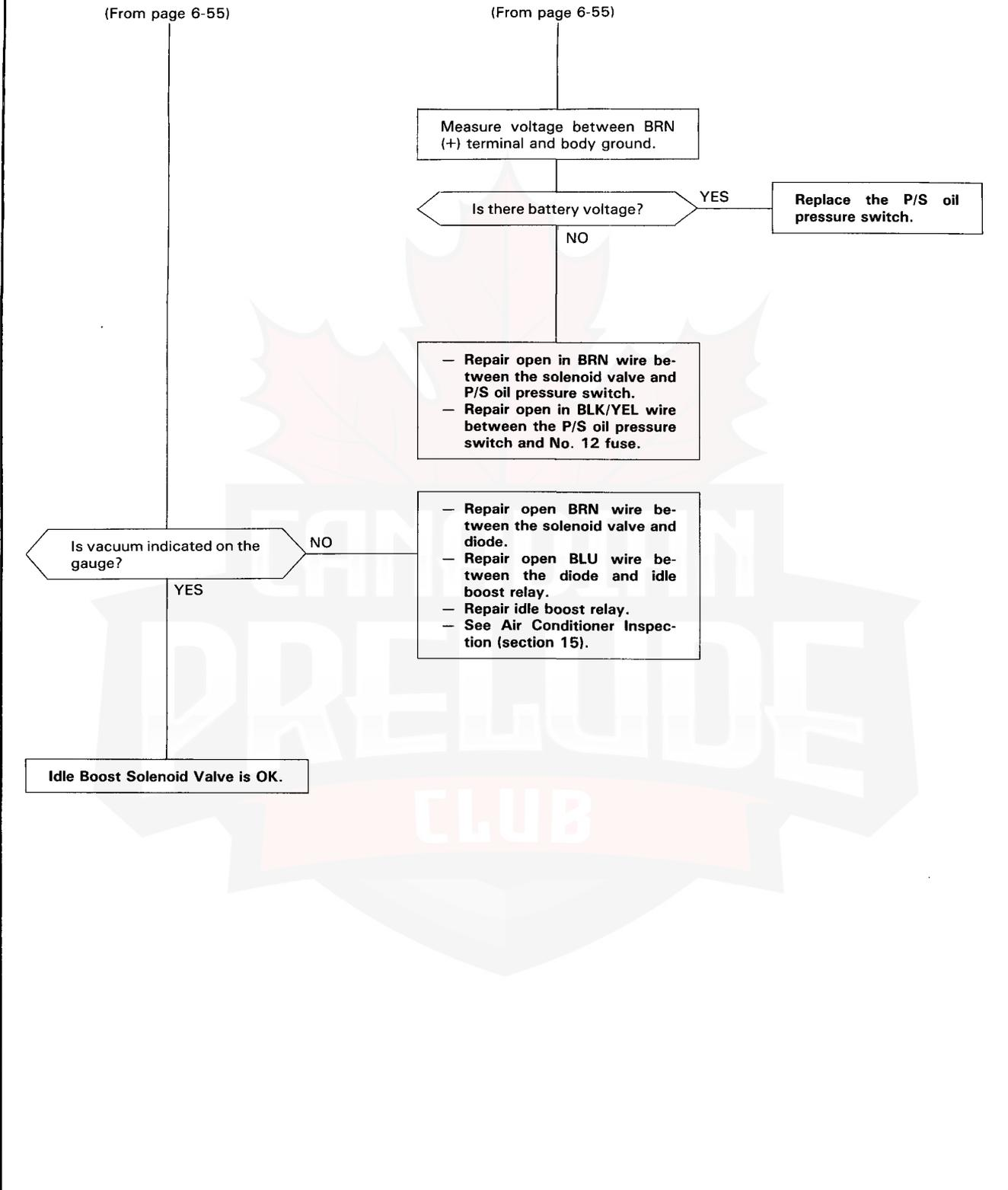



[KX, KS, KZ model (A/C)]

Troubleshooting Flowchart A/C Idle Boost System

Inspection of A/C Idle Boost System

Disconnect the upper vacuum hose of the solenoid valve from the idle boost throttle controller and connect a vacuum gauge.

Start the engine.

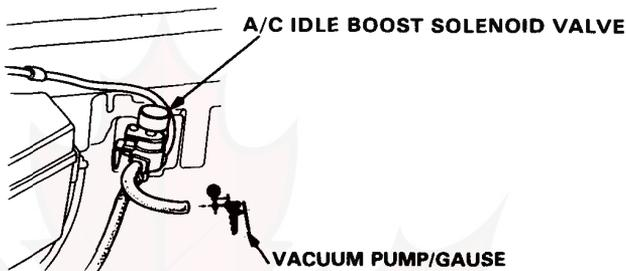

Is there vacuum ?

YES
Disconnect the 2P connector near the solenoid valve.

Is there vacuum ? YES
Replace the solenoid valve.

NO

NO

Turn the A/C switch ON.

Inspect the A/C signal (page 6-40).

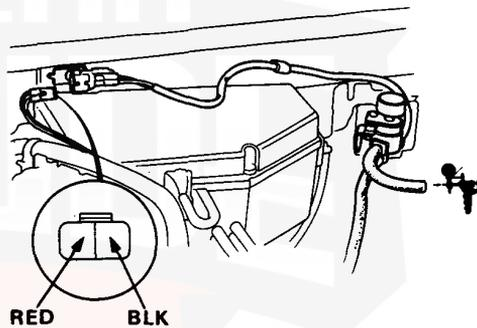

Is there vacuum ?

NO
Disconnect the 2P connector near the solenoid valve.

YES

A/C Idle Boost solenoid valve and A/C signal are OK.

Measure voltage between RED (+) terminal and BLK (-) terminal on the wire harness.

Measure voltage between RED (+) terminal and body ground.

NO
Is there battery voltage ?

YES

Disconnect the lower vacuum hose from the solenoid valve and connect a vacuum gauge to the disconnected hose.

(To page 6-58)

(To page 6-58)

(cont'd)

Carburetor

Idle Control System (cont'd)

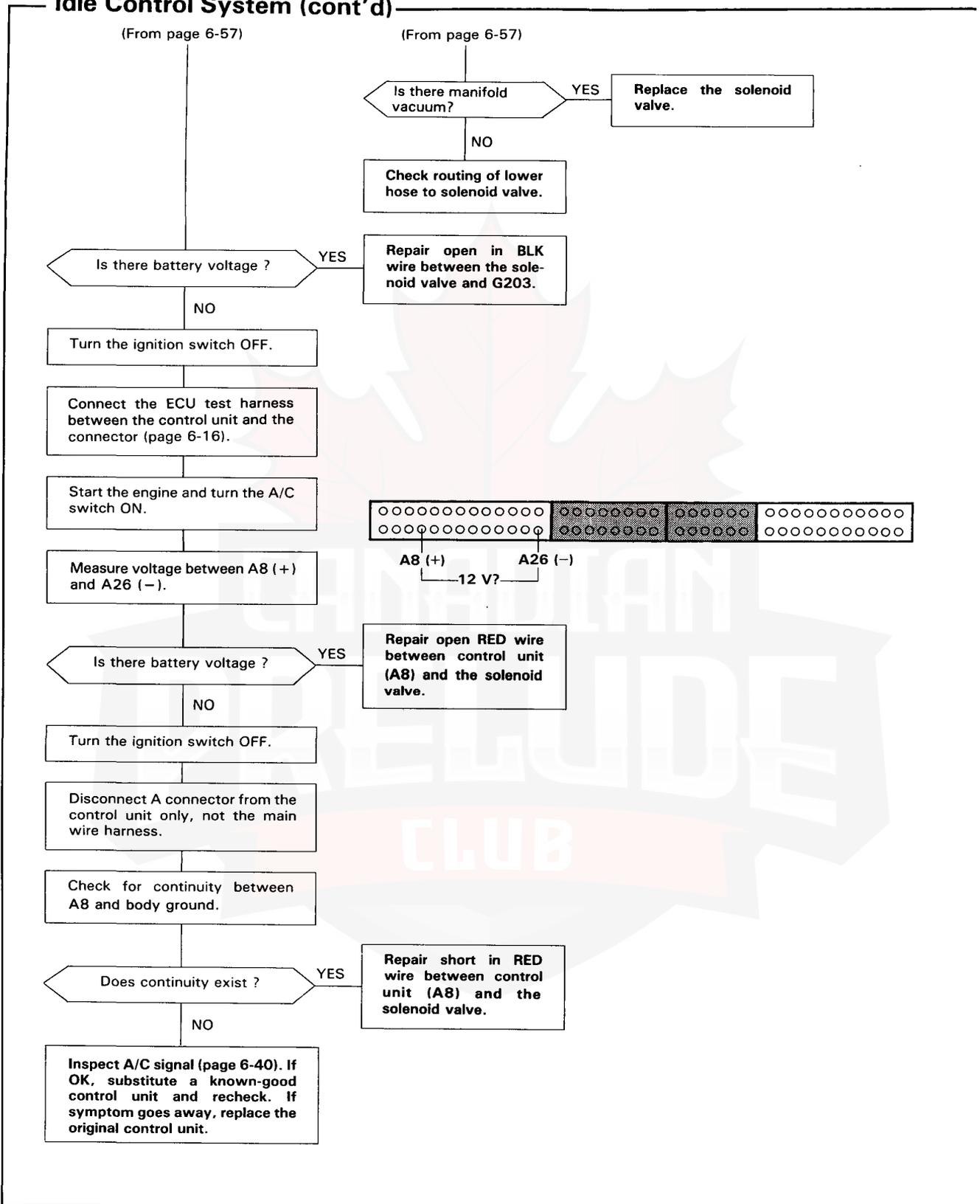



[Except KX, KS, KZ model (A/C)]
Troubleshooting Flow Chart A/C Idle Boost Solenoid Valve

Inspection of A/C Idle Boost System

Disconnect the upper vacuum hose of the solenoid valve from the idle boost throttle controller and connect a vacuum gauge.

Start the engine and warm up to normal operating temperature (the cooling fan comes on).

Is there vacuum ?

YES
 Disconnect the 2P connector near the solenoid valve.

NO

Turn the blower switch ON.

Is there vacuum ?

YES
 Replace the solenoid valve.

NO

Turn the A/C switch ON.

Inspect the A/C signal.

Is there vacuum ?

NO
 Disconnect the 2P connector near the solenoid valve.

YES

A/C Idle Boost solenoid valve and A/C signal are OK.

Measure voltage between RED (4WS: BLU) (+) terminal and BLK (-) terminal on the wire harness.

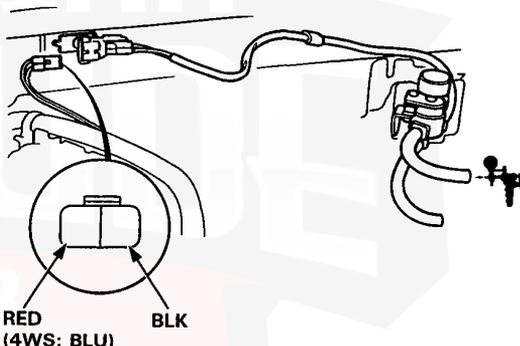

Measure voltage between RED (4WS: BLU) (+) terminal and body ground.

NO
 Is there battery voltage ?

YES

Disconnect the lower vacuum hose from the solenoid valve and connect a vacuum gauge to the disconnected hose.

(To page 6-60)

(To page 6-60)

(cont'd)

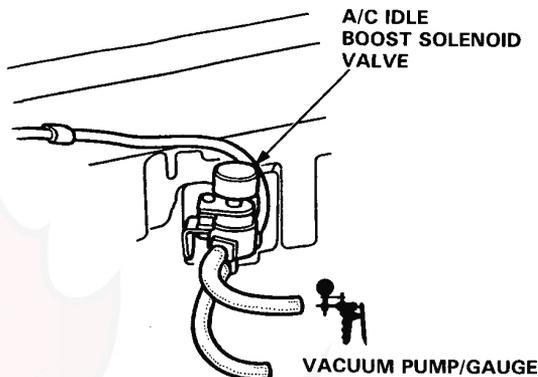

Carburetor

Idle Control System (cont'd)

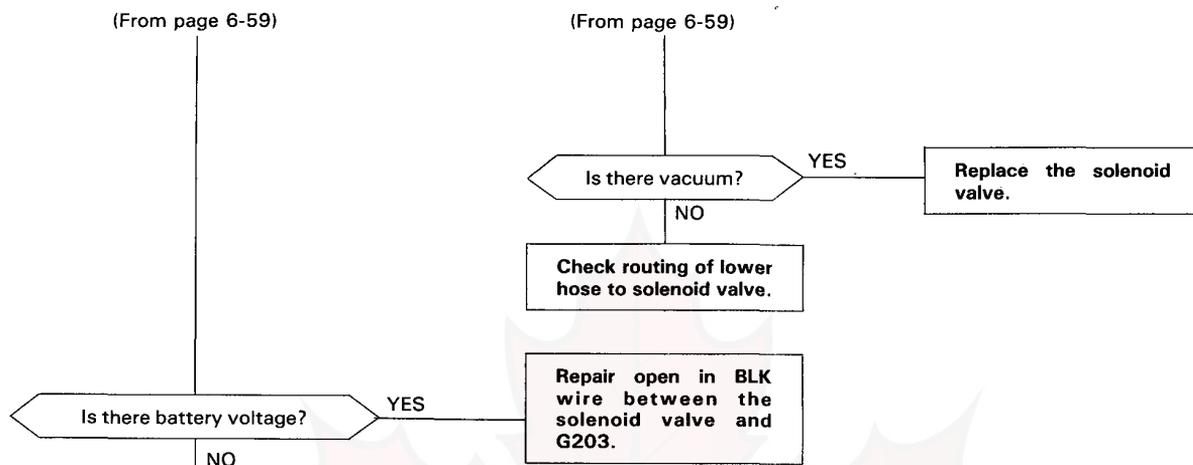

Except 4WS:
Repair open in RED wire between the solenoid valve and compressor control unit.

4WS:
Repair open in BLU wire between the solenoid valve and idle boost relay. If OK, repair the idle boost relay.
See Air Conditioner inspection (section 15).



[KX, KS, KZ model]

Idle Boost Throttle Controller Testing

1. Start the engine and warm up to normal operating temperature (the cooling fan comes on).
2. Connect a tachometer.
3. Disconnect the vacuum hose from the idle boost throttle controller and connect a vacuum pump to the controller, then apply vacuum.

Except 4WS:

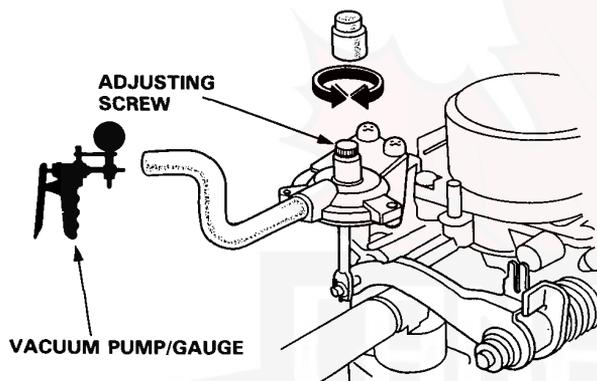

4WS:

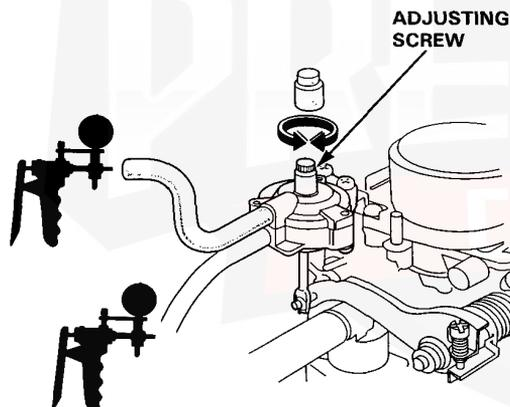

4. Check the engine speed.

Engine speed should be: $1,200 \pm 50 \text{ min}^{-1}$ (rpm)
Adjust the engine speed, if necessary, by turning the adjusting screw.

(cont'd)

Carburetor

Idle Control System (cont'd)

[KX, KS, KZ model]

Troubleshooting Flowchart A/C Idle Boost Solenoid Valve

Inspection of A/C Idle Boost Solenoid Valve.

Warm up engine to normal operating temperature (cooling fan comes on).

Disconnect the upper vacuum hose of the solenoid valve from the idle boost throttle controller and connect a vacuum gauge.

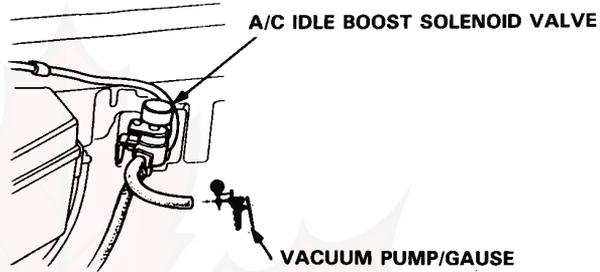

Is there any vacuum?

YES

Disconnect the 2P connector near the solenoid valve.

NO

Turn the ignition switch OFF.

Is there any vacuum?

YES

Replace the A/C idle boost solenoid valve.

NO

Disconnect the 2P connector from the solenoid valve.

Check the self-diagnosis indicator (page 6-18).
If OK, substitute a known-good control unit and retest. If symptom goes away, replace the original control unit.

Connect battery positive to terminal A and battery negative to terminal B of the connector.

Start the engine.

(To page 6-63)

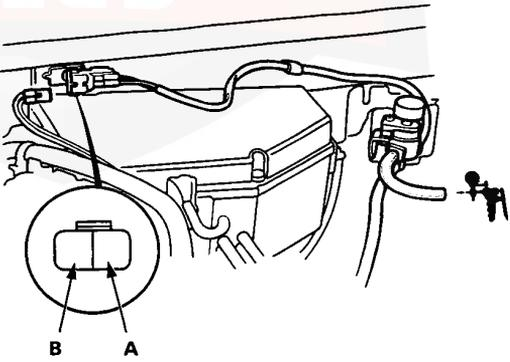



(From page 6-62)

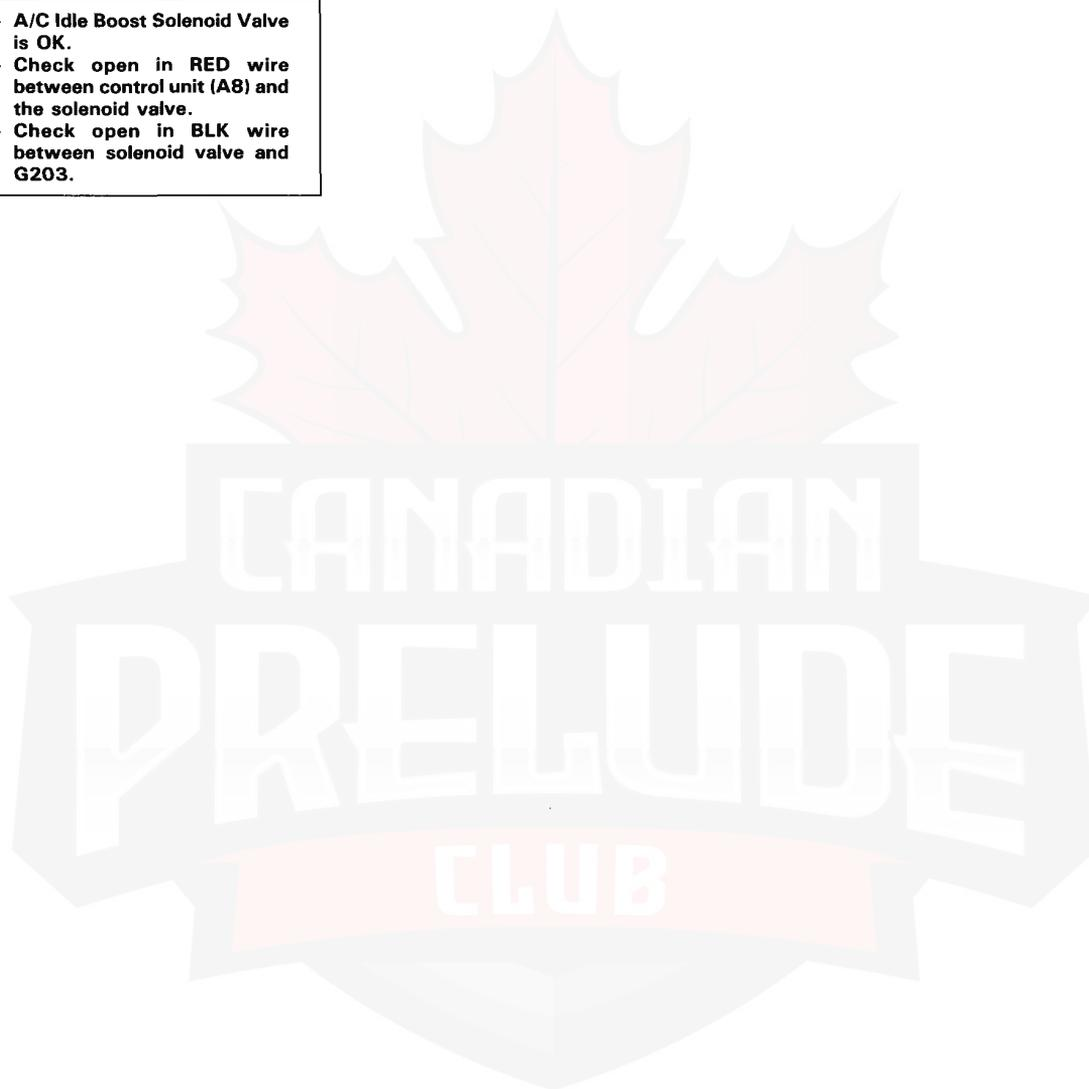
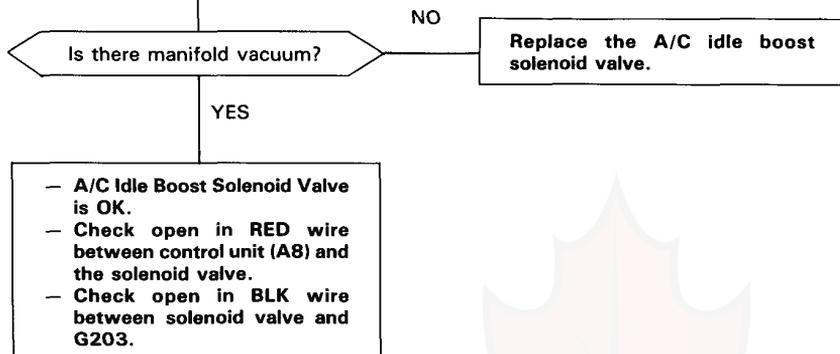

Carburetor

Slow Air Jet Control System

[KX, KS, KZ model]

Troubleshooting Flowchart Air Leak Solenoid Valve

Inspection of Air Leak Solenoid Valve

Remove the air cleaner cover and filter element.

Disconnect the vacuum hose and connect a vacuum pump.

NOTE: Intake air temperature must be below 63°C (145°F).

Start the engine.

Apply 100 mmHg (4 in.Hg) vacuum to the hose.

Does solenoid valve hold vacuum?

NO

Turn the ignition switch OFF.

Disconnect the GRN connector near the air cleaner.

Start the engine.

Measure voltage between GRN (+) and body ground.

Is there battery voltage?

NO

YES

Replace the solenoid valve.

Warm up the engine.

NOTE: If the intake air temperature is below 70°C (158°F), warm the TA sensor with a dryer.

(To page 6-65)

AIR LEAK SOLENOID VALVE

VACUUM PUMP/GAUGE

GRN

Check the self-diagnosis indicator (page 6-18). If OK, repair open in GRN wire between the solenoid valve and control unit (A12).



(From page 6-64)

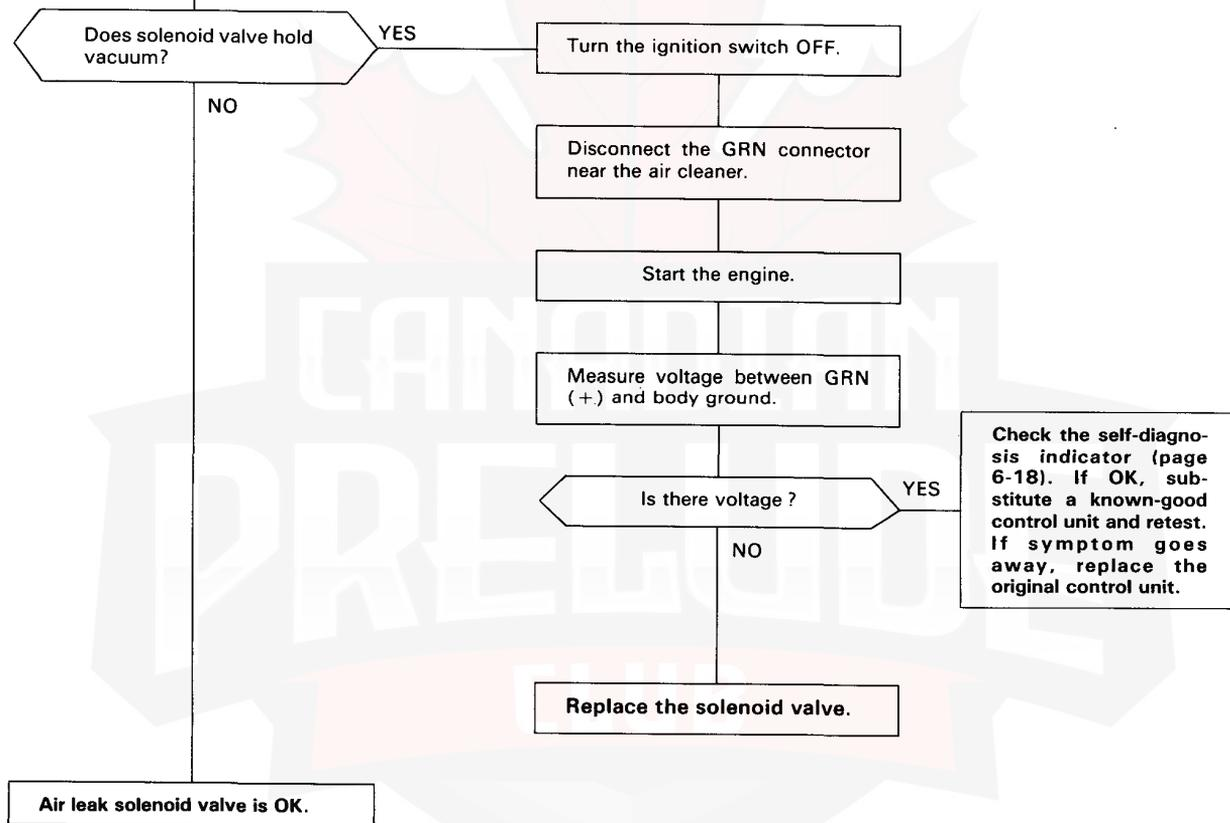

Carburetor

Primary Slow Mixture Cut-off Solenoid Valve

[KX, KS, KZ model]

Troubleshooting Flowchart Primary Slow Mixture Cut-off Solenoid Valve

Inspection of Primary Slow Mixture Cut-off Solenoid Valve

Turn the ignition switch ON.

Check the clicking sound of each solenoid valve by means of a stethoscope.

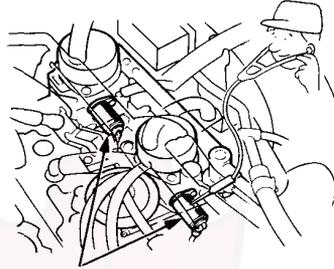

PRIMARY SLOW MIXTURE CUT-OFF SOLENOID VALVE

Does the solenoid valve click?

NO

Turn the ignition switch OFF.

YES

Connect the ECU test harness between the control unit and connector (page 6-16).

Turn the ignition switch ON.

Start the engine and warm up to normal operating temperature (the cooling fan comes on).

Measure voltage between A21 (+) terminal and A26 (-) terminal.

Is there battery voltage?

YES

Repair open or short in BLK/YEL wire between the solenoid valve and control unit (A21).

If OK:
right solenoid valve: replace the solenoid valve.

left solenoid valve: inspect open in BLK wire between the solenoid valve and G151, and replace the solenoid valve.

NO

WARNING Block rear wheels before jacking up front of car.

Block rear wheels and set the parking brake. Jack up the front of the car and support with safety stands.

Check the self-diagnosis indicator (page 6-18). If OK, substitute a known-good control unit and retest. If symptom goes away, replace the original control unit.

Place the transmission in second or "2" and accelerate, then suddenly release the throttle.

(To page 6-67)

12V?

A21 (+)



A26 (-)



(From page 6-66)

Check for the clicking sound of each solenoid valve by means of a stethoscope during deceleration above 20 km/h and 4,000 min⁻¹ (rpm).

Does the solenoid valve click?

NO

Turn the ignition switch OFF.

Connect the ECU test harness between the control unit and connector (page 6-16)

Start the engine.

Measure voltage between A21 (+) terminal and A26 (-) terminal during deceleration above 20 km/h and 4,000 min⁻¹ (rpm).

Is there no voltage for a moment?

NO

Check the self-diagnosis indicator (page 6-18).
If OK, substitute a known-good control unit and retest. If symptom goes away, replace the original control unit.

YES

Replace the solenoid valve.

Solenoid valve is OK.

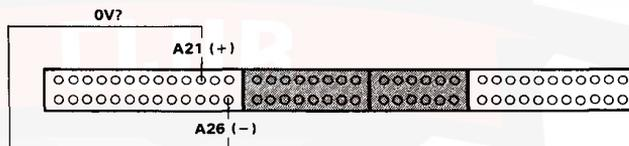

Carburetor

Vacuum Piston Control System

[KX, KS, KZ model]

Testing

1. Disconnect the vacuum hose from the carburetor and connect a vacuum pump. Apply vacuum.

There should be a restricted vacuum leak.

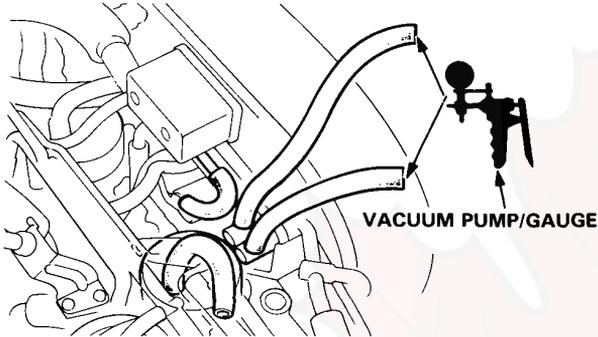

- If it does not hold vacuum at all, check the vacuum hose for proper connection, cracks, blockage or disconnected hose, then, if necessary, replace the vacuum piston control valve.

2. Start the engine and warm up to normal operating temperature (the cooling fan comes on).
3. Check for vacuum.

It should not hold vacuum.

- If it holds vacuum, check the vacuum hose for proper connection or blockage, and go to step 4.
- If it does not hold vacuum, go to step 5.

4. Disconnect the #28 vacuum hose from the air cleaner and connect a vacuum pump.

There should be vacuum.

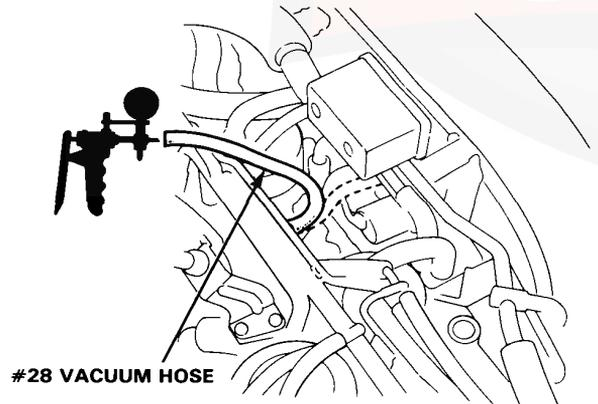

- If there is vacuum, replace the vacuum piston control valve.
- If there is no vacuum, go to troubleshooting (page 6-69).

5. Disconnect the #28 vacuum hose from the air cleaner and connect a vacuum pump. Quickly raise engine speed to 3,000 min⁻¹ (rpm) and close the throttle suddenly, then check vacuum.

There should be no vacuum for a moment.

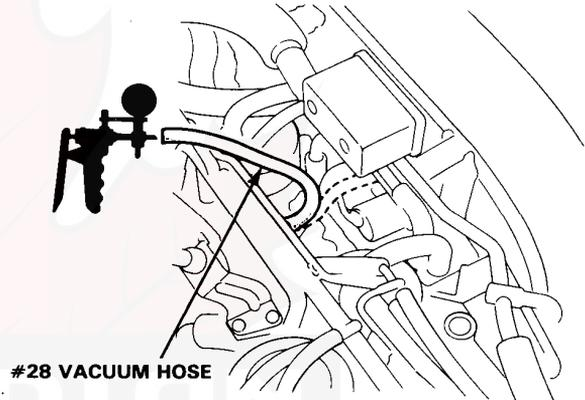

- If vacuum did not drop momentarily, go to troubleshooting (page 6-69).



Troubleshooting Flowchart Vacuum Piston Control Solenoid Valve

Inspection of Vacuum Piston Control Solenoid Valve

Remove the control box and open the control box lid.

Disconnect the lower vacuum hose of the solenoid valve from the 3-way joint and connect a vacuum pump.

Disconnect the #28 vacuum hose of the solenoid valve from the vacuum hose manifold and connect a vacuum gauge.

Start the engine and warm up to normal operating temperature (the cooling fan comes on).

Apply vacuum.

Is vacuum indicated on the gauge?

YES

(To page 6-70)

NO

Turn the ignition switch OFF.

Disconnect the 8P connector on the control box.

Start the engine.

Measure voltage between YEL (+) terminal and BLK (-) terminal on the wire harness.

Is there battery voltage?

NO

(To page 6-70)

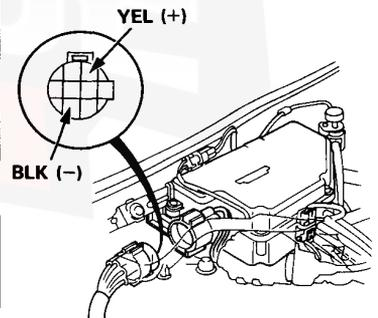
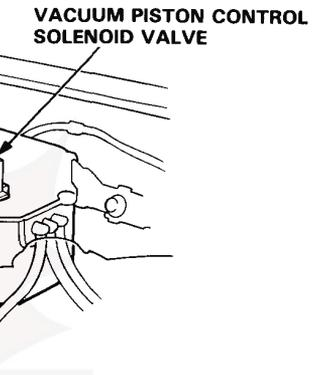

Replace the solenoid valve.

(cont'd)

Carburetor

Vacuum Piston Control System (cont'd)

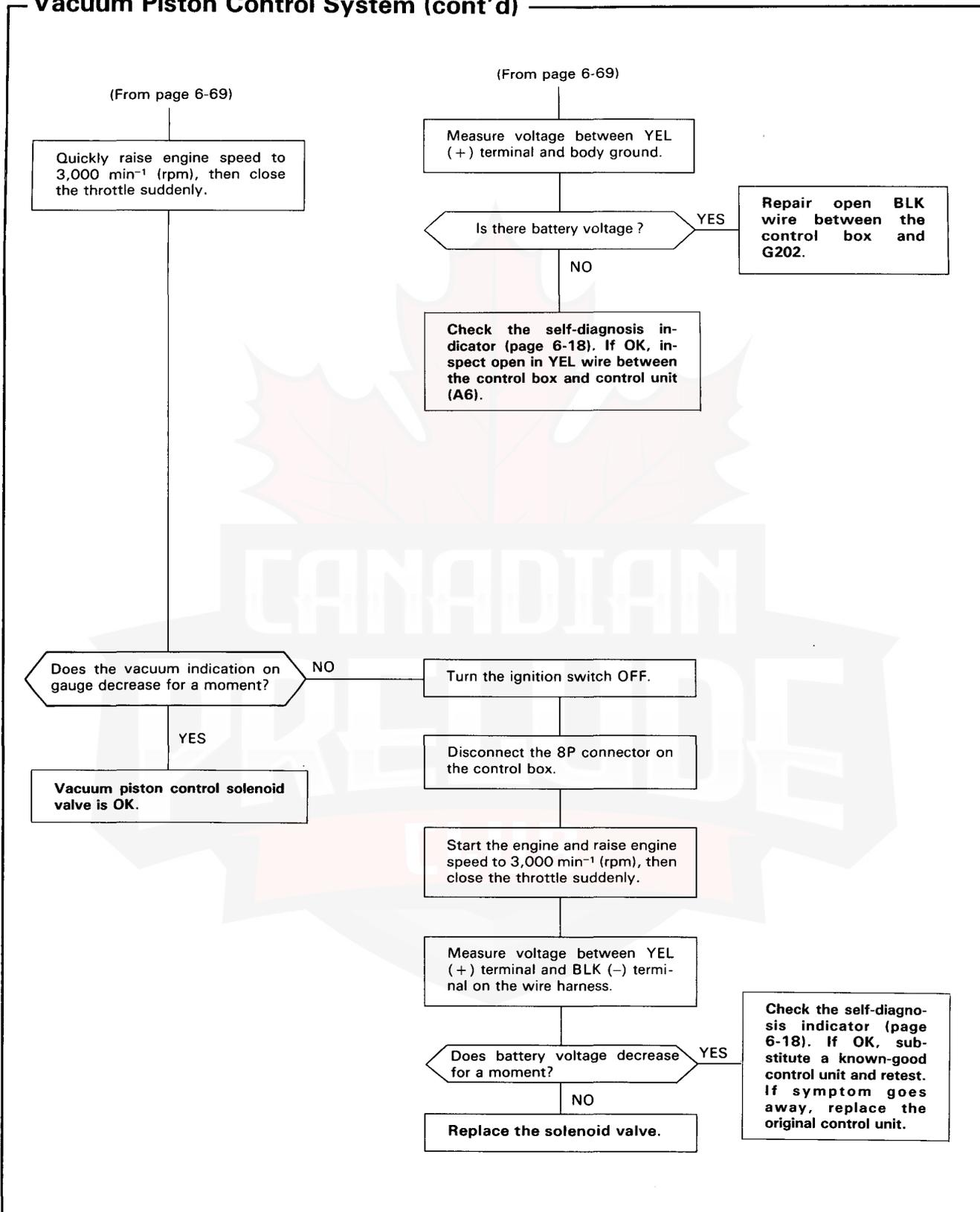



Idle Speed/Mixture

[KS model]

Inspection/Adjustment

Propane Enrichment Method

⚠ WARNING Do not smoke during this procedure. Keep any open flame away from your work area.

NOTE:

- This procedure requires a propane enrichment kit.
- Check that the carburetors are synchronized properly, self diagnosis indicator before making idle speed and mixture inspections.

1. Start the engine and warm up to normal operating temperature (the cooling fan comes on).
2. Disconnect the #8 vacuum hose from the intake air control diaphragm and clamp the hose end.

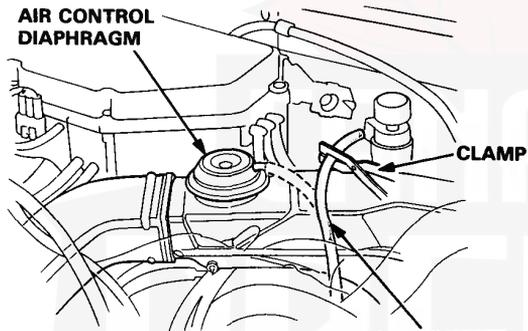

3. Check the fast idle lever.

Fast idle lever should not be seated against fast idle cam.

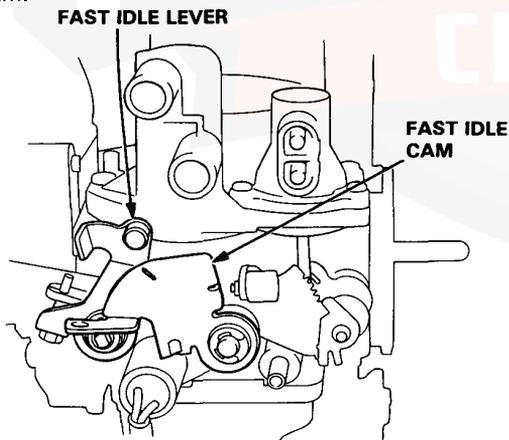

- If the fast idle lever is against the fast idle cam, replace the left carburetor.

4. Connect a tachometer.

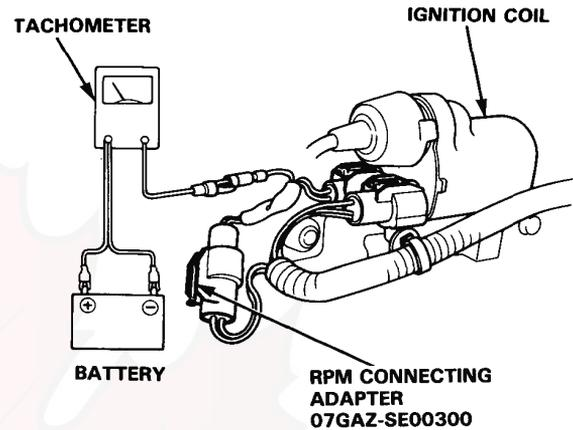

5. Check idle speed with the headlights, heater blower, rear window defogger, cooling fan and air conditioner off.

Idle speed should be:

Manual	800 ±50 min ⁻¹ (rpm)
Automatic	750 ±50 min ⁻¹ (rpm) (except "N" or "P")

Adjust the idle speed, if necessary, by turning the throttle stop screw.

NOTE: If the idle speed is excessively high, check the dashpot system.

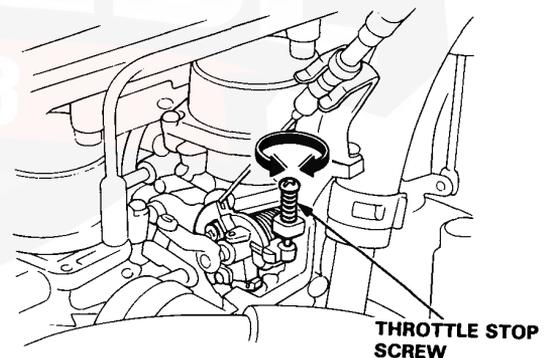

(cont'd)

Carburetor

Idle Speed/Mixture (cont'd)

6. Disconnect the 2P connector from the EACV and disconnect the hose from vacuum hose manifold, then cap the hose end.

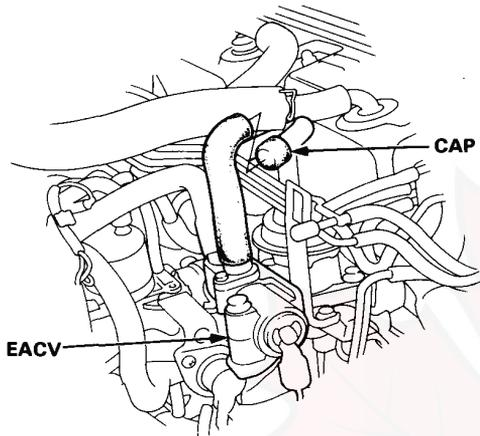

7. Disconnect the cap from vacuum hose manifold. If equipped with air conditioner, disconnect the vacuum hose from vacuum hose manifold. Disconnect air cleaner intake tube from air intake duct. Note the engine speed when starting the engine.

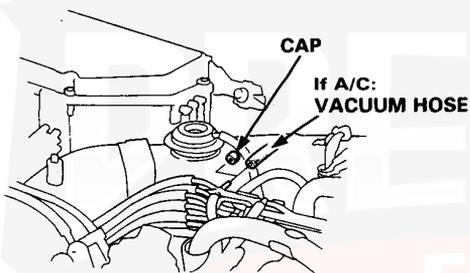

8. Insert the hose of the propane enrichment kit into the intake tube about 4-inches (10 cm).

NOTE: Check that propane bottle has adequate gas before beginning test.

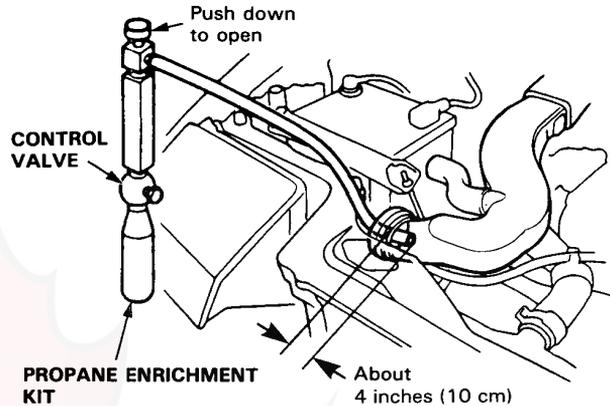

9. With engine idling, depress push button on top of propane device, then slowly open the propane control valve to obtain maximum engine speed. Engine speed should increase as percentage of propane injected goes up.

NOTE: Open the propane control valve slowly; a sudden burst of propane may stall the engine.

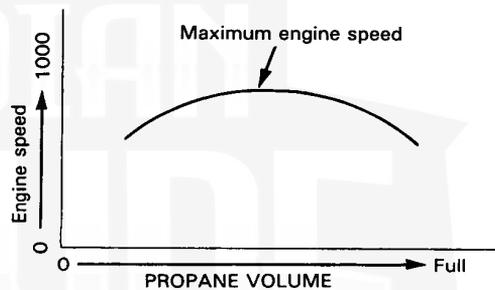

Compared to the idle speed noted in step 7.

Engine speed increase should be:
M/T: $170 \pm 20 \text{ min}^{-1} \text{ (rpm)}$
A/T: $50 \pm 10 \text{ min}^{-1} \text{ (rpm)}$ (in "D")

- If engine speed does not increase per specification, mixture is improperly adjusted. Go to step 10.
- If engine speed increases per specification, go to step 11.



10. Remove the mixture adjusting screw hole caps, and recheck maximum propane enriched engine speed.

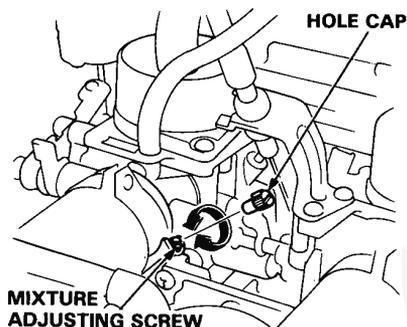

- If the propane enriched speed is too low, mixture is too rich: turn both mixture screws 1/4-turn clockwise and recheck.
 - If the propane enriched speed is too high, mixture is too lean: turn both mixture screws 1/4-turn counterclockwise and recheck.
11. Reconnect the connector and cap or hose. Close the propane control valve.
12. Remove EFI-ECU fuse for 10 seconds to reset control unit and recheck idle speed.

Idle speed should be:

Manual	800 ± 50 min ⁻¹ (rpm)
Automatic	750 ± 50 min ⁻¹ (rpm) (except "N" or "P")

- If idle speed is as specified (step 5), go to step 13.
 - If idle speed is not as specified, adjust by turning throttle stop screw, then repeat step 10.
13. Remove propane enrichment kit and reconnect air cleaner intake tube on the air intake duct.
14. Reinstall the mixture adjusting screw hole cap.
15. If equipped with 4WS, check the idle speed when the 2P connector on the P/S oil pressure switch is disconnected.

Idle speed should be:

Manual	950 ± 50 min ⁻¹ (rpm)
Automatic	830 ± 50 min ⁻¹ (rpm) (except "N" or "P")

Adjust the idle speed, if necessary, by turning the adjusting screw A.

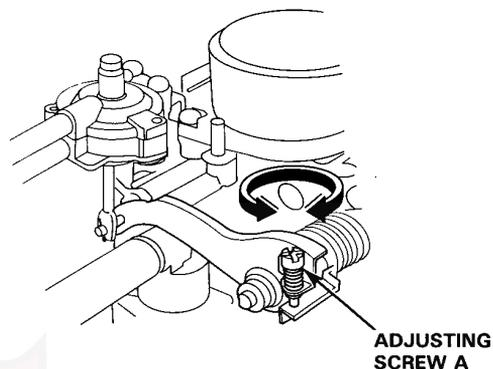

16. If equipped with 4WS, connect the 2P connector on the P/S oil pressure switch. And check the idle speed while the steering wheel is turning. **Idle speed should be:**

Manual	800 ± 50 min ⁻¹ (rpm)
Automatic	750 ± 50 min ⁻¹ (rpm) (except "N" or "P")

17. If equipped with air conditioner, check the idle speed with the A/C on. **Idle speed should be: 750 ± 50 min⁻¹ (rpm)**

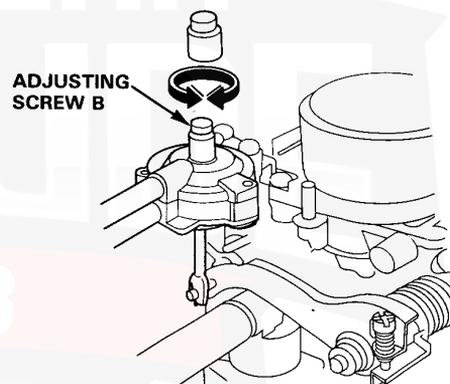

Adjust the idle speed, if necessary, by turning the adjusting screw B.

(cont'd)

Carburetor

Idle Speed/Mixture (cont'd)

[Except KS model]

CO Meter Method

▲ WARNING Do not smoke during this procedure. Keep any open flame away from your work area.

NOTE: Check that the carburetors are synchronized properly, self-diagnosis indicator (KX model) before making idle speed and mixture inspections.

1. Start the engine and warm it up to normal operating temperature (the cooling fan comes on).
2. Check the fast idle lever.

Fast idle lever should not be seated against fast idle cam.

FAST IDLE LEVER

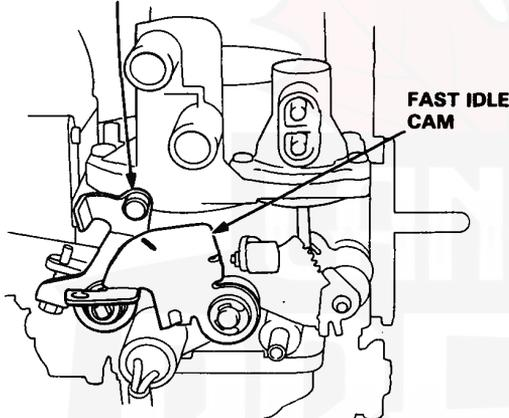

- If not, replace the left carburetor.

3. Connect a tachometer.

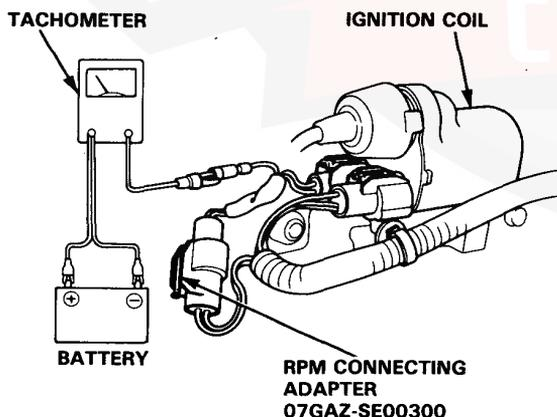

4. Check idle speed with the headlights, heater blower, rear window defogger, cooling fan and air conditioner off.

Idle Speed should be:

Manual	800 ± 50 min ⁻¹ (rpm)
Automatic	750 ± 50 min ⁻¹ (rpm) (except "N" or "P")

Adjust the idle speed, if necessary, by turning the throttle stop screw.

NOTE: If the idle speed is excessively high, check the dashpot system.

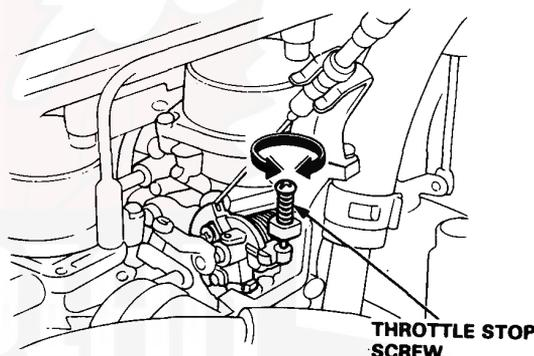

5. Calibrate the NDIR CO Meter in accordance with the manufacturer's recommended procedures. Inert exhaust gas sampling probe into the tailpipe at least 40 cm.
6. Check specification for idle CO with cooling fan, air conditioner OFF and headlights OFF.

Specified CO %:

KX, KZ model: 0.1 %

Except KX, KZ model: 1 ± 1 %

- If idle CO is as specified, go to step 14.
- If not, go to step 7 through 13.

7. KX, KZ model;
Disconnect the 2P connector from the EACV and disconnect the hose from vacuum hose manifold, then cap the hose end.

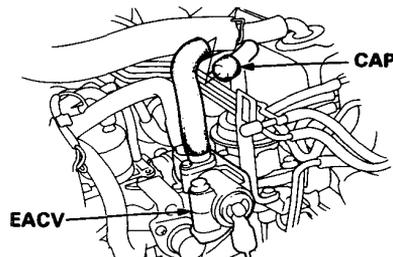



8. Remove the rubber cap from the gas pipe.

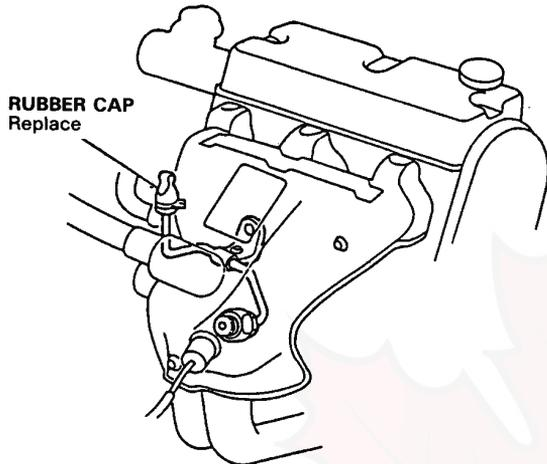

9. Check specification for idle CO.

Specified CO % : 2.0 ± 1.0 %

- If not within specification, remove mixture adjusting screw hole caps and adjust by turning both mixture adjusting screws to obtain proper CO reading.

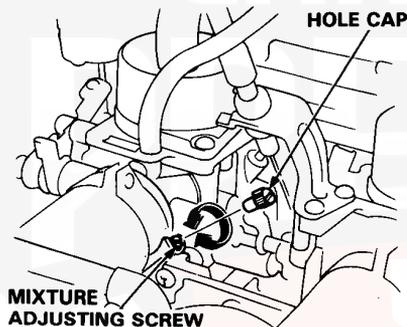

— Turning both mixture adjusting screws

clockwise: CO reading decreases
counterclockwise: CO reading increases

Readjust idle speed if necessary, and recheck idle CO.

10. KX model;
Reconnect the connector and hose.
Remove EFI. ECU fuse for 10 seconds to reset control unit.

11. KX, KZ model:
Recheck idle CO.

Specified CO % : 0.1 %

- If idle CO is as specified (step 6), go to step 11.
- If not, check the self-diagnosis indicator. If not, replace the EACV, then repeat step 6.

12. Recheck idle speed.

Idle speed should be:

Manual	$800 \pm 50 \text{ min}^{-1}$ (rpm)
Automatic	$750 \pm 50 \text{ min}^{-1}$ (rpm) (except "N" or "P")

- If idle speed is as specified (step 4), go to step 13.
- If idle speed is not as specified, adjust by turning throttle stop screw, then repeat step 6.

13. Reinstall the mixture adjusting screw hole cap.

14. KF, KG, KW, KB, KE model: If equipped with 4WS, disconnect the 2P connector on the P/S oil pressure switch, and connect a jumper wire between the 2 terminals on the wire harness. Then check the idle speed.

KX, KZ model: If equipped with 4WS, check the idle speed when the 2P connector on the P/S oil pressure switch is disconnected.

Idle speed should be:

Manual	$950 \pm 50 \text{ min}^{-1}$ (rpm)
Automatic	$830 \pm 50 \text{ min}^{-1}$ (rpm) (except "N" or "P")

Adjust the idle speed, if necessary, by turning the adjusting screw A.

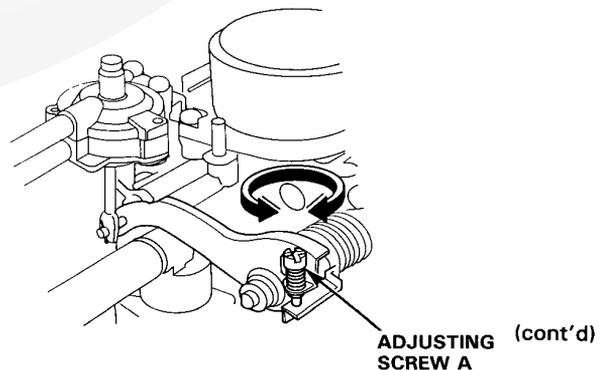

Carburetor

Idle Speed/Mixture (cont'd)

5. KX, KZ model: If equipped with 4WS, connect the 2P connector on the P/S oil pressure switch. And check the idle speed while the steering wheel is turning.

Idle speed should be:

Manual	800 ± 50 min ⁻¹ (rpm)
Automatic	750 ± 50 min ⁻¹ (rpm) (except "N" or "P")

16. If equipped with air conditioner, check the idle speed with the A/C on.

Idle speed should be: 750 ± 50 min⁻¹ (rpm)

4WS:

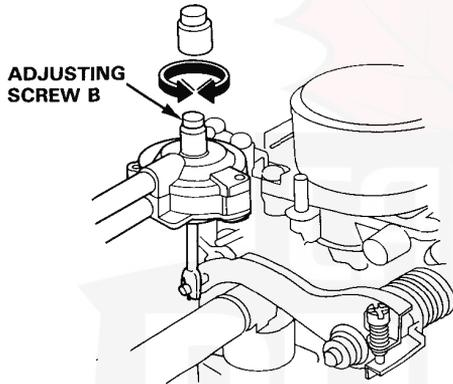

Except 4WS:

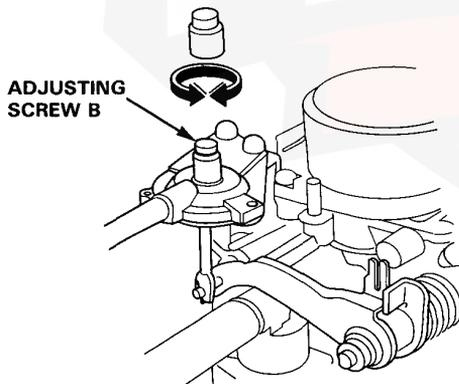

Adjust the idle speed, if necessary, by turning the adjusting screw B.



Power Valve

[KX, KS, KZ model]

Testing (COLD ENGINE)

NOTE: Intake air temperature must be below 15°C (59°F)

1. Disconnect the #14 vacuum hose from the vacuum hose manifold and connect a vacuum pump to the hose. Apply vacuum.

It should hold vacuum.

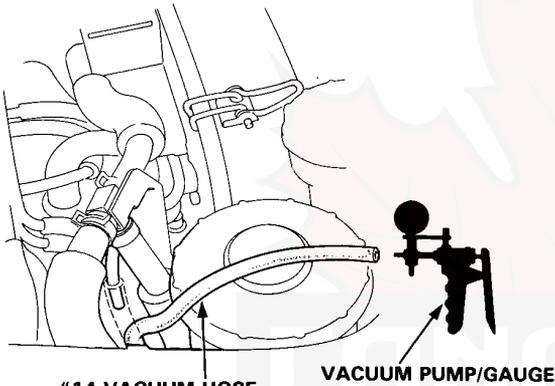

- If it does not hold vacuum, check the #14 vacuum hose for proper connection, cracks, blockage or disconnected hose, then, if necessary, replace the diaphragm and retest (page 6-80).
2. Start the engine and connect a vacuum pump/gauge to the manifold.

There should be no vacuum.

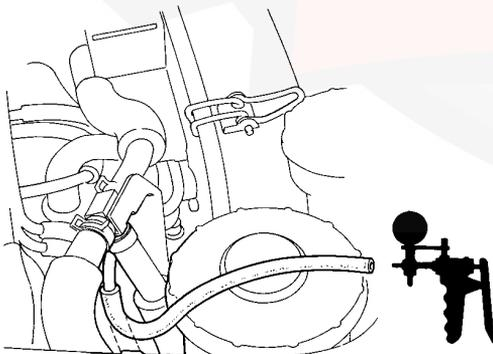

- If there is vacuum, go to troubleshooting (page 6-78).

Testing (HOT ENGINE)

1. Start the engine and warm up to normal operating temperature (cooling fan comes on).
2. Disconnect the #14 vacuum hose from the vacuum hose manifold and connect a vacuum pump/gauge.

There should be vacuum.

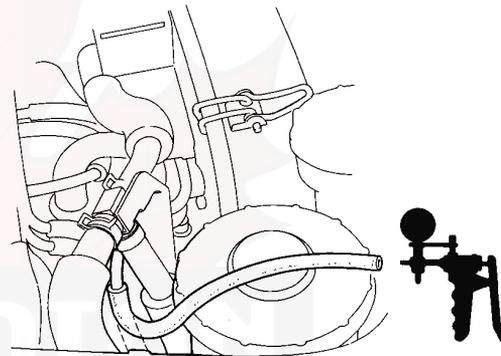

- If there is no vacuum, check the vacuum hose and vacuum hose manifold for proper connection, cracks, blockage or disconnected hose. If OK, go to troubleshooting (page 6-78).

(cont'd)

Carburetor

Power Valve (cont'd)

Troubleshooting Flowchart Power Valve Control Solenoid Valve

[KX, KS, KZ model]

Inspection of Power Valve Control Solenoid Valve.

Disconnect the #14 vacuum hose of the solenoid valve from the vacuum hose manifold and connect a vacuum gauge.

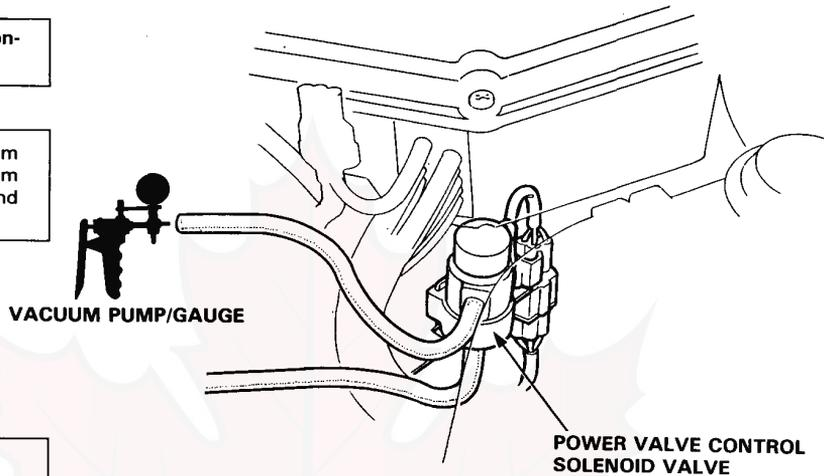

Start the engine.

NOTE: Intake air temperature must be below 15°C (59°F).

Is vacuum indicated on the gauge?

YES

Turn the ignition switch OFF.

NO

Warm up to normal operating temperature (the cooling fan comes on).

Disconnect the 4P connector near the solenoid valve.

Start the engine.

Measure voltage between GRN/YEL (+) terminal and BLK (-) terminal on the wire harness.

Is there battery voltage?

YES

Replace the solenoid valve.

NO

Measure voltage between GRN/YEL (+) terminal and body ground.

Is there battery voltage?

YES

Repair open in BLK wire between the solenoid valve and G202.

NO

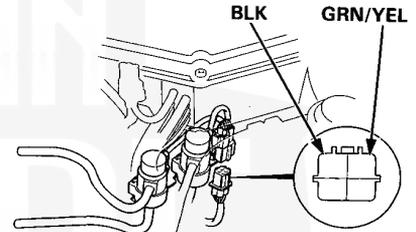

(To page 6-79)

(To page 6-79)

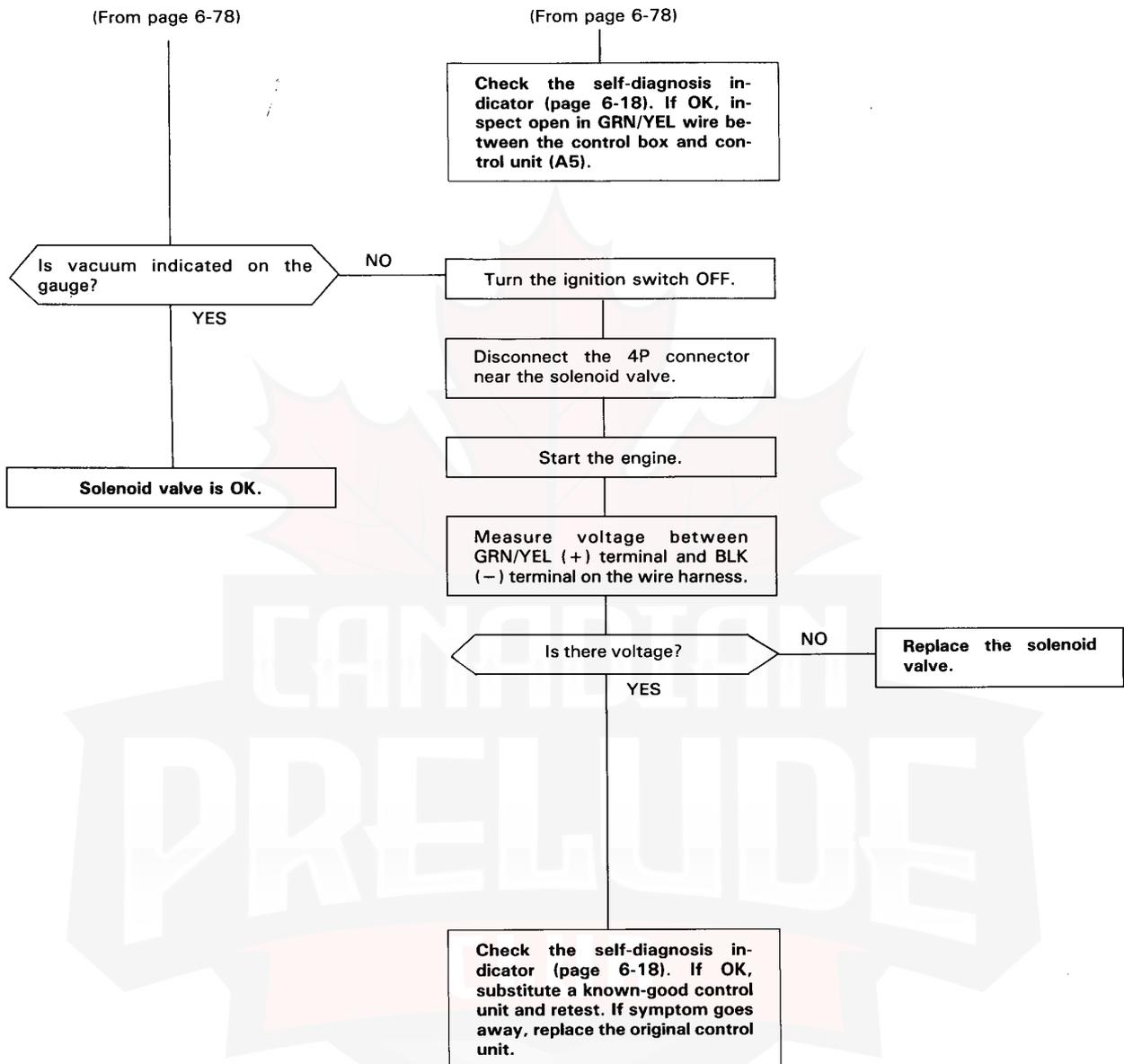

Carburetor

Replacement

⚠ WARNING Do not smoke while working on fuel system. Keep any open flame away from your work area. Drain fuel in to an approved container.

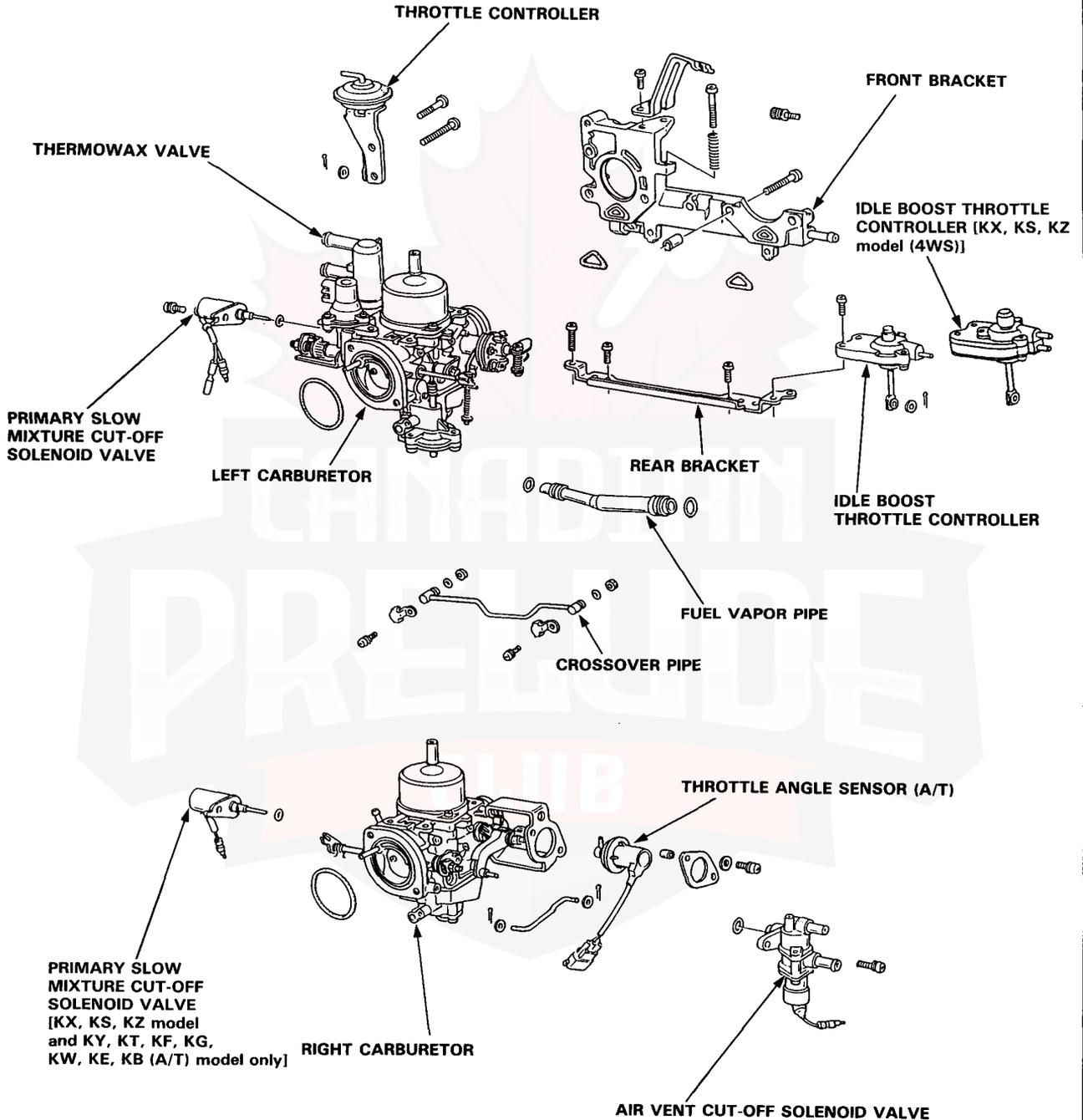



Fuel Supply System

Symptom-to-sub System Chart

NOTE:

- Across each row in the chart, the sub systems that could be sources of a symptom are ranked in the order they should be inspected, starting with ①. Find the symptom in the left column, read across to the most likely source, then refer to the page listed at the top of that column. If inspection shows the system is OK, try the next system ②, etc.
- Before starting inspection, check that other items that affect engine performance are within specification. Check the warning light and the self-diagnosis indicator, valve clearance, air cleaner, and PCV valve. In addition, check the ignition timing, function of the vacuum and centrifugal advance, and the condition of the spark plugs. If those items are all within specifications, begin with the troubleshooting listed in this page.

PAGE		SYSTEM	FUEL FILTERS	FUEL PUMP	FUEL CUT-OFF RELAY	FUEL TANK	CONTAMINATED FUEL
SYMPTOM			—	82	—	—	*
ENGINE WON'T START			③	①	②		③
POOR PERFORMANCE	MISFIRE OR ROUGH RUNNING		②				①
	LOSS OF POWER		①				②

* Fuel with dirt, water or a high percentage of alcohol is considered contaminated.

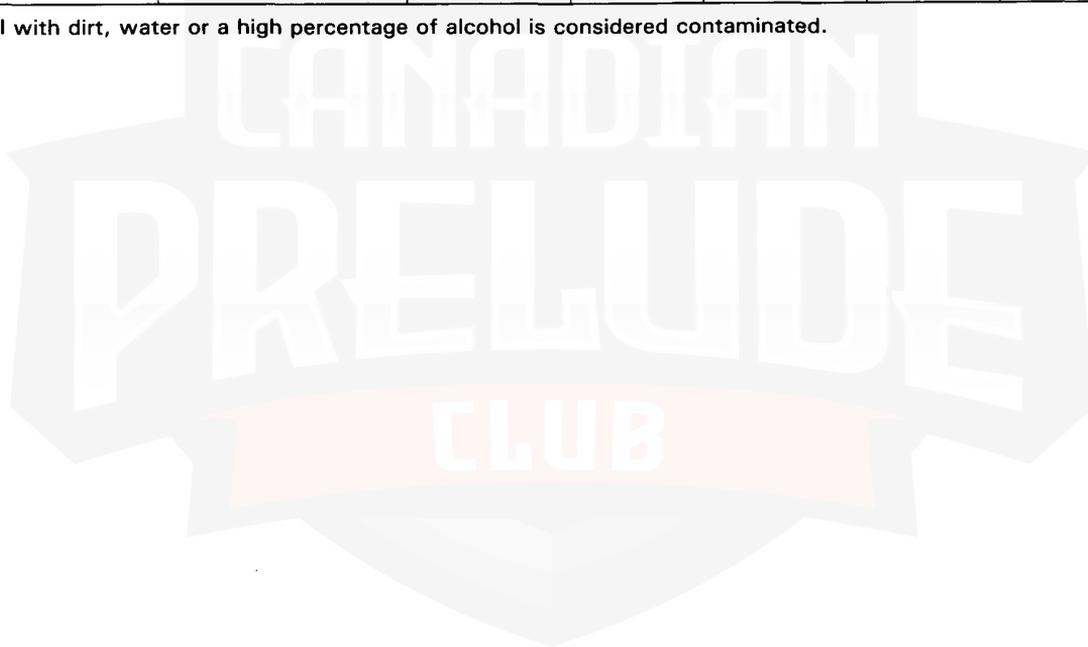

Fuel Supply System

Fuel Pump

Testing

⚠ WARNING Do not smoke during the test. Keep any open flame away from your work area.

NOTE: Check for a clogged fuel filter and or fuel line before checking fuel pump pressure.

1. Remove the dashboard under cover and the fuel cut-off relay from the fuse box.
2. Connect the No.1 terminal to the No.2 terminal located at the fuse box side of the fuel cut-off relay.

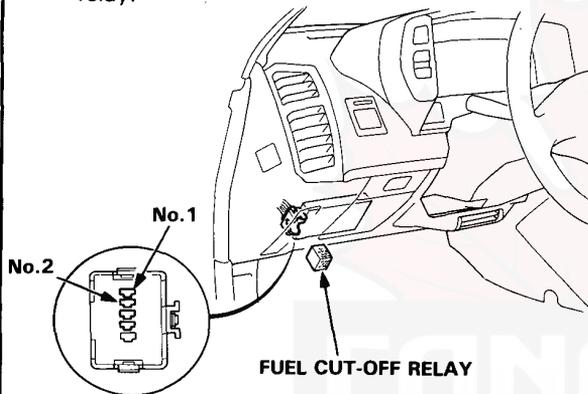

3. Hold a graduated container under the hose. container under the hose.
4. Turn the ignition ON for 60 seconds and measure amount of fuel flow.

Fuel flow should be more than 600 cm³ (20 oz.) in 60 seconds.

- If fuel flow is 600 cm³ (20 oz.), or more in 60 seconds, reconnect cut-off relay and fuel hose.
- If fuel is less than 600 cm³ (20 oz.), check the fuel cut-off relay.

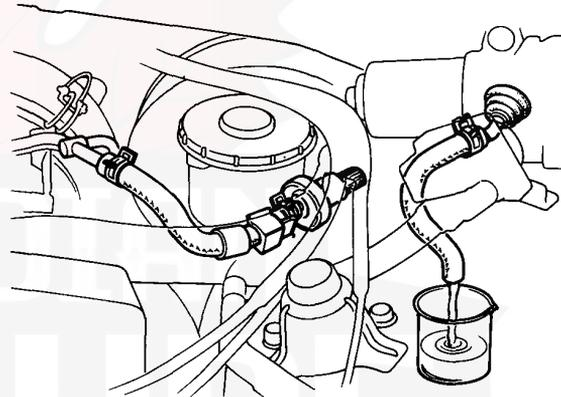

Emission Control System



Symptom-to-Sub System Chart

NOTE:

- Across each row in the chart, the sub systems that could be sources of a symptom are ranked in the order they should be inspected, starting with ①. Find the symptom in the left column, read across to the most likely source, then refer to the page listed at the top of that column. If inspection shows the system is OK, try the next system ②, etc.
- Before starting inspection, check that other items that affect engine performance are within specification. Check the warning light and the self-diagnosis indicator, valve clearance, air cleaner, and PCV valve. In addition, check the ignition timing, function of the vacuum and centrifugal advance, and the condition of the spark plugs. If those items are all within specifications, begin with the troubleshooting listed in this page.

PAGE		SYSTEM	FEEDBACK CONTROL	THROTTLE CONTROL	EGR	EVAPORATIVE CONTROL	AIR INJECTION
SYMPTOM			85	—	91	93	88
ENGINE WON'T START						①	
DIFFICULT TO START ENGINE	WHEN COLD		②		③	①	
	WHEN WARM		②			①	
IRREGULAR IDLING	WHEN COLD FAST IDLE OUT OF SPECIFICATION		①	③	②		
	WHEN WARM ENGINE SPEED TOO HIGH			①			
	WHEN WARM ENGINE SPEED TOO LOW		①		②		
	ROUGH IDLE/ FLUCTUATION		①		②		
FREQUENT STALLING	WHILE WARMING UP		①		②		
	AFTER WARMING UP		①		②		
POOR PERFORMANCE	MISFIRE OR ROUGH RUNNING		②		①		
	LOSS OFF POWER		②			①	
	AFTERBURN		③	②			①
	HESITATION/SURGE		①		②		

Emission Control System

Catalytic Converter

[KX, KS, KZ model]

Inspection

If excessive exhaust system back-pressure is suspected, remove the catalytic converter from the car and make a visual check for plugging, melting or cracking of the catalyst. Replace the catalytic converter if any of the visible area is damaged or plugged.

NOTE: Tighten each nut in the sequence shown below.

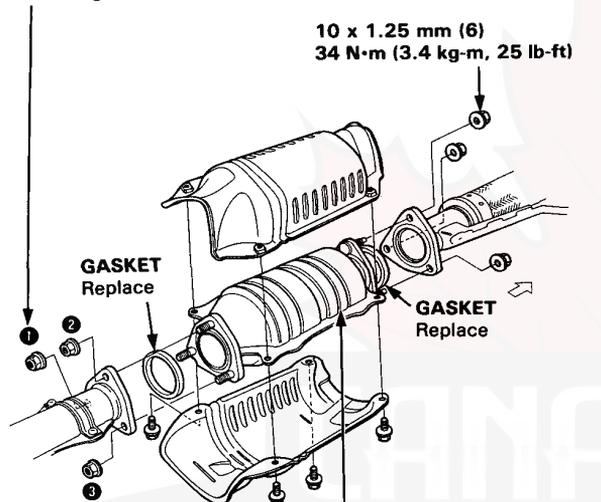

CATALYTIC CONVERTER

Removal Installation, section 5
Inspect housing for cracks or other damage.
Inspect element for clogging, by looking through the inside.



Feedback Control

[KX, KS, KZ model]

Troubleshooting Flowchart EACV

Inspection of EACV.

Start the engine and warm up to normal operating temperature (the cooling fan comes on).

Disconnect the EACV hose from the air cleaner.

Raise the engine speed to 3,500 min⁻¹ (rpm).

Is there vacuum?

NO

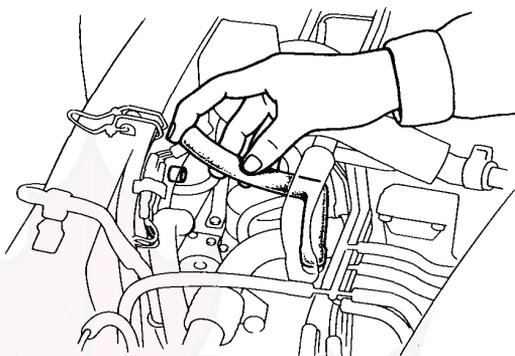

Check the self-diagnosis indicator (page 6-18). If OK, replace the EACV and retest.

YES

Raise the engine speed to 3,500 min⁻¹ (rpm), then close the throttle suddenly.

Is there vacuum?

NO

Check the self-diagnosis indicator (page 6-18).

YES

Does LED indicate code 14?

YES

Go to EACV troubleshooting flow chart (page 6-86).

NO

Check the hose for proper connection, cracks, brockage or disconnected hose. If OK, replace the EACV and retest.

EACV is OK.

(cont'd)

Emission Control System

Feedback Control (cont'd)



Self-diagnosis LED indicates code 14: A problem in the Electronic Air Control Valve (EACV) circuit.

- Engine is running.
- LED indicated CODE 14.

Turn the ignition switch OFF.

Remove EFI, ECU fuse in the under-hood relay box for 10 seconds to reset control unit.

Start engine.

Raise the engine speed to 3,500 min⁻¹ (rpm), then close the throttle suddenly.

Does LED indicate CODE 14?

NO

Intermittent failure
(test driving may be necessary.)

YES

Stop engine.

Disconnect the 2P connector on the EACV.

Measure resistance between the 2 terminals on the EACV.

(To page 6-87)

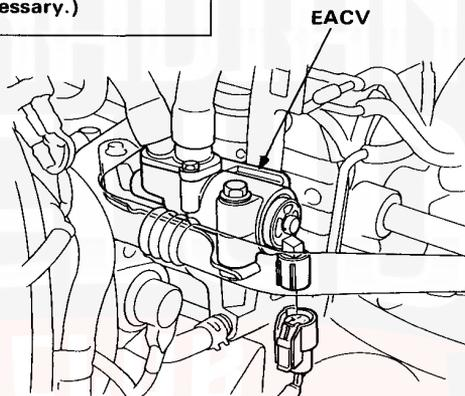



(From page 6-86)

Is there 8–15Ω? NO → Replace EACV.

YES

Check for continuity to body ground on each terminal on the EACV.

Does continuity exist? YES → Replace EACV.

NO

Reconnect the 2P connector to EACV.

Connect the ECU test harness to main wire harness, but not the control unit (page 6-16).

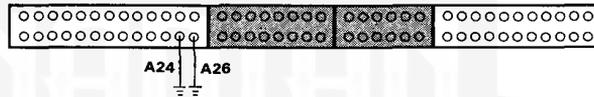

Check for continuity to the A24, A26 terminal and the body ground.

Does continuity exist? NO → Repair open BLK wire between control unit (A24, A26) and G151.

YES



Measure resistance between A3 terminal and A1 terminal.

Is there 8–15 Ω? NO → Repair open in BLU/RED wire between control unit (A1) and EACV or YEL/BLK wire between control unit (A3) and EACV.

YES

Substitute a known-good control unit and recheck. If prescribed voltage is now available, replace the original control unit.

(cont'd)

Emission Control System

Air Injection Control (cont'd)

[KX, KS, KZ model]

Testing (HOT ENGINE)

1. Start the engine and warm up to normal operating temperature (the cooling fan comes on).
2. Remove the air cleaner cover and filter.
3. Start the engine and check for a bubbling noise from the air suction port at idle.

A bubbling noise should not be heard.

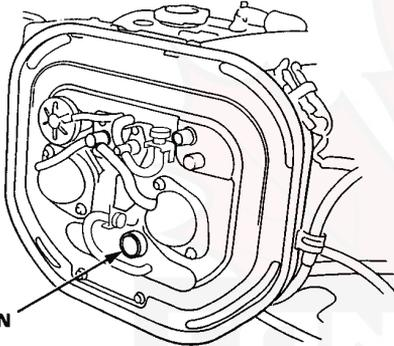

- If a bubbling noise is heard, disconnect the #5 vacuum hose from the air suction valve and connect a vacuum pump. There should be no vacuum.

VACUUM PUMP/GAUGE

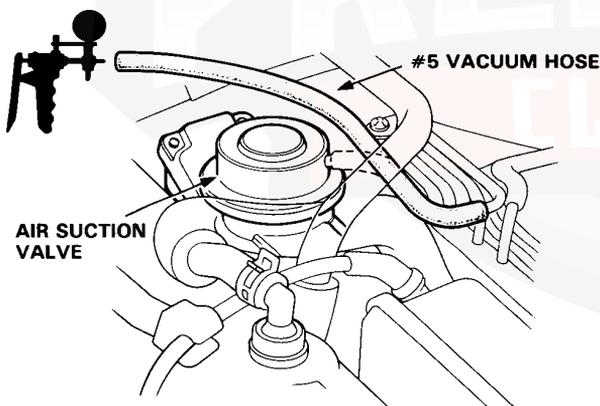

- If there is no vacuum, replace air suction valve and retest.
- If there is vacuum, go to troubleshooting (page 6-89).

4. Block rear wheels and set the parking brake. Jack up the front of the car and support with safety stands.

▲ WARNING Block rear wheels before jacking up front of car.

5. Place the shift or selector lever in second or 2 position and accelerate above 20 km/h, then release the throttle and check for a bubbling noise from the air suction port.

A bubbling noise should be heard.

- If bubbling noise is not heard, disconnect the #5 vacuum hose from the air suction valve and connect a vacuum pump.

There should be vacuum, when releasing the throttle from above 20 km/h.

- If there is vacuum, replace the air suction valve and retest.
- If there is no vacuum, go to troubleshooting (page 6-89).



Troubleshooting Flowchart Air Suction Control System

Inspection of Air Suction Control System

Remove the control box and open the control box lid.

Disconnect the lower vacuum hose of the solenoid valve from the 3-way joint and connect a vacuum pump.

Disconnect the #5 vacuum hose of the solenoid valve from the vacuum hose manifold and connect a vacuum gauge.

Start the engine and warm up to normal operating temperature (the cooling fan comes on).

Apply vacuum.

Does solenoid valve hold vacuum?

YES

Block rear wheels and set the parking brake. Jack up the front of the car and support with safety stand.

Place the shift or selector (lever in second or "2" and accelerate above 20 km/h, then release the throttle.

(To page 6-90)

NO

Turn the ignition switch OFF.

Disconnect the 8P connector on the control box.

⚠ WARNING Block rear wheels before jacking up front of car.

Start the engine.

Measure voltage between RED (+) terminal and BLK (-) terminal on the wire harness.

Is there voltage?

NO

Replace the solenoid valve.

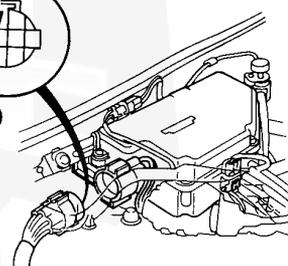
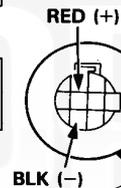

Check the self-diagnosis indicator (page 6-18). If OK, substitute a known-good control unit and retest. If symptom goes away, replace the original control unit.

(cont'd)

Emission Control System

Air Injection Control (cont'd)

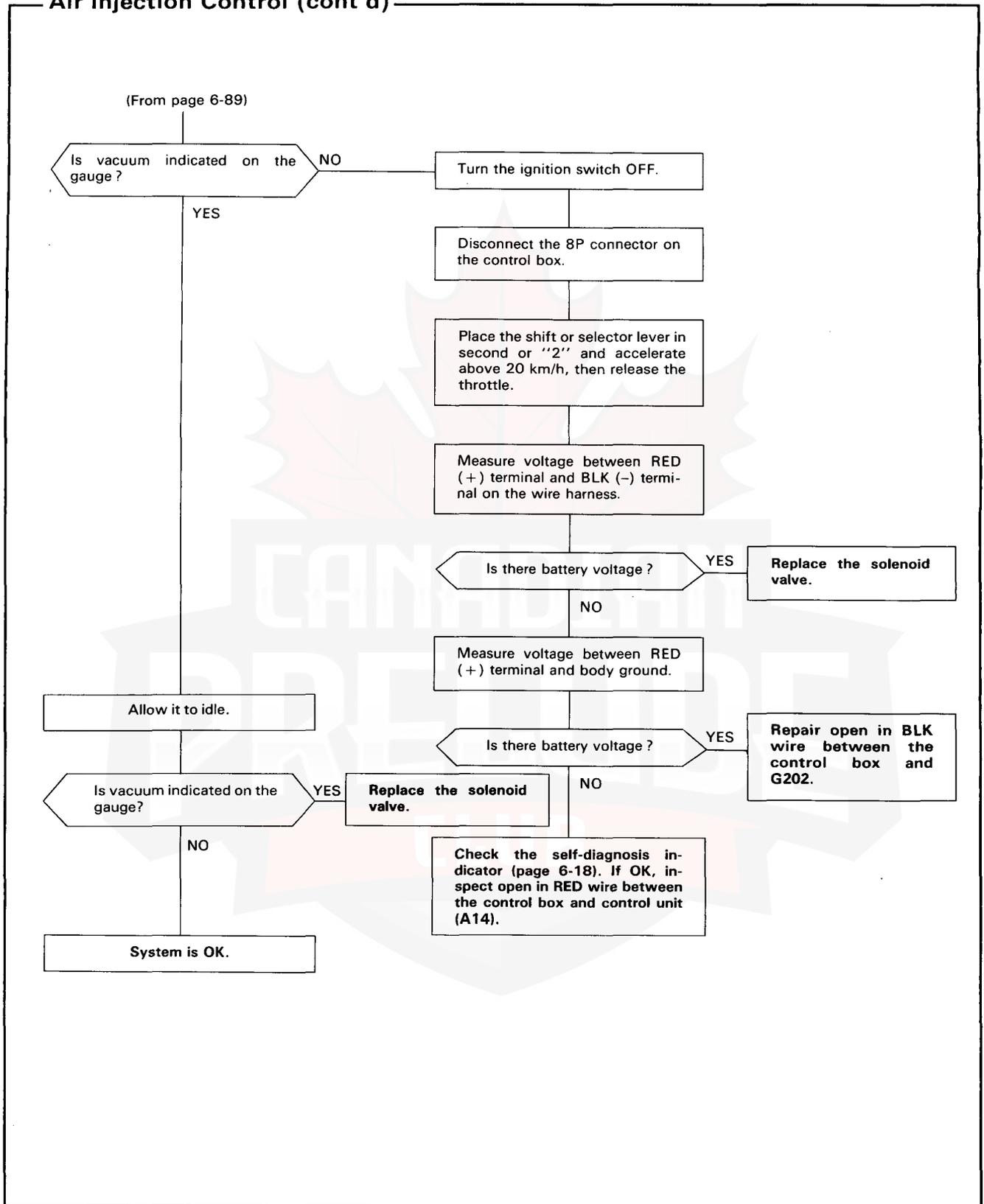



EGR

[KX, KS, KZ model]

Testing (COLD ENGINE)

NOTE: The engine coolant temperature must be below 63°C (145.4 °F)

1. Disconnect the #16 vacuum hose from the EGR valve and connect a vacuum pump to the hose.

VACUUM PUMP/GAUGE

#16 VACUUM HOSE

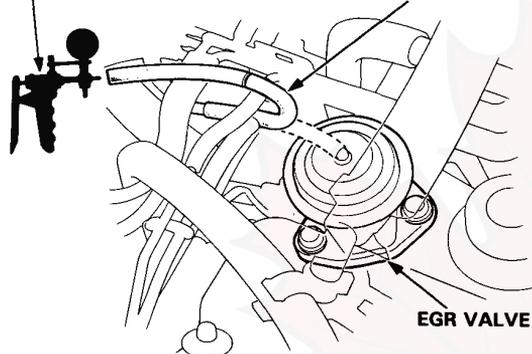

2. Start the engine and raise the engine speed to 3,000 min⁻¹(rpm).

There should be no vacuum.

- If there is no vacuum, go on to the hot engine test (next column).
- If there is vacuum, go to troubleshooting (page 6-96).

Testing (HOT ENGINE)

1. Disconnect the #16 vacuum hose from the EGR valve and connect a vacuum pump to the hose.

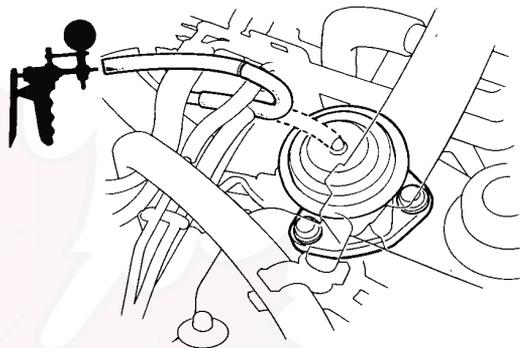

2. Start the engine and warm up to normal operating temperature (the cooling fan comes on).
3. Remove the control box and open the control box lid.
4. Remove the top hose from the purge cut-off solenoid valve and cap the solenoid valve.

Vacuum should be as shown below:

	Condition	Vacuum at EGR hose
1	Idle	No
2	3,000 min ⁻¹ (rpm)	Yes, 50–152 mm Hg
3	3,000 min ⁻¹ (rpm) with blocked vacuum bleed	Yes, less than 50 mm Hg
4	Rapid acceleration	Yes, 50–152 mm Hg
5	Deceleration	No

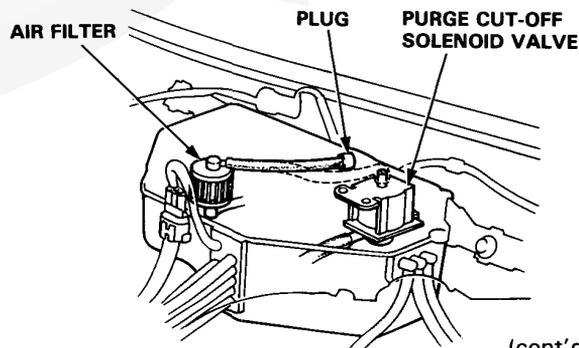

(cont'd)

Emission Control System

EGR (cont'd)

- If vacuum is available at idle (condition 1) check the vacuum hoses for proper routing and connections, then check for correct idle speed and idle mixture, and make adjustment as necessary.
- If there is no vacuum in conditions 2 and 4, go to troubleshooting (page 6-96).
- If vacuum is more than 50 mm Hg in condition 3, replace the EGR control valve and check the vacuum hoses for proper routing and connections.

EGR Valve Test

1. Start engine and allow to idle.
2. Disconnect vacuum hose from EGR valve and connect a vacuum pump to EGR valve.

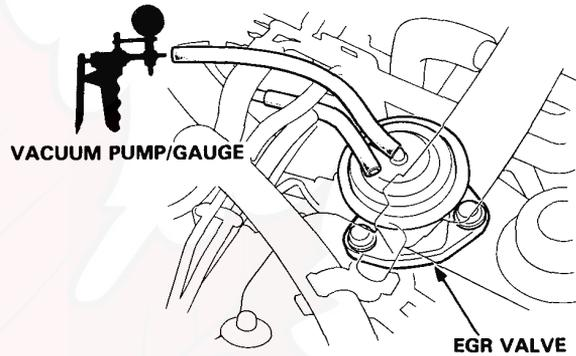

3. Apply 150 mm Hg (6 in. Hg) vacuum to EGR Valve. Vacuum should remain steady and engine should die.
 - If vacuum remains steady and engine dies, EGR valve is working properly. Remove the vacuum pump and reconnect EGR vacuum hose; test is complete.
 - If vacuum does not remain steady and engine does not die, replace EGR valve and retest.
 - If vacuum remains steady but engine does not die: Remove EGR valve; check EGR valve and manifold for blockage, clean or replace as necessary and retest.



Evaporative Emission Controls

[KX, KS, KZ model]

Testing (COLD ENGINE)

NOTE: Engine coolant temperature must be below 63°C (145°F)

1. Disconnect the #19 vacuum hose at purge control diaphragm valve and connect vacuum pump/gauge to the hose.

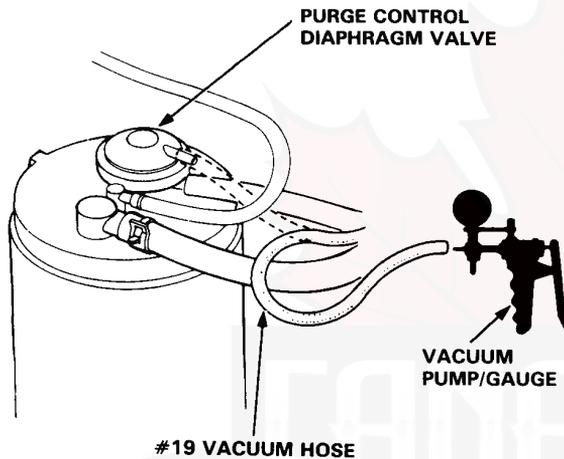

2. Start the engine and allow to idle.

There should be no vacuum.

- If there is no vacuum, go to hot engine test (next column).
- If there is vacuum, go to troubleshooting (page 6-96).

Testing (HOT ENGINE)

1. Disconnect the #19 vacuum hose at the purge control diaphragm valve and connect a vacuum pump/gauge to the hose.

PURGE CONTROL DIAPHRAGM VALVE

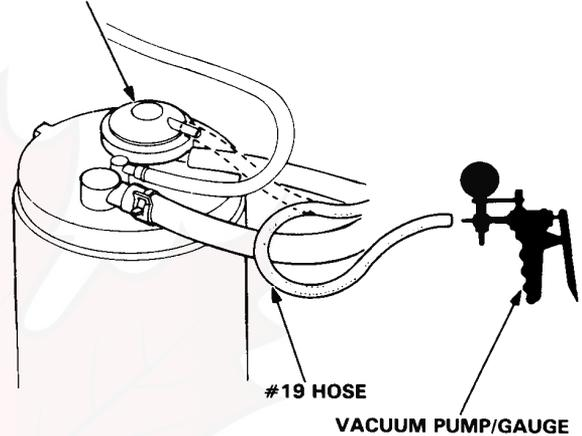

2. Start the engine and warm up to normal operating temperature (the cooling fan comes on). Block rear wheels and set the parking brake. Jack up the front of the car and support with safety stands.

⚠ WARNING Block rear wheels before jacking up front of car.

Place the shift or selector lever in 2nd gear or 2 range and raise the engine speed to 3,500 min⁻¹(rpm). There should be vacuum.

- If there is vacuum, go to step 3.
 - If there is no vacuum, go to troubleshooting (page 6-96).
3. Disconnect a vacuum pump/gauge and reconnect hose.
 4. Remove fuel filler cap.

(cont'd)

Emission Control System

Evaporative Emission Controls (cont'd)

5. Remove the canister purge air hose from frame and connect hose to a vacuum gauge as shown.

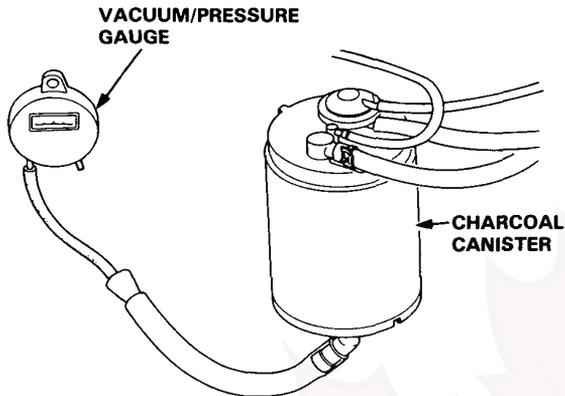

6. Place the shift or selector lever in 2nd gear or $\boxed{2}$ range and raise the engine speed to $3,500 \text{ min}^{-1}$ (rpm). Vacuum should appear on the gauge within 1 minute.

- If vacuum appears on the gauge in 1 minute, remove the gauge and go on to step 8.
- If no vacuum, disconnect the vacuum gauge and reinstall the fuel filler cap.

7. Remove the charcoal canister and check for signs of damage.

- If damaged, replace the canister.
- If OK, go on to step 8.

8. Stop the engine. Disconnect the hose from the canister PCV fitting. Connect a vacuum pump to the canister PURGE fitting as shown, and apply vacuum.

Vacuum should remain steady.

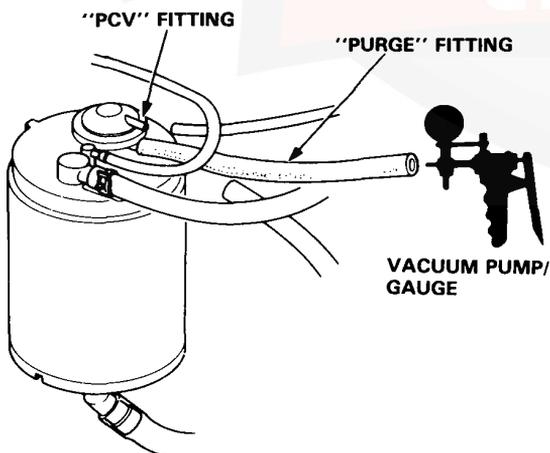

- If vacuum remains steady, go on to step 9.
- If vacuum drops, replace the canister and retest.

9. Restart the engine. Reconnect the hose to the canister PCV fitting. Raise engine to $3,500 \text{ min}^{-1}$ (rpm) (in 2nd gear or 2 range)

PURGE side vacuum should drop to zero.

- If PURGE side vacuum does not drop to zero, replace the canister and retest.

10. Connect a vacuum pump to TANK fitting as shown, and apply vacuum.

If should not hold vacuum.

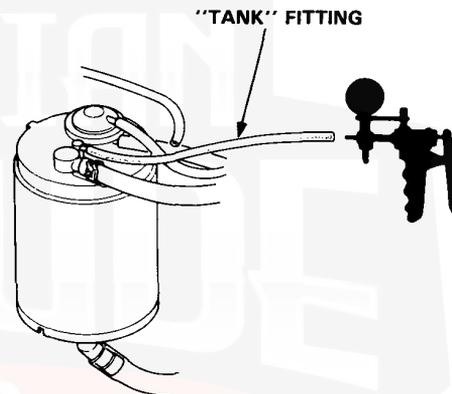

- If it does not hold vacuum, reinstall fuel filler cap and canister; test is complete.
- If it holds vacuum, replace canister and retest.



[KY model]

1. Disconnect vacuum hose at the charcoal canister, connect a vacuum pump/gauge to hose.

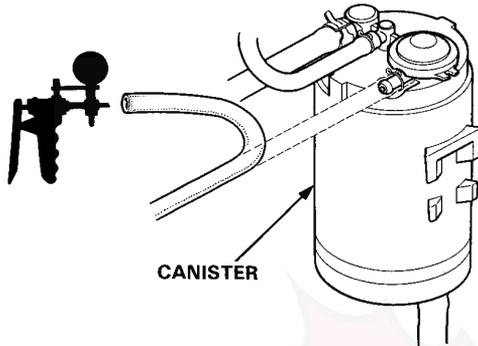

2. Start the engine and raise speed to 3,500 min⁻¹ (rpm).

There should be vacuum.

- If vacuum is available, go on to step 3.
- If vacuum is not available, check the vacuum line.

3. Disconnect a vacuum pump/gauge and reconnect hose. Remove fuel filler cap.
4. Remove canister purge air hose from frame and connect hose to a vacuum gauge as shown.

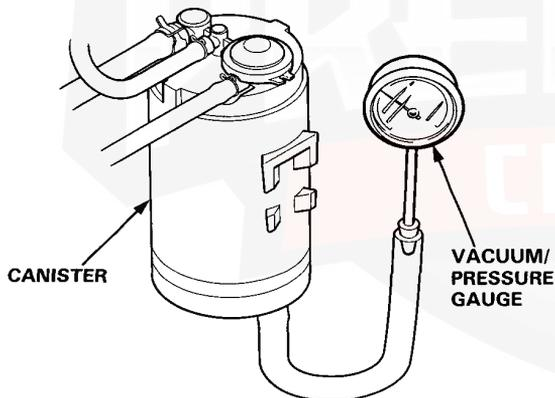

5. Raise engine speed to 3,500 min⁻¹ (rpm). Vacuum should appear on gauge within 1 minute.

- If vacuum appears on gauge in 1 minute, remove gauge and go on to step 7.
- If no vacuum, disconnect a vacuum pump/gauge and go on to step 6.

6. Remove charcoal canister and check for signs of damage or defects.

- If defective, replace the charcoal canister.
- If OK, go on to step 7.

7. Connect vacuum pump/gauge to TANK fitting as shown, and apply vacuum.

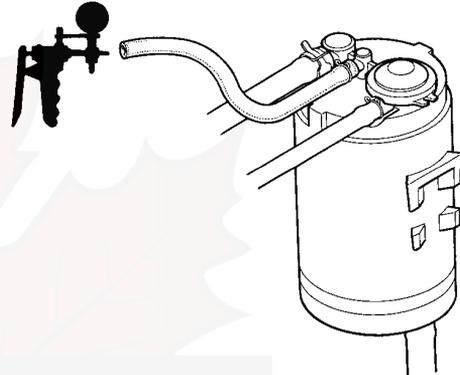

- If vacuum does not remain steady, test is complete.
- If vacuum remains steady, replace the charcoal canister.

(cont'd)

Emission Control System

Evaporative Emission Controls (cont'd)

[KX, KS, KZ model]

Troubleshooting Flowchart Purge Cut-off Solenoid Valve

Inspection of Purge Cut-off Solenoid Valve

Remove the control box and open the control box lid.

Disconnect the upper vacuum hose of the solenoid valve from the 3-way joint and connect a vacuum pump.

Start the engine.

NOTE: Engine coolant temperature must be below 63° C (145° F)

Apply vacuum.

Does solenoid valve hold vacuum?

YES

Turn the ignition switch OFF.

Disconnect the 8P connector on the control box.

Start the engine.

NO

(To page 6-97)

(To page 6-97)

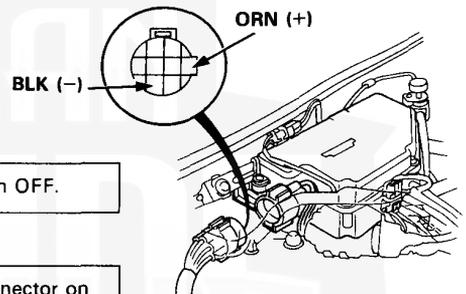
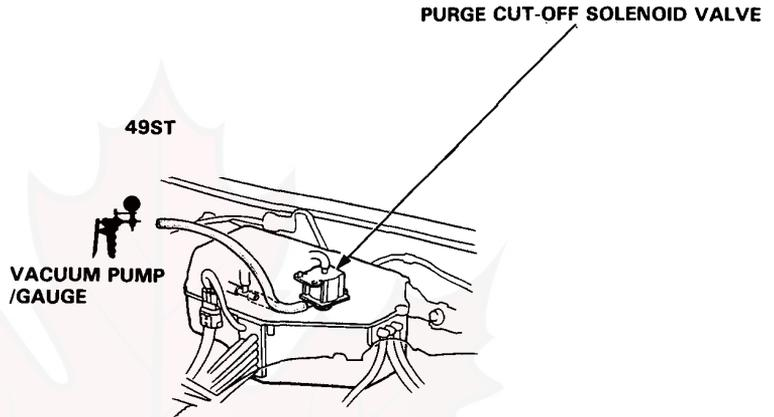

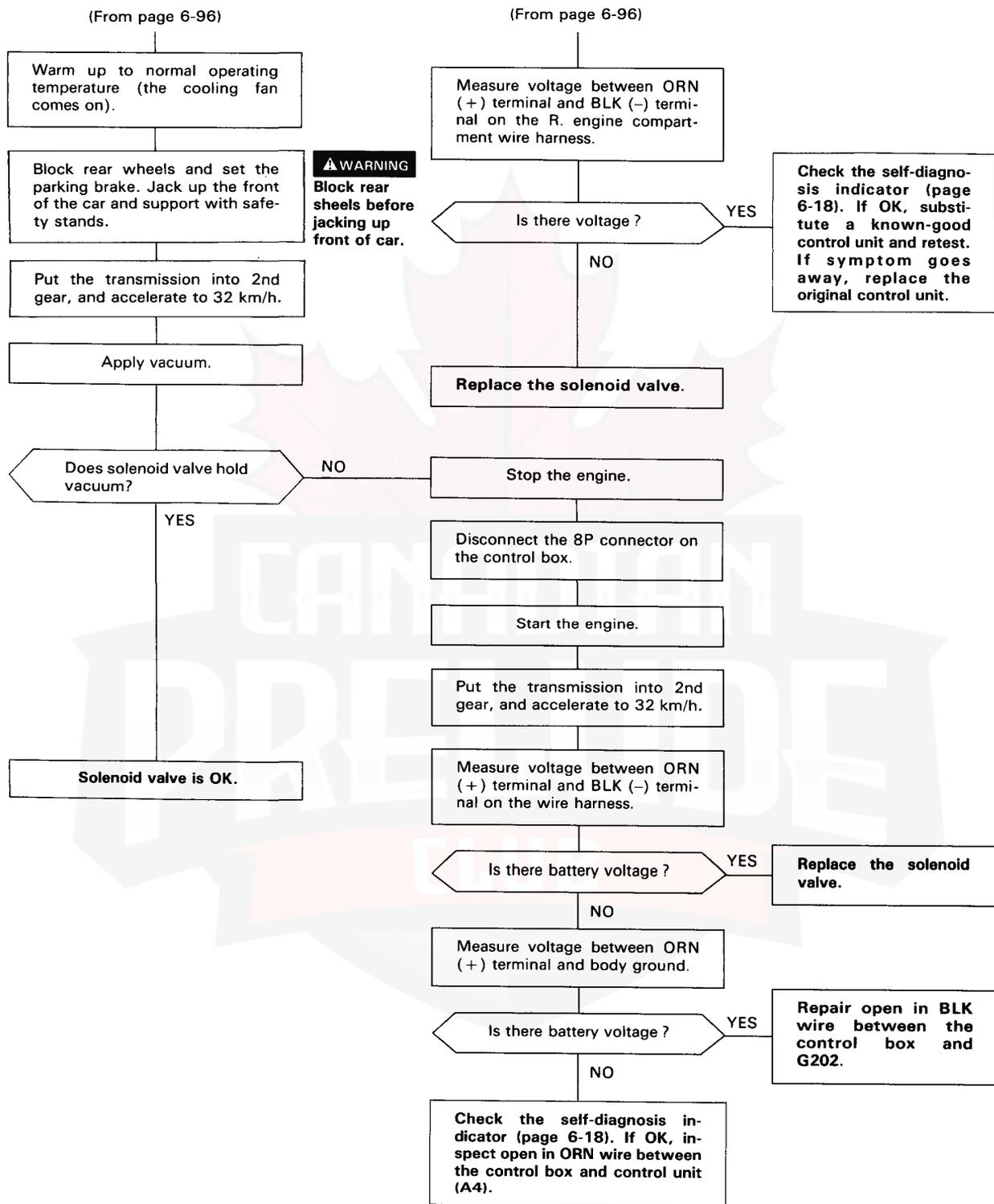

(cont'd)

Emission Control System

Evaporative Emission Controls (cont'd)

[KX, KS, KZ model]

Troubleshooting Flowchart Inner Vent Solenoid Valve

Inspection of Inner Solenoid Valve

Remove the air cleaner cover and filter element.

Disconnect two vacuum hose from the carburetor and connect a vacuum pump.

Start the engine and warm up to normal operating temperature (the cooling fan comes on).

Apply vacuum.

Does solenoid valve hold vacuum?

YES

Turn the ignition switch OFF.

Disconnect the GRN/RED connector and BLK connector near the air cleaner.

Start the engine.

Measure voltage between GRN/RED (+) terminal and BLK (-) terminal.

Is there battery voltage?

YES

Replace the solenoid valve.

NO

Stop the engine.

Apply vacuum.

(To page 6-99)

(To page 6-99)

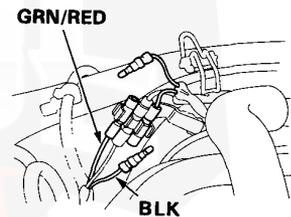
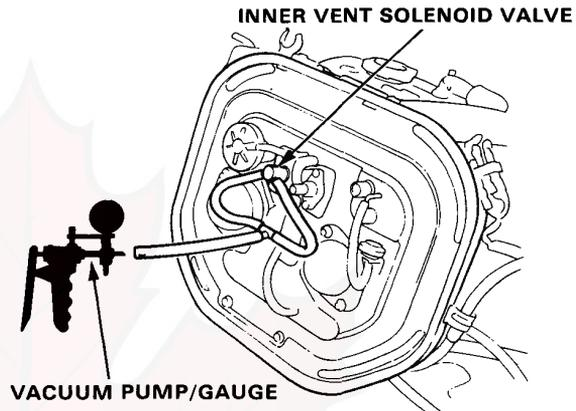

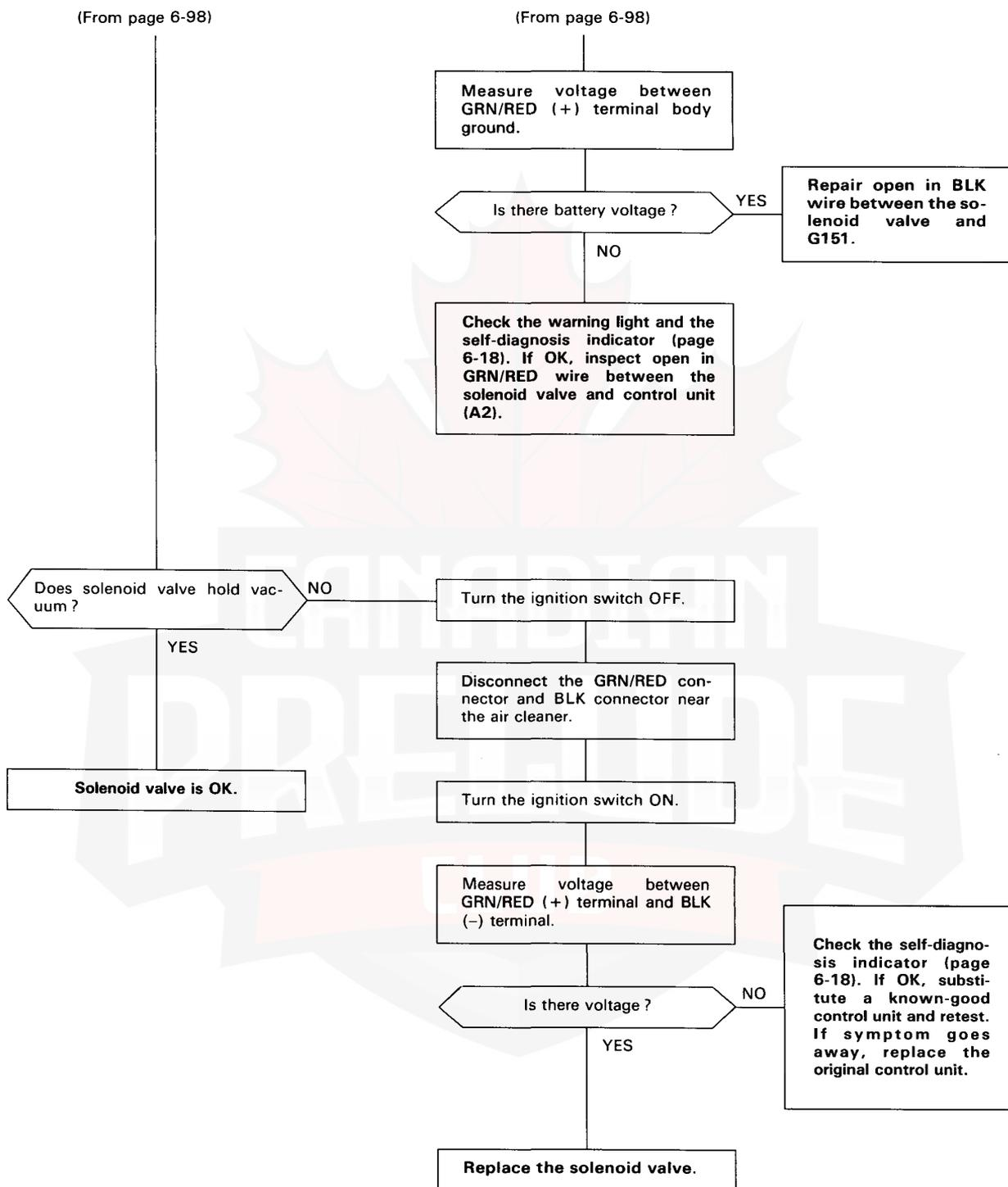

(cont'd)

Emission Control System

Evaporative Emission Controls (cont'd)

[KX, KS, KZ model]

Troubleshooting Flowchart Air vent Cut-off Solenoid Valve

Inspection of Air Vent Cut-off Solenoid Valve.

Disconnect the upper hose of the solenoid valve from the air cleaner and connect a vacuum pump.

Disconnect the lower hose of the solenoid valve.

Start the engine and warm up to normal operating temperature (the cooling fan comes on).

Apply vacuum.

Does solenoid valve hold vacuum?

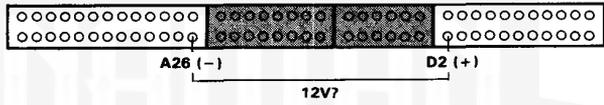
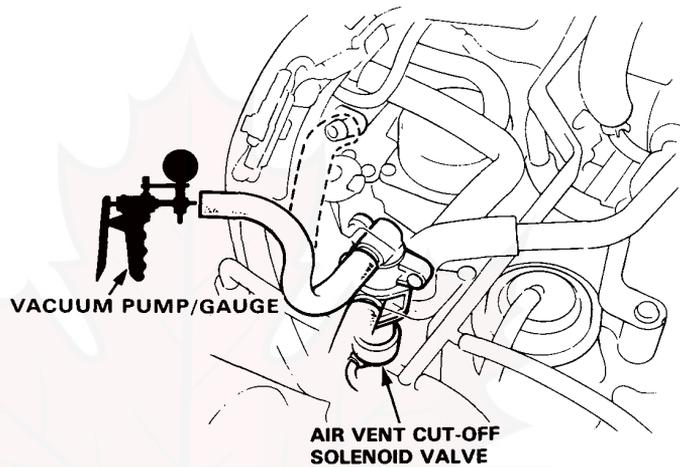

YES → Turn the ignition switch OFF.

Connect the ECU test harness between the control unit and connector (page 6-16)

Start the engine.

Measure voltage between D2 (+) terminal and A26 (-) terminal.

NO

Stop the engine.

Apply vacuum.

(To page 6-101)

(To page 6-101)



(From page 6-100)

(From page 6-100)

Is there battery voltage ?

YES

Repair open in GRN/
YEL wire between the
solenoid valve and
control unit (D2). If
OK, replace the
solenoid valve.

NO

Check the self-diagnosis in-
dicator (page 6-18). If OK,
substitute a known-good control
unit and retest. If symptom goes
away, replace the original control
unit.

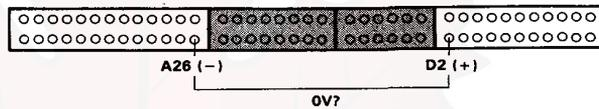

Does solenoid valve hold vac-
uum ?

NO

Turn the ignition switch OFF.

Connect the ECU test harness
between the control unit and
connector (page 6-16).

Turn the ignition switch ON.

Measure voltage between D2 (+)
terminal and A26 (-) terminal.

Is there voltage ?

NO

Check the self-diagno-
sis indicator (page
6-18). If OK, substi-
tute a known-good
control unit and retest.
If symptom goes
away, replace the
original control unit.

YES

Replace the solenoid valve.

YES

Solenoid valve is OK.

Fuel and Emissions (Fuel-Injected Engine)

Special Tools	6-104	Idle Control System	
Component Locations	6-105	Symptom-to-Sub System Chart	6-150
Vacuum Connections	6-107	Troubleshooting Flow Charts	
Electrical Connections	6-110	Electronic Air Control Valve	
Symptom-to-System Chart	6-112	[KF, KE, KB, KW, KT, KQ, KY] ...	6-152
Troubleshooting		[KZ, KS, KX]	6-155
Self-diagnostic Procedure	6-114	Air Conditioning Signal	6-158
PGM-FI Control System		Alternator FR Signal	6-160
Troubleshooting Flow Charts		A/T Shift Position Signal	6-162
Electronic Control Unit	6-117	Starter Switch Signal	6-164
Oxygen Sensor	6-120	P/S Oil Pressure Signal	6-165
Oxygen Sensor Heater	6-122	Idle Speed Inspection/Adjustment	
Fuel Supply System	6-124	[all models]	6-166
Manifold Absolute Pressure		Fuel Supply System	
Sensor	6-126	Symptom-to-Sub System Chart	6-167
TDC/CRANK Sensor	6-132	Fuel Injectors	6-168
Coolant Temperature Sensor	6-136	Air Intake System	
Throttle Angle Sensor	6-138	Symptom-to-Sub System Chart	6-172
CYL Sensor	6-140	Air Cleaner	6-173
Intake Air Temperature Sensor	6-142	Bypass Control System	6-174
Atmospheric Pressure Sensor	6-144	Emission Control System	
Ignition Output Signal	6-146	Symptom-to-Sub System Chart	6-178
Vehicle Speed Sensor	6-148	Exhaust Gas Recirculation System ...	6-179
CYL Sensor Assembly		Evaporative Emission Controls	6-184
Replacement	6-149		



Outline of Model Changes

- The Electronic Control Unit (ECU) has been changed. (KZ, KS, KX models)
- The inspection of EACV has been modified. (KF, KE, KB, KW, KT, KQ, KY models)
- The air intake tube has been changed.

Special Tools

Special Tools

Ref. No	Tool Number	Description	Q'ty	Remarks
①	07LAJ-PT30100	ECU Test Harness	1	

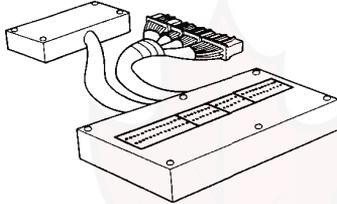
A technical drawing of an ECU Test Harness. It consists of a rectangular metal housing with a multi-pin connector on the top surface. Two wires are connected to the harness, one leading to a smaller rectangular component and the other to a multi-pin connector. A circled number 1 is positioned below the harness.

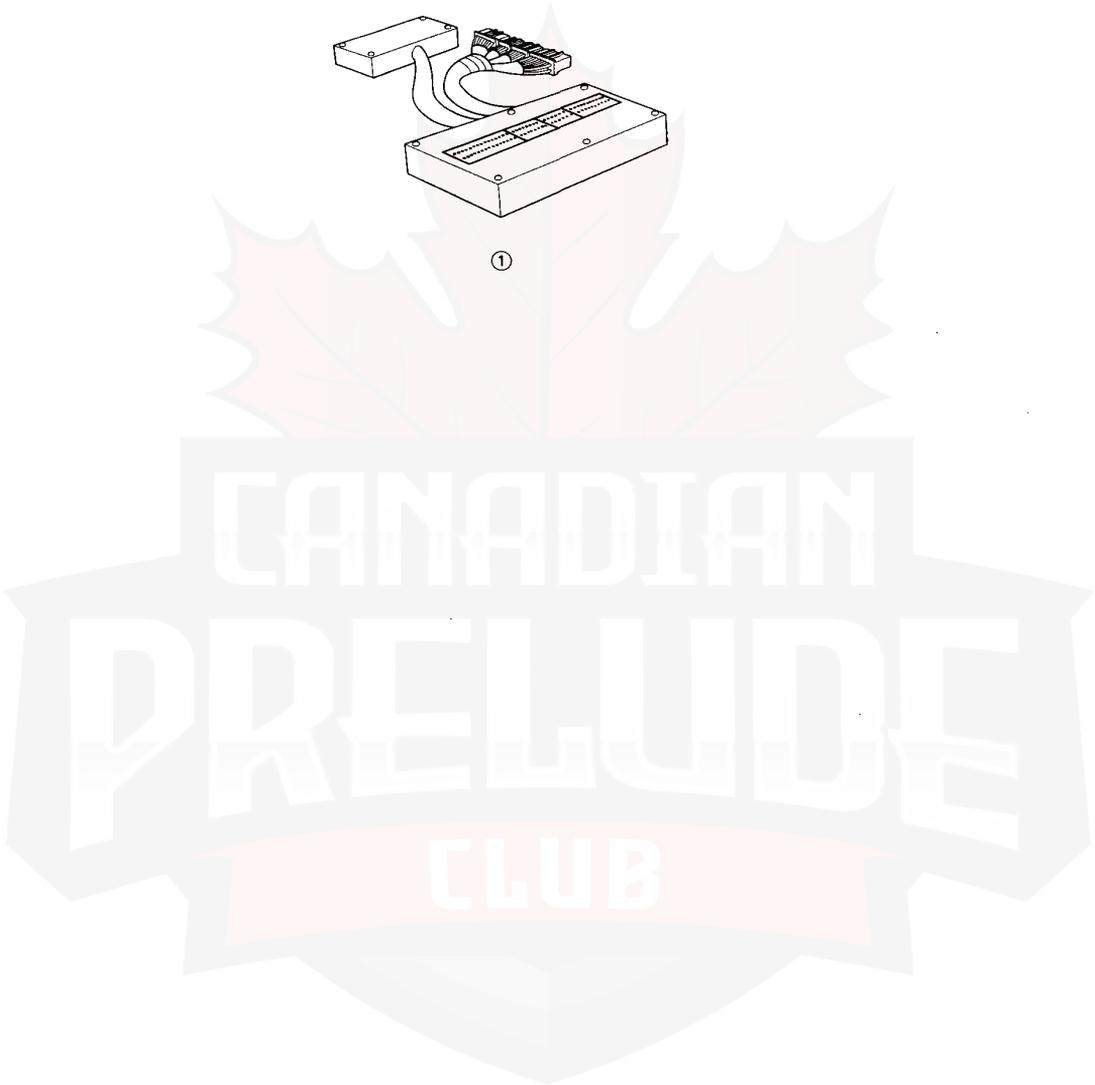
A large, semi-transparent watermark logo for the Canadian Prelude Club. It features a stylized red maple leaf at the top, with the words "CANADIAN PRELUDE CLUB" in a bold, blocky font below it. The word "PRELUDE" is the largest and most prominent.

Component Locations



Index

[all models]

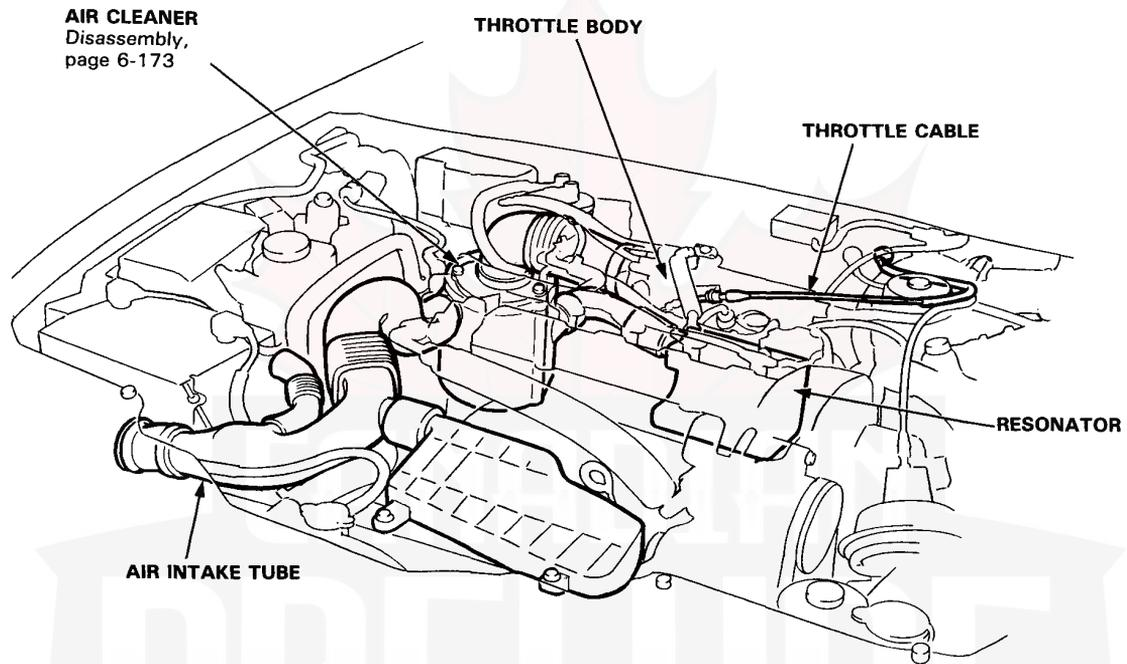

Component Locations

Index

[KZ, KS, KX]

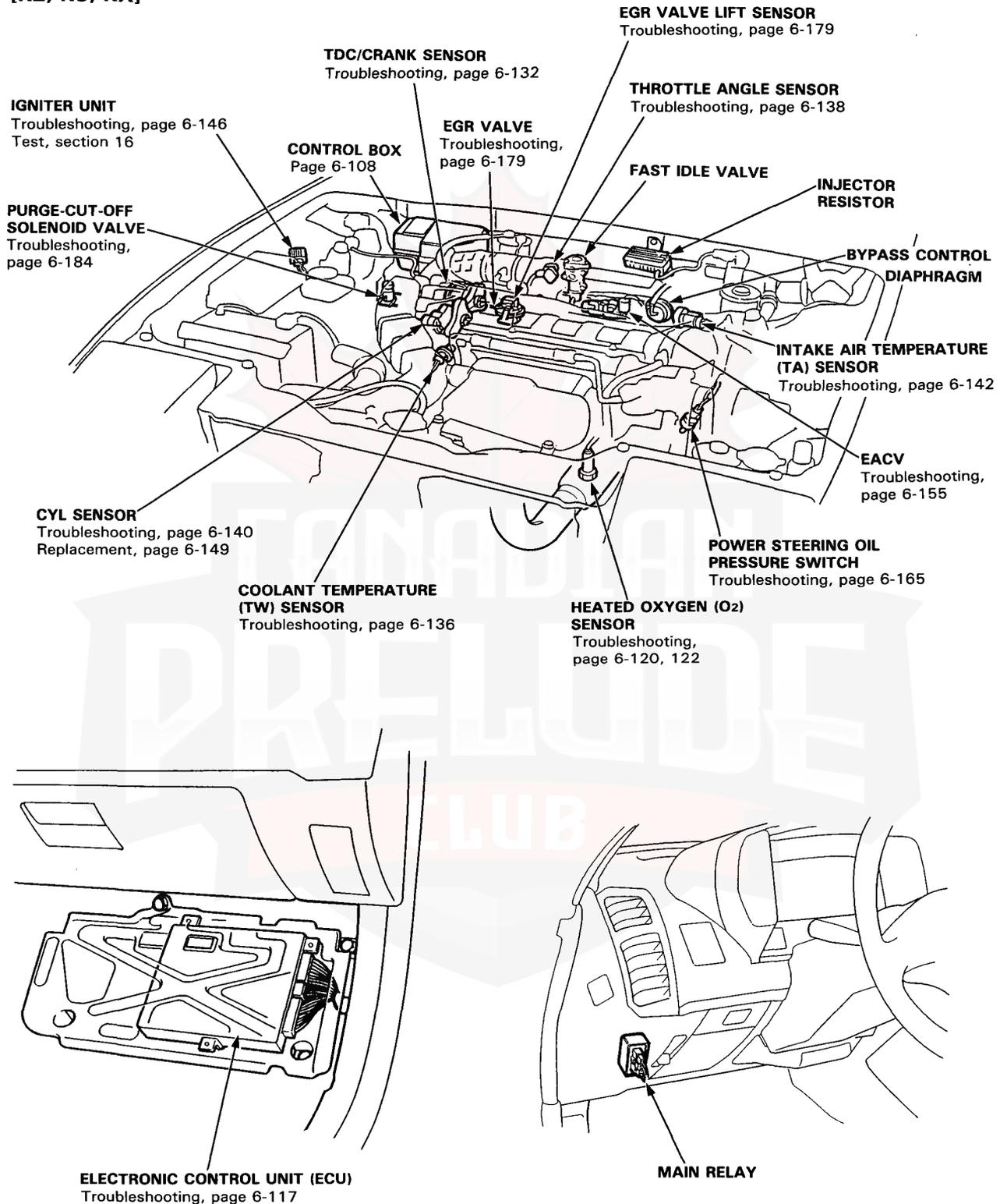

System Description



Vacuum Connections

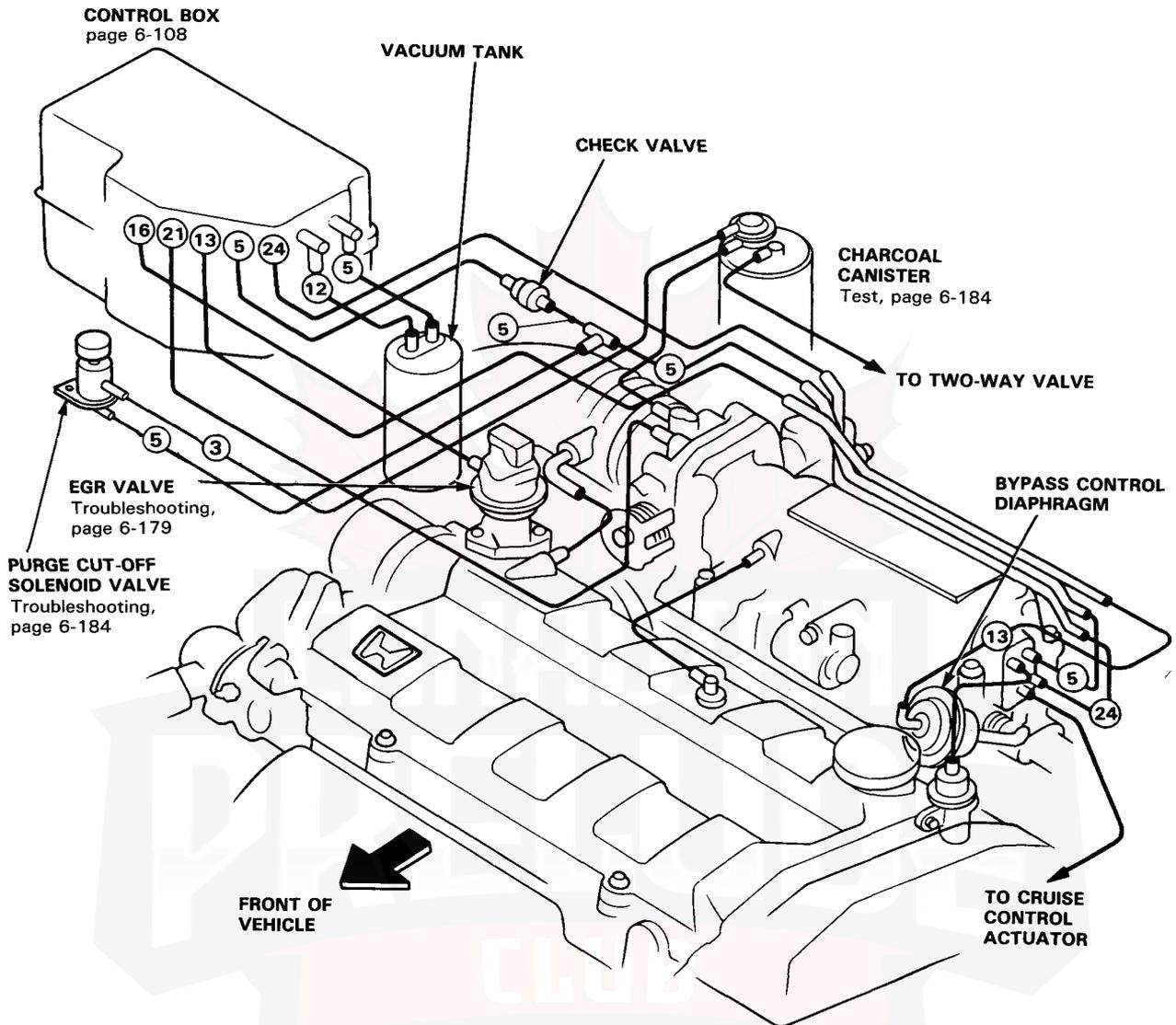

(cont'd)

System Description

Vacuum Connections (cont'd)

Control Box

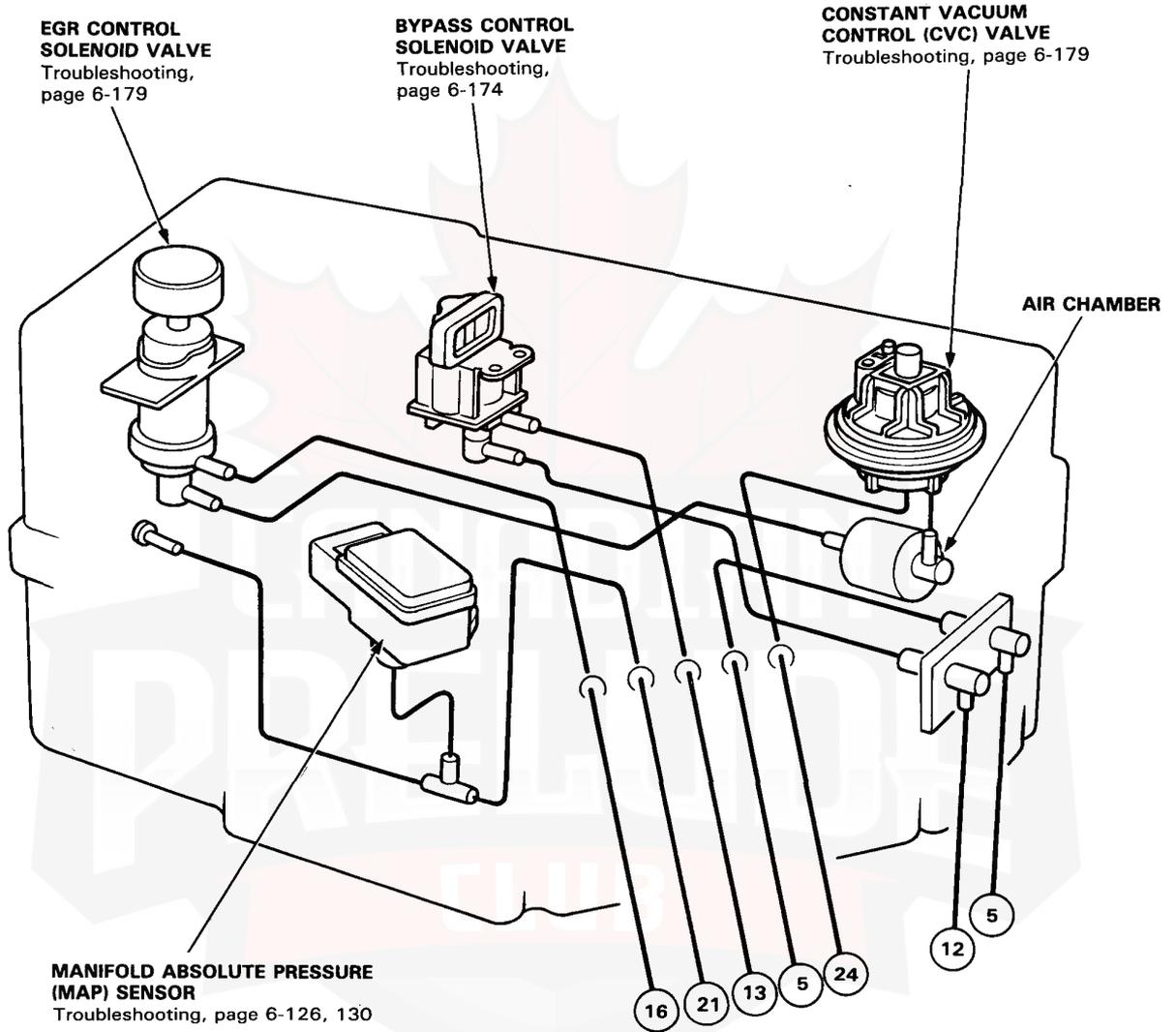

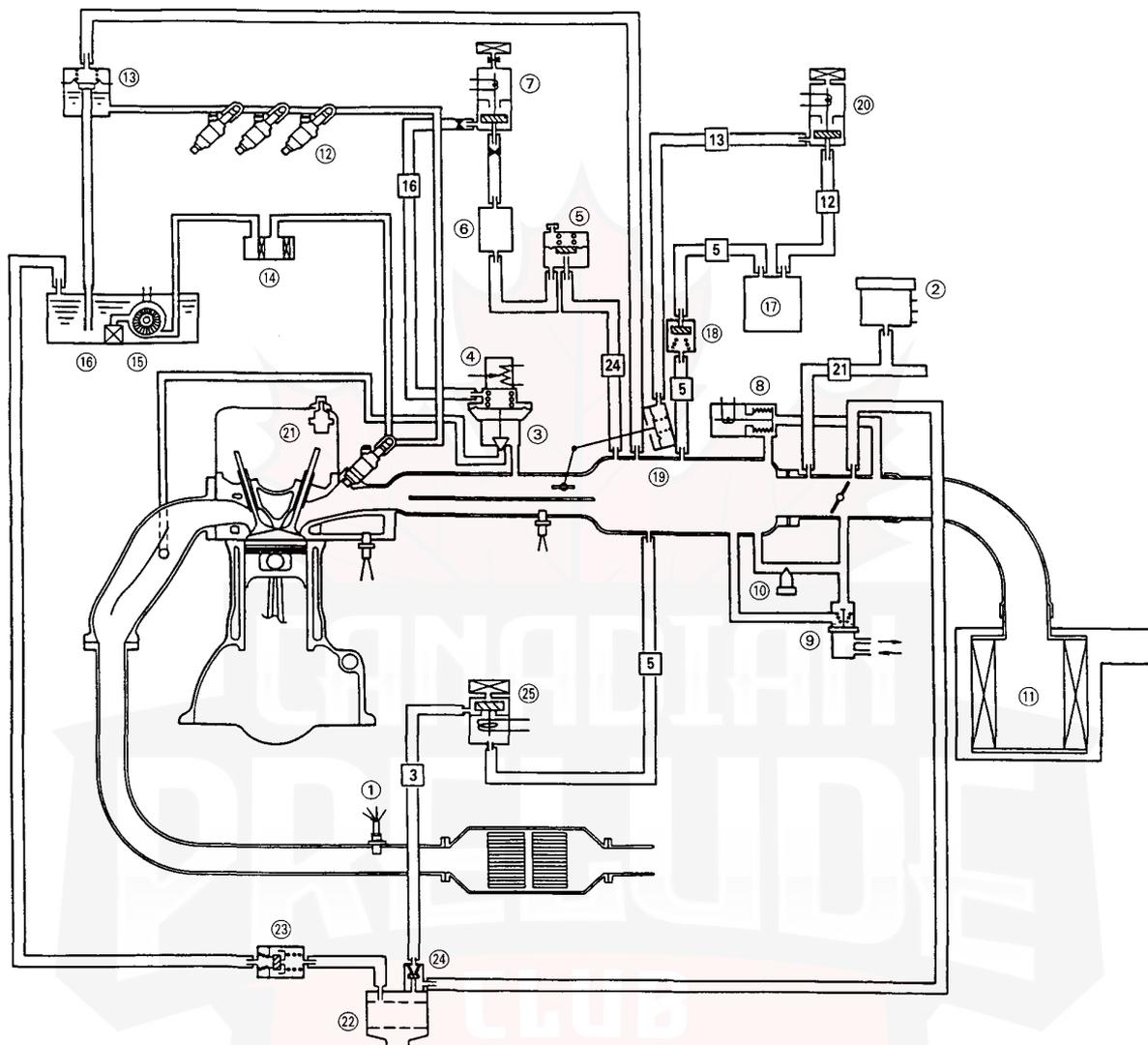

- | | |
|---|---------------------------------|
| ① HEATED OXYGEN (O ₂) SENSOR | ⑭ FUEL FILTER |
| ② MANIFOLD ABSOLUTE PRESSURE (MAP) SENSOR | ⑮ FUEL PUMP |
| ③ EGR VALVE | ⑯ FUEL TANK |
| ④ EGR VALVE LIFT SENSOR | ⑰ VACUUM TANK |
| ⑤ CONSTANT VACUUM CONTROL (CVC) VALVE | ⑱ CHECK VALVE |
| ⑥ AIR CHAMBER | ⑲ BYPASS CONTROL DIAPHRAGM |
| ⑦ EGR CONTROL SOLENOID VALVE | ⑳ BYPASS CONTROL SOLENOID VALVE |
| ⑧ ELECTRONIC AIR CONTROL VALVE (EACV) | ㉑ PCV VALVE |
| ⑨ FAST IDLE VALVE | ㉒ CHARCOAL CANISTER |
| ⑩ IDLE ADJUSTING SCREW | ㉓ TWO-WAY VALVE |
| ⑪ AIR CLEANER | ㉔ PURGE CONTROL DIAPHRAGM VALVE |
| ⑫ FUEL INJECTOR | ㉕ PURGE CUT-OFF SOLENOID VALVE |
| ⑬ PRESSURE REGULATOR | |

System Description

Electrical Connections

FUSES

- ① EFI ECU (10A)*
 - ② No. 12 (10A)
 - ③ No. 1 (7.5A) (A/T)
 - ④ No. 13 (10A)
 - ⑤ CLOCK (10A)*
- *: In the under-hood relay fuse box

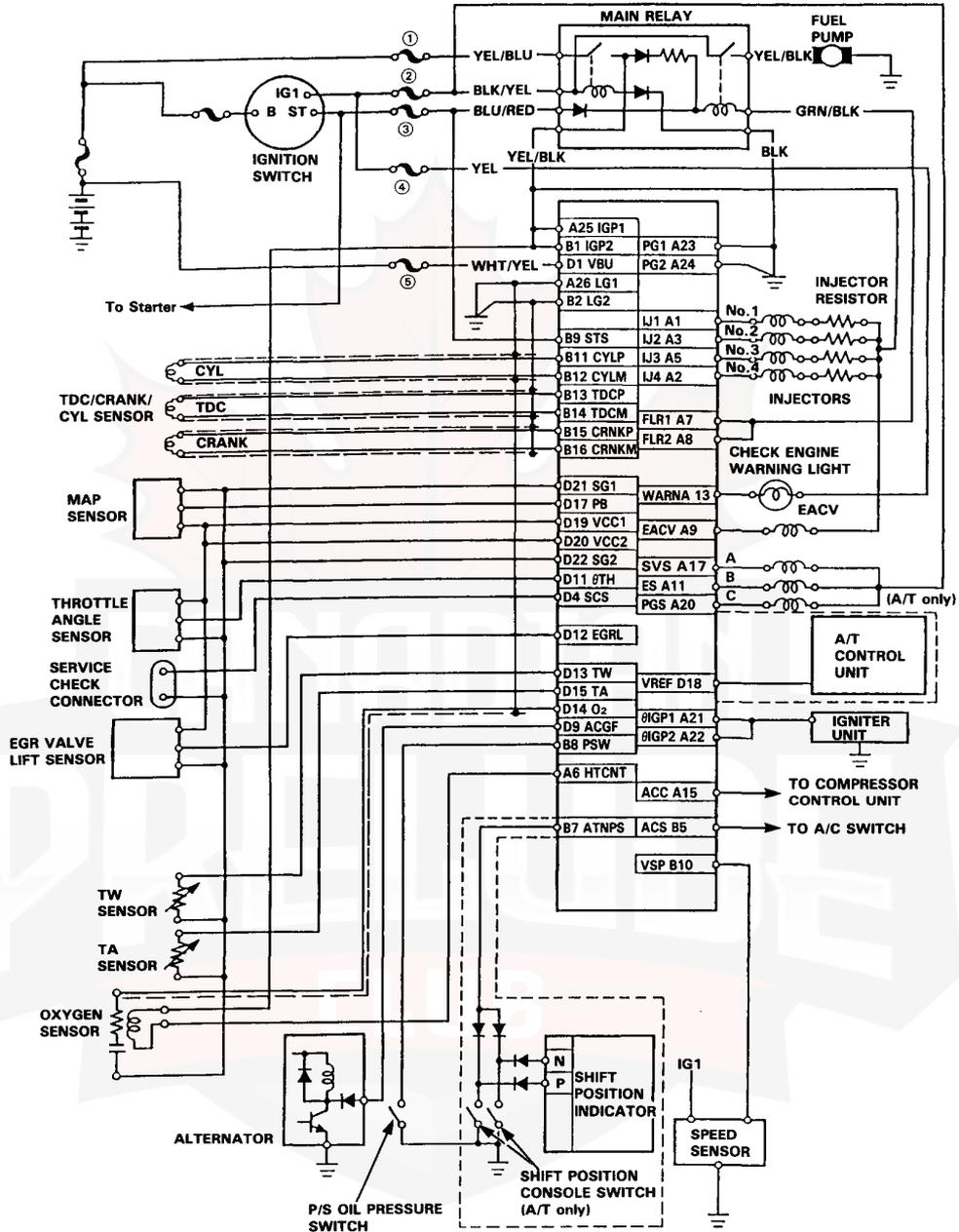

A: BYPASS CONTROL SOLENOID VALVE
 B: EGR CONTROL SOLENOID VALVE
 C: PURGE CUT-OFF SOLENOID VALVE

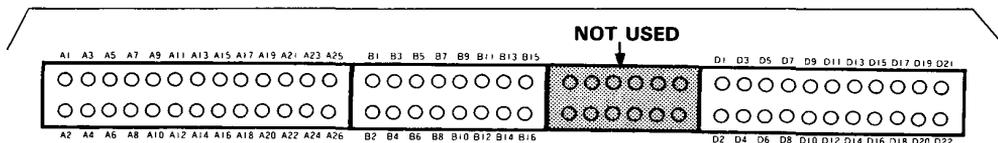

TERMINAL LOCATION



Troubleshooting

Troubleshooting Guide

NOTE: Across each row in the chart, the systems that could be sources of a symptom are ranked in the order they should be inspected starting with ①. Find the symptom in the left column, read across to the most likely source, then refer to the page listed at the top of that column. If inspection shows the system is OK, try the next most likely system ②, etc.

SYSTEM		PGM-FI							
		ECU	OXYGEN SENSOR	MANIFOLD ABSOLUTE PRESSURE SENSOR	TDC/ CRANK SENSOR	COOLANT TEMPERATURE SENSOR	THROTTLE ANGLE SENSOR	CYL SENSOR	INTAKE AIR TEMPERATURE SENSOR
PAGE									
SYMPTOM		117	120,122,124	126,130	132	136	138	140	142
CHECK ENGINE WARNING LIGHT TURNS ON		 or 							
SELF-DIAGNOSIS INDICATOR (LED) BLINKS		① or *	① or ④ or ⑬	③ or ⑤	④ or ⑧	⑥	⑦	⑨	⑩
ENGINE WON'T START		③			③			③	
DIFFICULT TO START ENGINE WHEN COLD		BU		③	③	①		③	
IRREGULAR IDLING	WHEN COLD FAST IDLE OUT OF SPECIFIC	BU				③			
	ROUGH IDLE	BU		③					
	WHEN WARM IDLE SPEED TOO HIGH	BU				③			
	WHEN WARM IDLE SPEED TOO LOW	BU							
FREQUENT STALLING	WHILE WARMING UP	BU				③			
	AFTER WARMING UP	BU							
POOR PERFORMANCE	MISFIRE OR ROUGH RUNNING	BU			③			③	
	FAILS EMISSION TEST	BU	③	②					
	LOSS OF POWER	BU		③			②		

- If codes other than those listed above are indicated, count the number of blinks again. If the indicator is in fact blinking these codes, substitute a known-good ECU and recheck. If the indication goes away, replace the original ECU.
 (BU): When the Check Engine warning light and the self-diagnosis indicator are on, the back-up system is in operation. Substitute a known-good ECU and recheck. If the indication goes away, replace the original ECU.



PGM-FI			IDLE CONTROL		FUEL SUPPLY		AIR INTAKE	EMISSION CONTROL	
ATMO-SPHERIC PRESSURE SENSOR	IGNITION OUTPUT SIGNAL	VEHICLE SPEED SENSOR	ELECTRONIC AIR CONTROL VALVE	OTHER IDLE CONTROLS	FUEL INJECTOR	OTHER FUEL SUPPLY		EGR CONTROL SYSTEM	OTHER EMISSION CONTROLS
144	146	148	155	150	168	167	172	179	178
⑬	⑮	⑰	⑭		⑯			⑫	
	①				②	③			
③				②					
			①	②					
			①		②			③	
			①	②					
			①		②				
			①	②		③			
③			③	①		②		③	
			③		①			③	
					②	③			①
					③	①	③		③

Troubleshooting

Self-diagnostic Procedure

When the Check Engine warning light has been reported on, turn the ignition on, pull down the passenger's side carpet from under the dashboard and observe the LED on the top of the ECU. The LED indicates a system failure code by blinking frequency. The ECU LED can indicate any number of simultaneous component problems by blinking separate codes, one after another. Problem codes 1 through 9 are indicated by individual short blinks. Problem codes 10 through 43 are indicated by a series of long and short blinks. One long blink equals 10 short blinks. Add the long and short blinks together to determine the problem code.

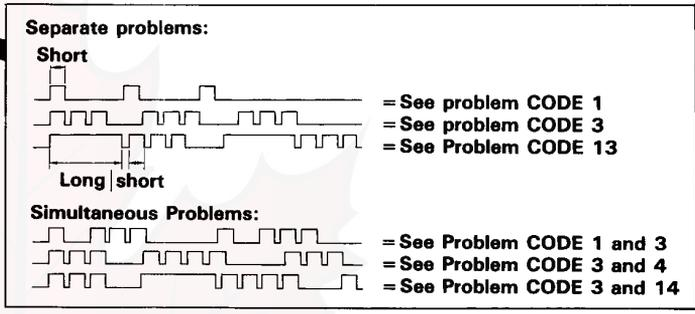
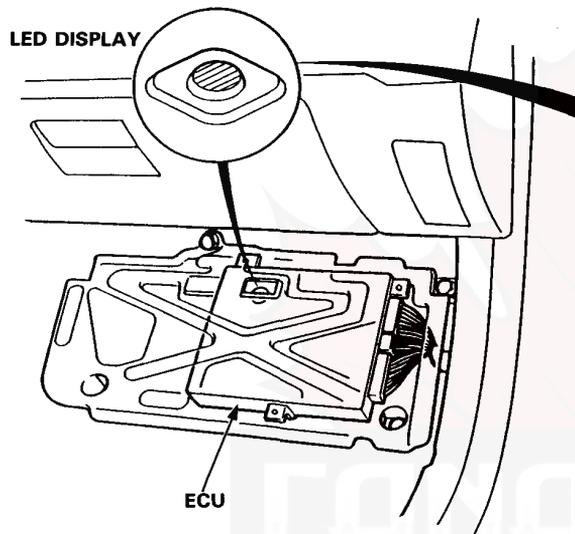

When the two terminals of the service check connector are connected with jumper wire the LED on the ECU and, the check engine warning light will indicate the same code.

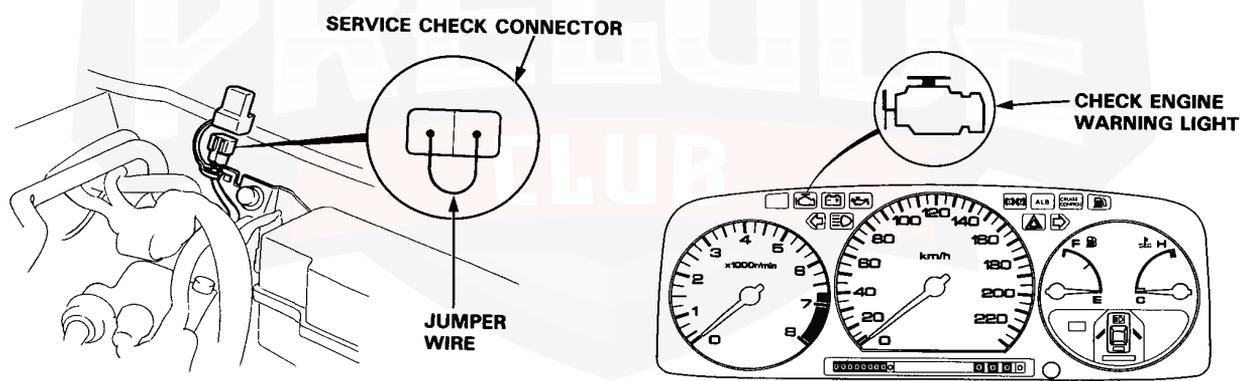

NOTE: If the Service Check Connector is jumped the Check Engine warning light will stay on.

After making the repair, disconnect the CLOCK fuse (10A) from the under-hood relay box for 10 seconds to reset ECU.
NOTE: Disconnecting the CLOCK fuse also cancels the radio preset stations and the clock setting. Make note of the radio presets before removing the fuse so you can reset them.



SELF-DIAGNOSIS INDICATOR BLINKS	SYSTEM INDICATED	PAGE
0	ECU	6-117
1	OXYGEN CONTENT	6-120
3	MANIFOLD ABSOLUTE PRESSURE	6-126
5		6-130
4	CRANK ANGLE	6-132
6	COOLANT TEMPERATURE	6-136
7	THROTTLE ANGLE	6-138
8	TDC POSITION	6-134
9	No. 1 CYLINDER POSITION	6-140
10	INTAKE AIR TEMPERATURE	6-142
12	EXHAUST GAS RECIRCULATION SYSTEM	6-179
13	ATMOSPHERIC PRESSURE	6-144
14	ELECTRONIC AIR CONTROL	6-155
15	IGNITION OUTPUT SIGNAL	6-146
16	FUEL INJECTOR	6-168
17	VEHICLE SPEED SENSOR	6-148
41	OXYGEN SENSOR HEATER	6-122
43	FUEL SUPPLY SYSTEM	6-124

- If codes other than those listed above are indicated, verify the code. If the code indicated is not listed above, replace the ECU.
- The Check Engine warning light may come on, indicating a system problem, when, in fact, there is a poor or intermittent electrical connection. First, check the electrical connections, clean or repair connections if necessary.
- The Check Engine warning light and S warning light may light simultaneously when the self-diagnosis indicator blinks 6, 7 and 17. Check the PGM-FI system according to the PGM-FI control system troubleshooting, then recheck the S warning light. If it lights, see page 9-31.

(cont'd)

Troubleshooting

Self-diagnostic Procedure (cont'd)

If the inspection for a particular failure code requires the ECU test harness, remove the right door sill molding, the small cover on the right kick panel, and pull the carpet back to expose the ECU. Unbolt the ECU bracket. Connect the ECU test harness. Then check the system according to the procedure described for the appropriate code(s) listed on the following pages.

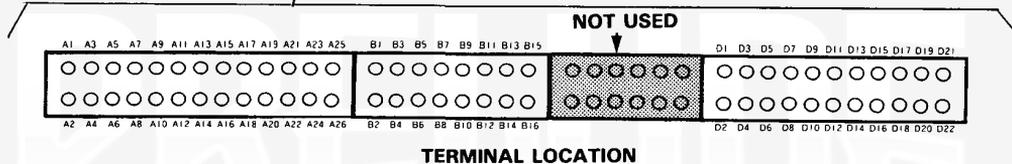
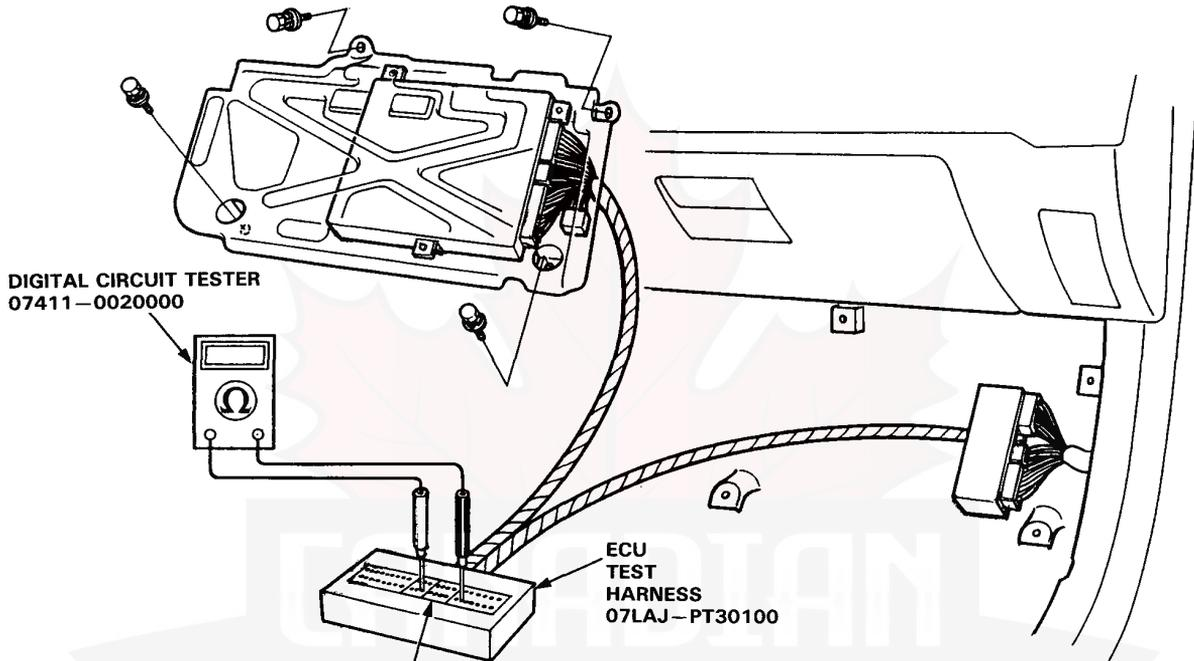

CAUTION:

- Puncturing the insulation on a wire can cause poor or intermittent electrical connections.
- For testing at connectors other than the ECU test harness, bring the tester probe into contact with the terminal from the connector side of wire harness connectors in the engine compartment. For female connectors, just touch lightly with the tester probe and do not insert the probe.

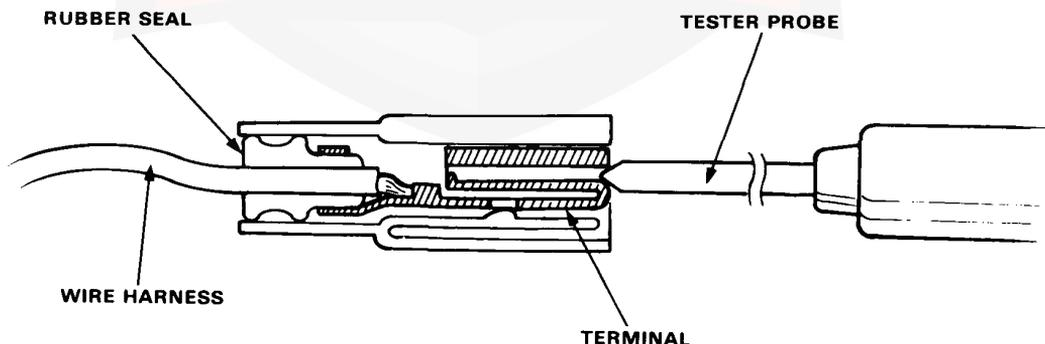

PGM-FI Control System



Troubleshooting Flowchart — ECU

Check Engine warning light isn't on for two seconds after ignition is first turned on.

Is oil pressure warning light on?

YES

Turn the ignition switch OFF.

Connect the ECU test harness between the ECU and connector (page 6-116).

Connect A13 terminal to body ground.

Turn the ignition switch ON.

Is Check Engine warning light on?

YES

Measure voltage between body ground and the following terminals individually to: •A23, •A24, •A26, •B2

Is there less than 1V?

YES

Substitute a known-good ECU and recheck. If symptom/ indication goes away, replace the original ECU.

Is No. 13 fuse OK?

Is No. 13 fuse OK?

NO

Replace fuse.

YES

Repair open in YEL wire between No. 13 fuse and combination meter.

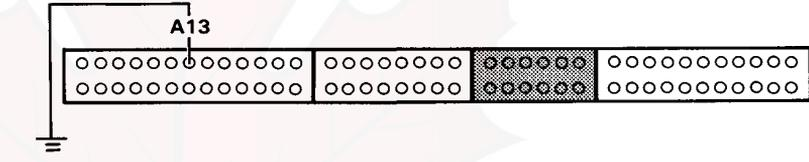

— Replace warning light bulb.
— Repair open in YEL/RED wire between ECU (A13) and combination meter.

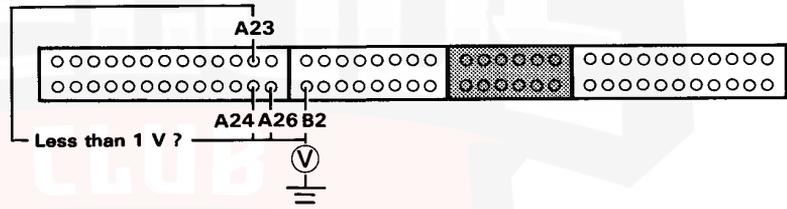

Repair open in wire between ECU and thermostat housing (G101) that had more than 1V.

(cont'd)

PGM-FI Control System

Troubleshooting Flowchart ECU (cont'd)

NOTE: If the Service Check Connector is jumped the check Engine warning light will stay on.

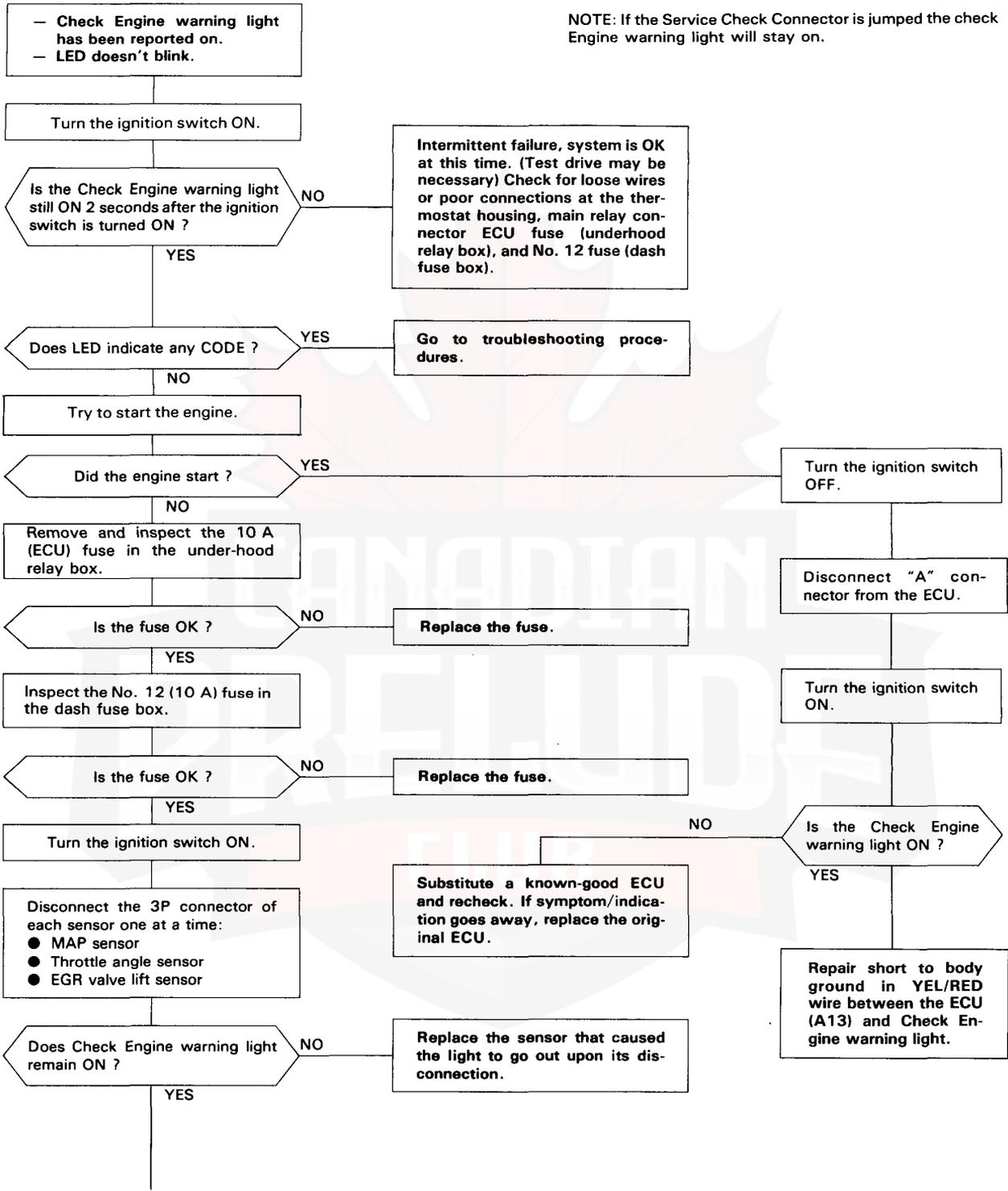

(To page 6-119)



(From page 6-118)

Turn the ignition switch OFF.

Connect the ECU test harness (page 6-116). Disconnect the "D" connector from the ECU only, not the main wire harness.

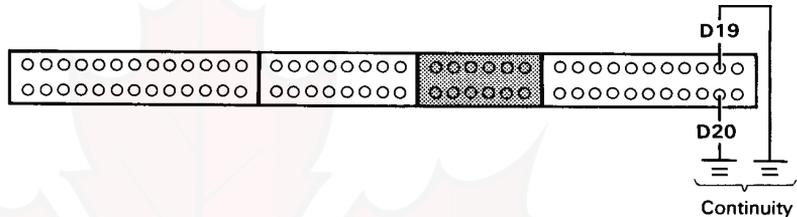

Check for continuity between body ground and the following terminals; D19, D20.

Does continuity exist ?

YES

Repair short to body ground in RED/WHT wire between ECU (D19, D20) and throttle angle sensor, EGR valve lift sensor and MAP sensor.

NO

Reconnect all the connectors. Reconnect the "D" connector to the ECU.

Turn the ignition switch ON.

Individually connect the following terminal to body ground: B2 • A26

Is the Check Engine warning light still ON after 2 seconds ?

NO

- Repair open in BLK/RED wire between ECU (A26) and G101.
- Repair open in BRN/BLK wire between ECU (B2) and G101.

YES

Measure voltage between A26 (-) and the following: B1 (+) and A25 (+).

Is there battery voltage ?

NO

- Repair open in YEL/BLK wire between ECU (A25, B1) and main relay.
- Check main relay and wiring connectors at main relay.

YES

Substitute a known-good ECU and recheck. If symptom/indication goes away, replace the original ECU.

PGM-FI Control System

Troubleshooting Flowchart — Oxygen Sensor

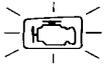

Self-diagnosis LED indicates code 1: A problem in the Heated Oxygen (O₂) Sensor circuit.



- Check Engine warning light has been reported on.
- LED indicates CODE 1.

Turn the ignition switch OFF.

Remove CLOCK fuse in the under-hood relay box for 10 seconds to reset ECU.

Warm up engine to normal operating temperature (cooling fan comes on).

Run engine for 60 seconds.

Road test with the transmission in 2nd gear, accelerate using wide open throttle for at least 5 seconds. Then decelerate for at least 5 seconds with the throttle completely closed.

Is Check Engine warning light on and does LED indicate CODE 1?

NO

Intermittent failure, system is OK at this time. Check for poor connections or loose wires at C236 (located at right shock tower) and at the O₂ sensor.

YES

Go to page 6-124 and perform test for CODE 43.



PGM-FI Control System

Troubleshooting Flowchart — Oxygen Sensor Heater

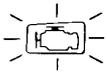

Self-diagnosis LED indicates code 41: A problem in the Oxygen (O₂) Sensor Heater circuit.

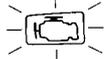

- Engine is running.
- Check Engine warning light has been reported on.
- LED indicates CODE 41.

Turn the ignition switch OFF.

Remove CLOCK fuse in the under-hood relay box for 10 seconds to reset ECU.

Start the engine

Is Check Engine warning light on and does LED indicate CODE 41 ?

NO

Intermittent failure, system is OK at this time (test drive may be necessary). Check for poor connections or loose wires at O₂ sensor, C236 (located at right shock tower), and ECU.

YES

Stop the engine

Disconnect the 4P connector from the O₂ sensor.

Measure resistance between terminals A and B on the O₂ sensor.

Is there 15–40 Ω?

NO

Replace O₂ sensor.

YES

Check for continuity to body ground on each terminal on the O₂ sensor.

Does continuity exist ?

YES

Replace O₂ sensor.

NO

Check for continuity between terminal A and terminals C and D individually.

Does continuity exist ?

YES

Replace O₂ sensor.

NO

(To page 6-123)

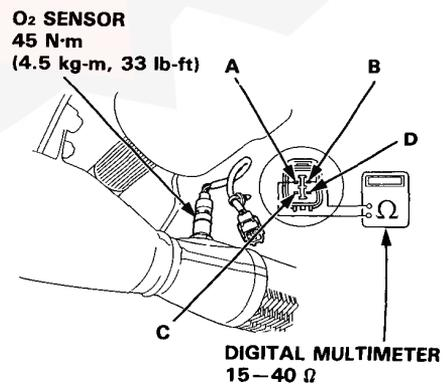



(From page 6-122)

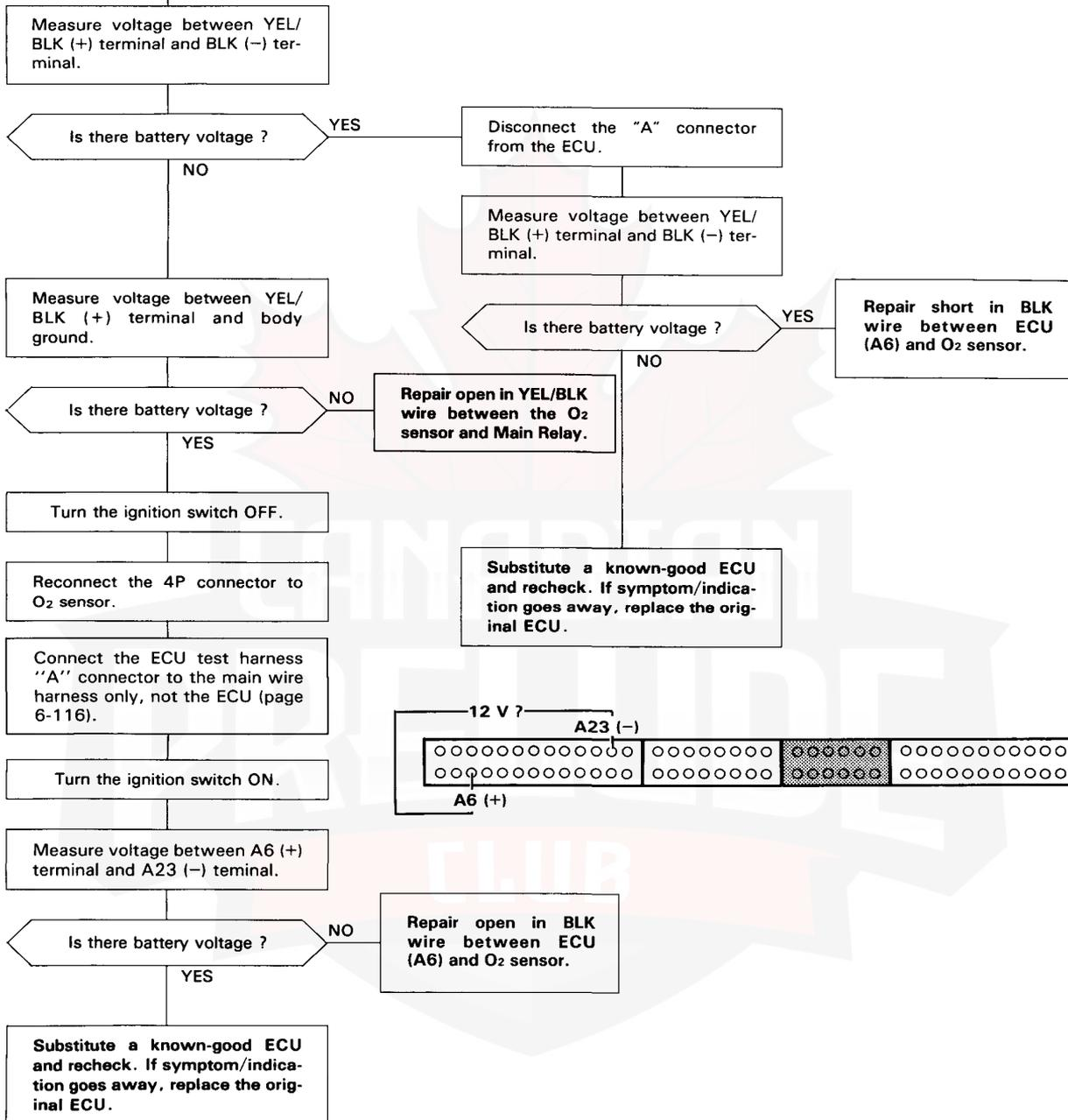

PGM-FI Control System

Troubleshooting Flowchart — Fuel Supply System

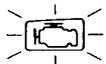

Self-diagnosis LED indicates code 43: Most likely a problem in the Oxygen (O₂) Sensor circuit or a problem in the Fuel Supply System.

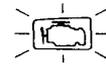

NOTE: If 43 code is accompanied by the check engine warning light and poor driveability, go to Fuel Supply System.

— Check Engine warning light has been reported on.
 — LED indicates CODE 43.
 — or continued from code 1.

Turn the ignition switch OFF.

Remove CLOCK fuse in the under-hood relay box for 10 seconds to reset ECU.

Warm up engine to normal operating temperature (cooling fan comes on).

Hold engine at 3,000 min⁻¹ (rpm) for 2 minutes.
 (A/T: Transmission is **N** or **P**.)

Is the Check Engine warning light on and does LED indicate CODE 43?

NO

**Intermittent failure, system is OK at this time (test drive may be necessary).
 Check for poor connections or loose wires at O₂ sensor C236 (located at right shock tower), and ECU.**

YES

Turn the ignition switch OFF.

Connect the ECU test harness between the ECU and connector (page 6-116).

With the ignition switch OFF, wait for at least two minutes.

Turn the ignition switch ON.

Measure voltage between D14 (+) terminal and A26 (-) terminal as soon as the ignition switch is turned on.

NOTE

- Use DIGITAL CIRCUIT TESTER (07411-0020000) or equivalent.
- Use 2 Volt range.

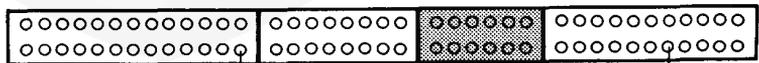

A26 (-)

D14 (+)

Voltage should start at 0.4–0.5 V when the ignition switch is first turned on, and decrease to below 0.1 V in less than two minutes.

(To page 6-125)



(From page 6-124)

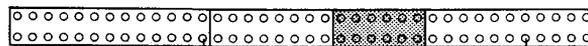

A26 (-) D14 (+)
Voltage should start at 0.4–0.5 V when the ignition switch is first turned on, and decrease to below 0.1 V in less than two minutes.

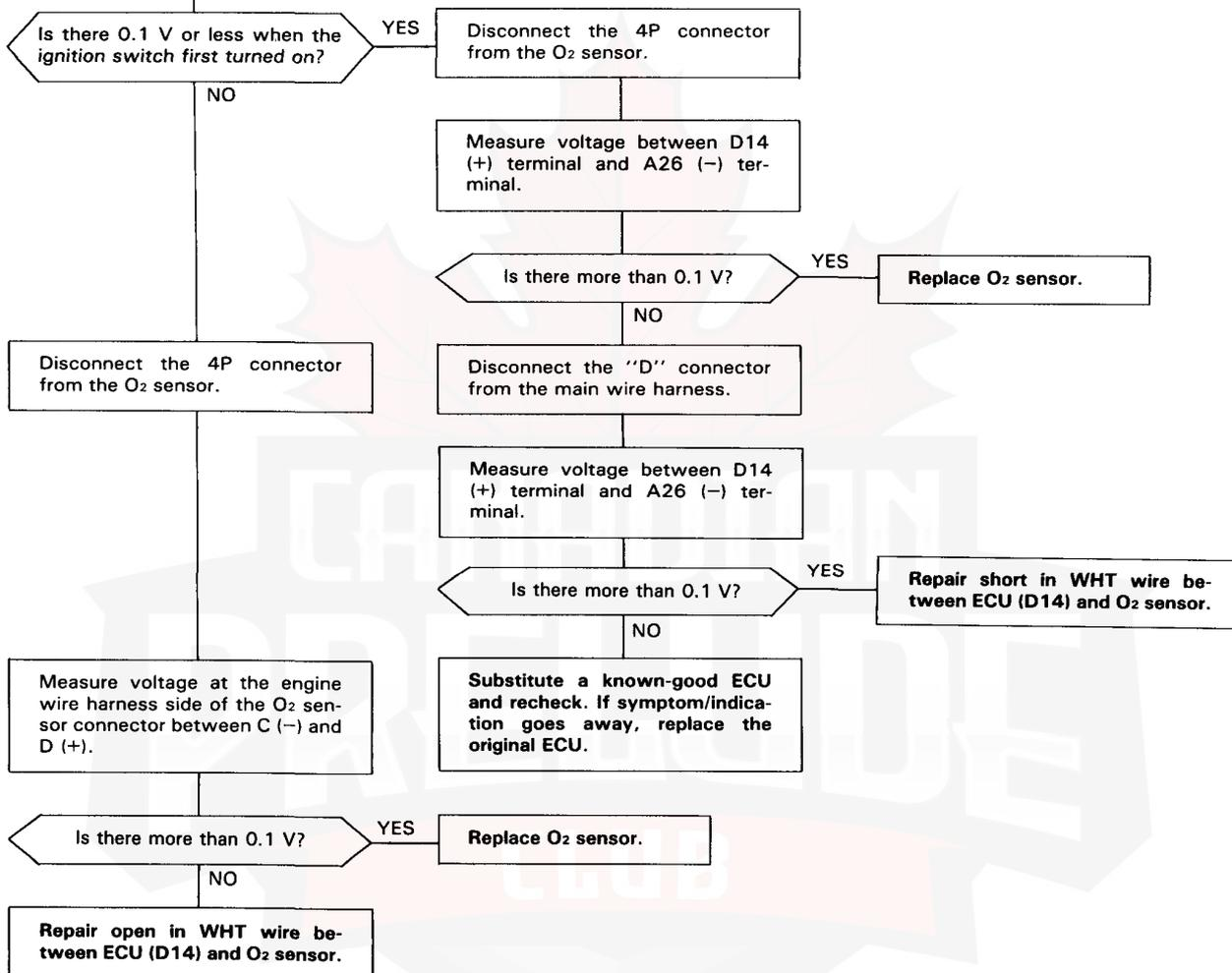

Engine Wire Harness side of the O₂ sensor connector

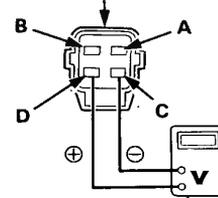

DIGITAL MULTIMETER
KS-AHM-32-003

PGM-FI Control System

Troubleshooting Flowchart — MAP Sensor

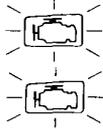

Self-diagnosis LED indicates code 3: Most likely an electrical problem in the Manifold Absolute Pressure (MAP) Sensor system.

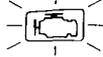

Self-diagnosis LED indicates code 5: Most likely a mechanical problem (broken hose) in the Manifold Absolute Pressure (MAP) Sensor System.



- Engine is warm and running.
- Check Engine warning light has been reported on.
- LED indicates CODE 3.

Turn the ignition switch OFF.

Remove CLOCK fuse in the under-hood relay box for 10 seconds to reset ECU.

Warm up engine to normal operating temperature (cooling fan comes on).

Is Check Engine warning light on and does LED indicate CODE 3?

NO

YES

Intermittent failure, system is OK at this time (test drive may be necessary).
Check for poor connection or loose wires at MAP sensor connector and ECU.

Turn the ignition switch OFF.

Disconnect the 3P connector from the MAP sensor.

Turn the ignition switch ON.

Measure voltage between RED/WHT (+) terminal and body ground.

(To page 6-127)

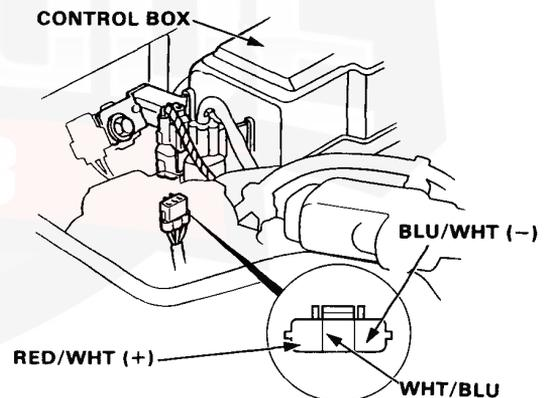

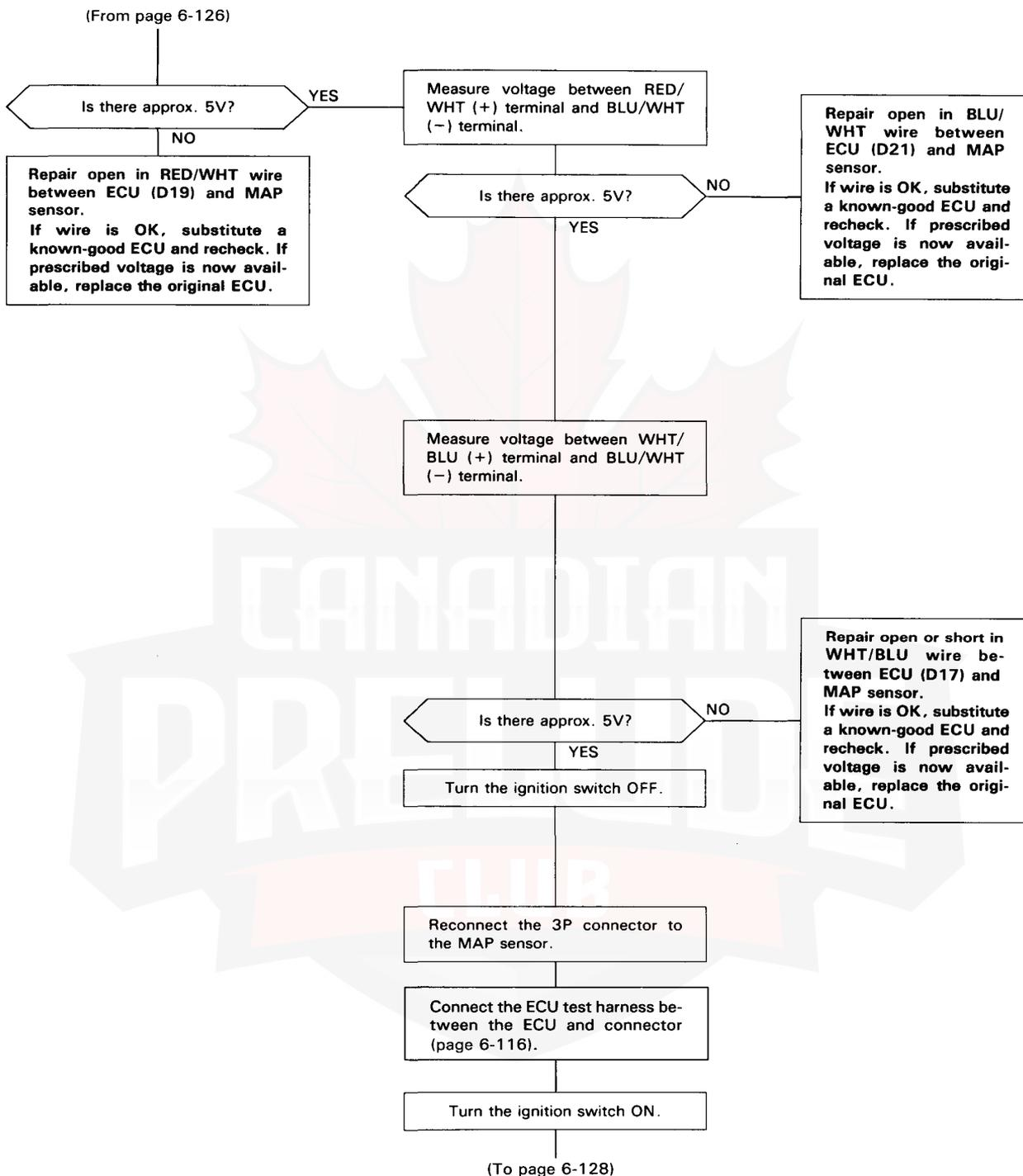

(cont'd)

PGM-FI Control System

Troubleshooting Flowchart — MAP Sensor (cont'd)

(From page 6-127)

Measure voltage between D17 (+) terminal and D21 (-) terminal.

3 V ?
D17 (+) D21 (-)

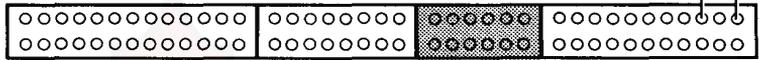

Is there approx. 3 V ?

NO

Replace MAP sensor.

YES

Substitute a known-good ECU and recheck. If symptom/indication goes away, replace the original ECU.





PGM-FI Control System

Troubleshooting Flowchart — MAP Sensor



- Check Engine warning light has been reported on.
- LED indicates CODE 5.

Turn the ignition switch OFF.

Remove CLOCK fuse in the under-hood relay box for 10 seconds to reset ECU.

Start the engine.

Is Check Engine warning light on and does LED indicate CODE 5?

YES

Stop the engine.

Disconnect #21 hose from the throttle body, connect vacuum pump to the hose and apply vacuum.

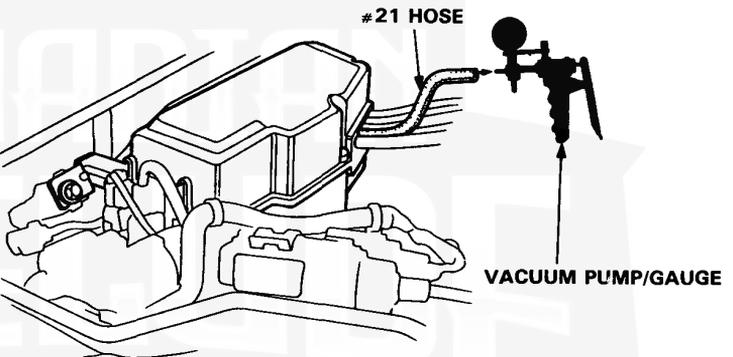

- Intermittent failure, system is OK at this time (test drive may be necessary).
- Check vacuum hoses, pipes and connections.
- Make sure all connectors are secure.

Does it hold vacuum?

YES

Connect a T-fitting from a vacuum gauge between the throttle body and MAP sensor.

Connect a vacuum pump to the MAP sensor and apply vacuum.

Does it hold vacuum?

YES

Replace #21 hose.

Replace MAP sensor.

(To page 6-131)



(From page 6-130)

Start the engine.

Is there manifold vacuum?

NO

-Remove restriction from throttle body.
-Replace throttle body.

YES

Stop the engine.

Connect the ECU test harness between the ECU and connector (page 6-116).

Turn the ignition switch ON.

Measure voltage between D17 (+) terminal and D21 (-) terminal.



Is there approx. 3 V ?

NO

Replace the MAP sensor.

YES

Start the engine and allow it to idle.

Is there approx. 1 V ?

NO

Replace MAP sensor.

YES

Substitute a known-good ECU and recheck. If symptom/indication goes away, replace the original ECU.

PGM-FI Control System

Troubleshooting Flow Chart — TDC/CRANK Sensor

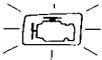

Self-diagnosis LED indicates code 4: A problem in the CRANK circuit of the TDC/CRANK Sensor.

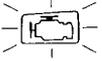

Self-diagnosis LED indicates code 8: A problem in the TDC circuit of the TDC/CRANK Sensor.



- Check Engine warning light has been reported on.
- LED indicates CODE 4.

Turn the ignition switch OFF.

Remove CLOCK fuse in the under-hood relay box for 10 seconds to reset ECU.

Start the engine.

Is Check Engine warning light on and does LED indicate CODE 4 ?

NO

YES

Stop engine.

Disconnect the 4P connector from the TDC/CRANK sensor.

Measure resistance between C terminal and D terminal.

Is there 700–1,000 Ω ?

NO

YES

Replace pulse generator assembly (section 16).

Intermittent failure, system is OK at this time (test drive may be necessary).
Check for poor connections or loose wires at distributor connector and C236 (located at right shock tower).

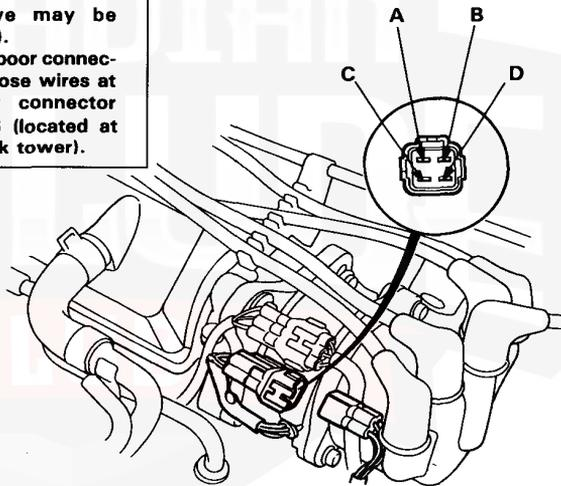

(To page 6-133)



(From page 6-132)

Check for continuity to body ground on C terminal and D terminal individually.

Does continuity exist? YES **Replace pulse generator assembly (section 16).**

NO

Reconnect the connector.

Connect the ECU test harness only to the main wire harness, but not to the ECU (page 6-116).

Measure resistance between B15 terminal and B16 terminal.

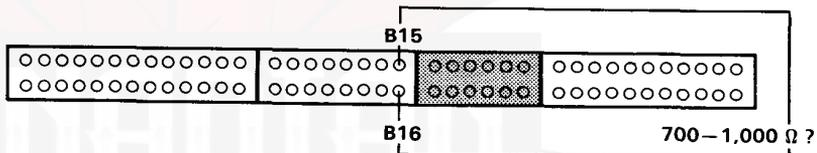

Is there 700-1,000 Ω? NO **Repair open in BLU/YEL and/or BLU/GRN wires.**

YES

Check for continuity to body ground on B15 terminal.

Does continuity exist? YES **Repair short in BLU/GRN wire between ECU (B15) and distributor connector.**

NO

Substitute a known-good ECU and recheck. If symptom/indication goes away, replace the original ECU.

(cont'd)

PGM-FI Control System

Troubleshooting Flow Chart — TDC/CRANK sensor (cont'd)

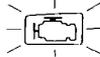

- Check Engine warning light has been reported on.
- LED indicates CODE 8.

Turn the ignition switch OFF.

Remove CLOCK fuse in the under-hood relay box for 10 seconds to reset ECU.

Start engine.

Is Check Engine warning light on and does LED indicate CODE 8 ?

NO

YES

Stop engine.

Disconnect the 4P connector from the TDC/CRANK sensor.

Measure resistance between A terminal and B terminal.

Is there 700—1,000 Ω ?

NO

YES

Check for continuity to body ground on A terminal and B terminal individually.

Does continuity exist ?

YES

NO

Reconnect the connector.

(To page 6-135)

Intermittent failure, system is OK at this time (test drive may be necessary).
Check for poor connections or loose wires at distributor connector and C236 (located at right shock tower).

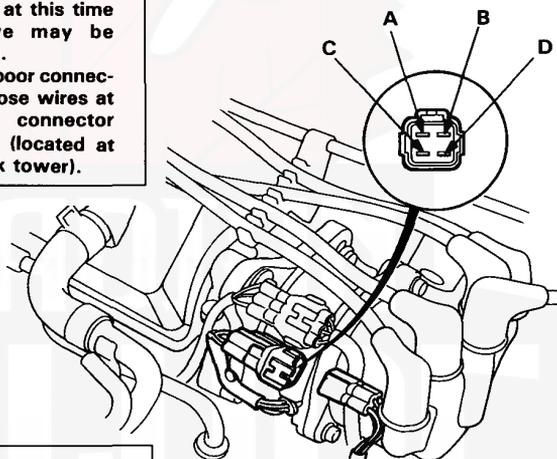

Replace pulse generator assembly (Section 16).

Replace pulse generator assembly (Section 16).



(From page 6-134)

Connect the ECU test harness only to the main wire harness, but not to the ECU (page 6-116).

Measure resistance between B13 terminal and B14 terminal.

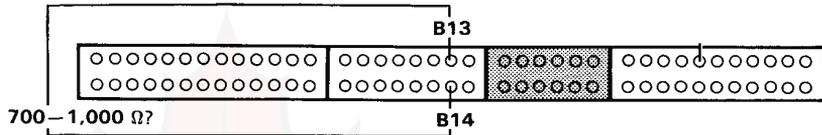

Is there 700 — 1,000 Ω ?

NO

Repair open in ORN/BLU and/or WHT/BLU wires between the ECU and distributor connector.

YES

Check for continuity to body ground on B13 terminal.

Does continuity exist?

YES

Repair short in ORN/BLU wire between ECU (B13) and distributor connector.

NO

Substitute a known-good ECU and recheck. If symptom/indication goes away, replace the original ECU.

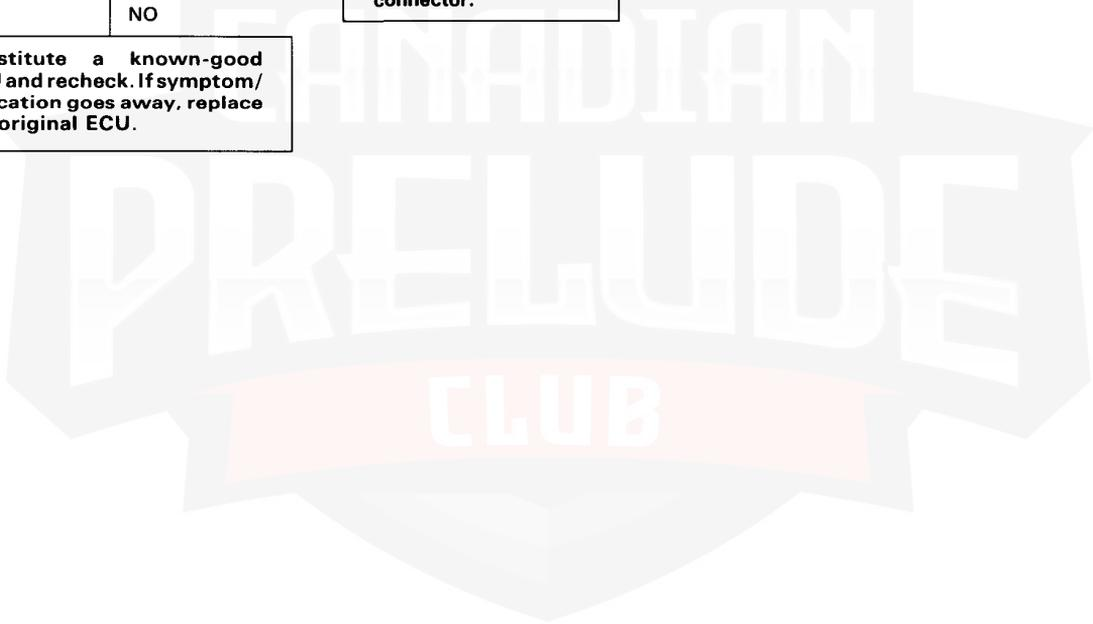

PGM-FI Control System

Troubleshooting Flowchart — TW Sensor

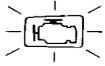

Self-diagnosis LED indicates code 6: Most likely a problem in the Coolant Temperature (TW) Sensor circuit.



- Check Engine warning light has been reported on.
- LED indicates CODE 6.

Turn the ignition switch OFF.

Remove CLOCK fuse in the under-hood relay box for 10 seconds to reset ECU.

Turn the ignition switch ON.

Is Check Engine warning light on and does LED indicate CODE 6?

NO

YES

Intermittent failure, system is OK at this time (test drive may be necessary).

Check for poor connections or loose wires at TW sensor and C235 (located at right shock tower).

Warm up engine to normal operating temperature (cooling fan comes on).

Turn the ignition switch OFF.

Disconnect the 2P connector from the TW sensor.

Measure resistance between the 2 terminals on the TW sensor.

Is there 200—400 Ω ?

NO

YES

Replace TW sensor.

Turn the ignition switch ON.

Measure voltage between YEL/GRN and body ground.

(To page 6-137)

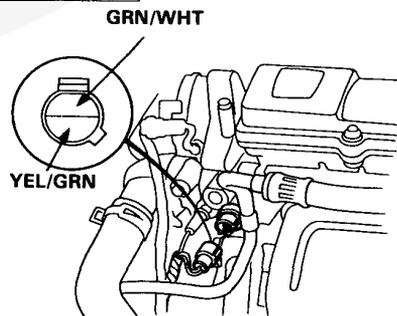



(From page 6-136)

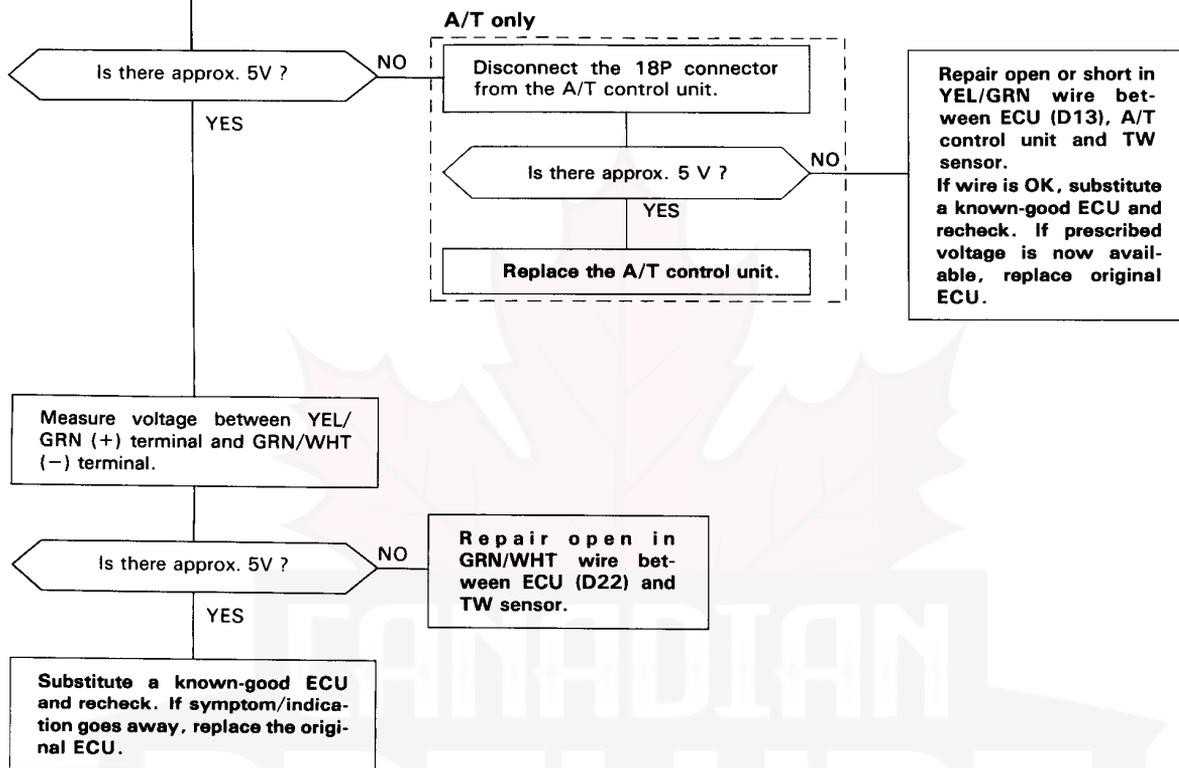

PGM-FI Control System

Troubleshooting Flowchart — Throttle Angle Sensor

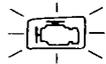

Self-diagnosis LED indicates code 7: Most likely a problem in the Throttle Angle Sensor circuit.

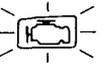

- Engine is running.
- Check Engine warning light has been reported on.
- LED indicates CODE 7.

Turn the ignition switch OFF.

Remove CLOCK fuse in the under-hood relay box for 10 seconds to reset ECU.

Start the engine.

Is Check Engine warning light on and does LED indicate CODE 7?

NO

Intermittent failure, system is OK at this time (test drive may be necessary).
Check for poor connections or loose wires at throttle angle sensor and C235 (located at right shock tower).

Turn the ignition switch OFF.

Disconnect the 3P connector from the throttle angle sensor.

Turn the ignition switch ON.

Measure voltage between YEL/WHT (+) terminal and GRN/WHT (-) terminal.

Is there approx. 5V ?

NO

Measure voltage between YEL/WHT (+) terminal and body ground.

Is there approx. 5V ?

YES

Repair open in GRN/WHT wire between ECU (D22) and throttle angle sensor.

Turn the ignition switch OFF.

Reconnect the 3P connector.

Turn the ignition switch OFF.

(To page 6-139)

(To page 6-139)

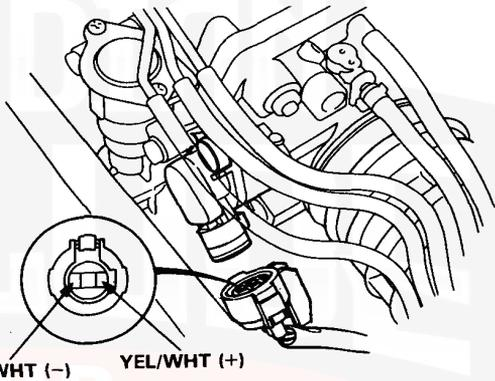

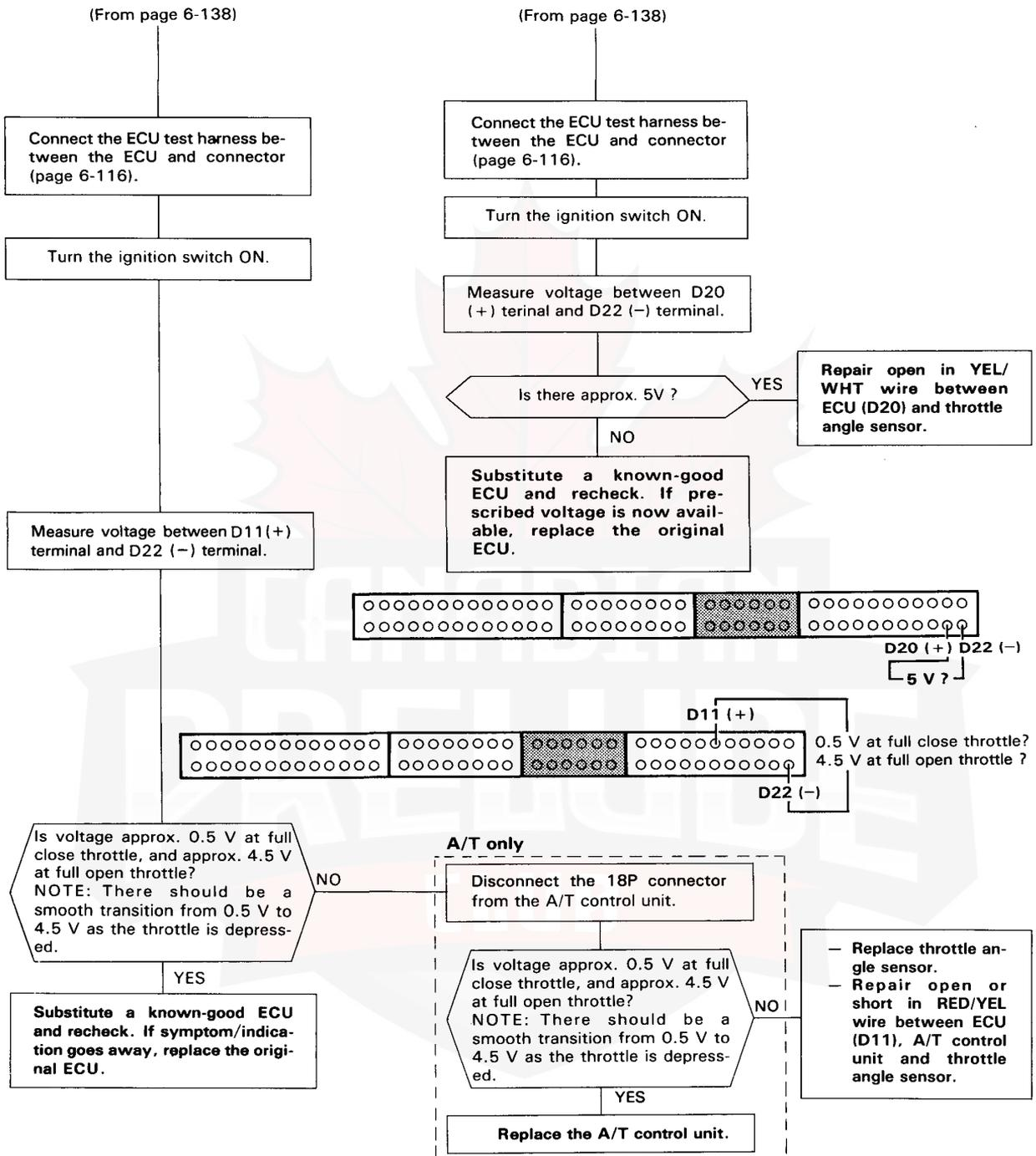

PGM-FI Control System

Troubleshooting Flowchart — CYL Sensor

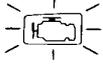

Self-diagnosis LED indicates code 15: A problem in the CYL sensor.

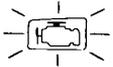

- Check Engine warning light has been reported on.
- LED indicates CODE 9.

Turn the ignition switch OFF.

Remove CLOCK fuse in the under-hood relay box for 10 seconds to reset ECU.

Start the engine.

Is Check Engine warning light on and does LED indicate CODE 9 ?

NO

YES

Stop the engine.

Disconnect the 2P connector from the CYL sensor.

Measure resistance between 2 terminals on the CYL sensor.

Is there 700 – 1,100 Ω ?

NO

YES

Check for continuity to body ground on the 2 terminals individually.

(To page 6-141)

Intermittent failure, system is OK at this time (test drive may be necessary).
Check for poor connections or loose wires at CYL Sensor connector and C236 (located at right shock tower).

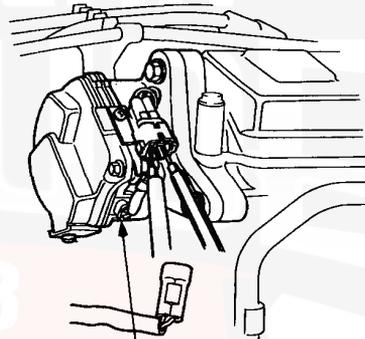

CYL SENSOR



(From page 6-140)

Does continuity exist? **YES** **Replace CYL sensor assembly (page 6-149).**

NO

Reconnect the connector.

Connect the PGM-FI test harness only to the main wire harness, but not the the ECU (page 6-116)

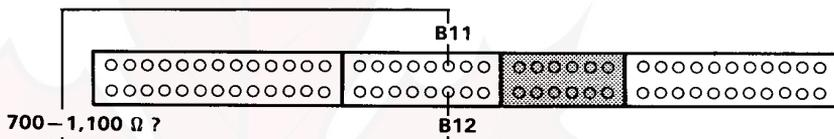

Measure resistance between B11 terminal and B12 terminal.

Is there 700-1,100 Ohms? **NO** **Repair open in ORN and/or WHT wires.**

YES

Check for continuity to body ground on B11 terminal.

Does continuity exist? **YES** **Repair short in ORN wire between ECU (B11) and CYL Sensor connector.**

NO

Substitute a known-good ECU and recheck. If symptom/indication goes away, replace the original ECU.

PGM-FI Control System

Troubleshooting Flowchart — TA Sensor

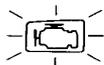

Self-diagnosis LED indicates code 10: Most likely a problem in the Intake Air Temperature (TA) Sensor circuit.

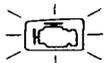

- Check Engine warning light has been reported on.
- LED indicates CODE 10.

Turn the ignition switch OFF.

Remove CLOCK fuse in the under-hood relay box for 10 seconds to reset ECU.

Turn the ignition switch ON.

Is Check Engine warning light on and does LED indicate CODE 10?

NO

YES

Intermittent failure, system is OK at this time (test drive may be necessary). Check for poor connections or loose wires at TA sensor and C235 (located at right shock tower).

Turn the ignition switch OFF.

Disconnect the 2P connector from the TA sensor.

Measure resistance between the 2 terminals on the TA sensor.

Is there 1-4 k Ω ?

NO

Replace TA sensor.

YES

Turn the ignition switch ON.

Measure voltage between WHT/RED (+) terminal and body ground.

TA SENSOR

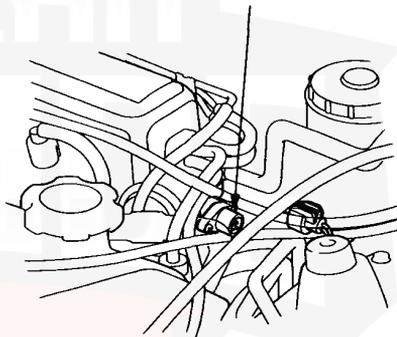

(To page 6-143)



(From page 6-142)

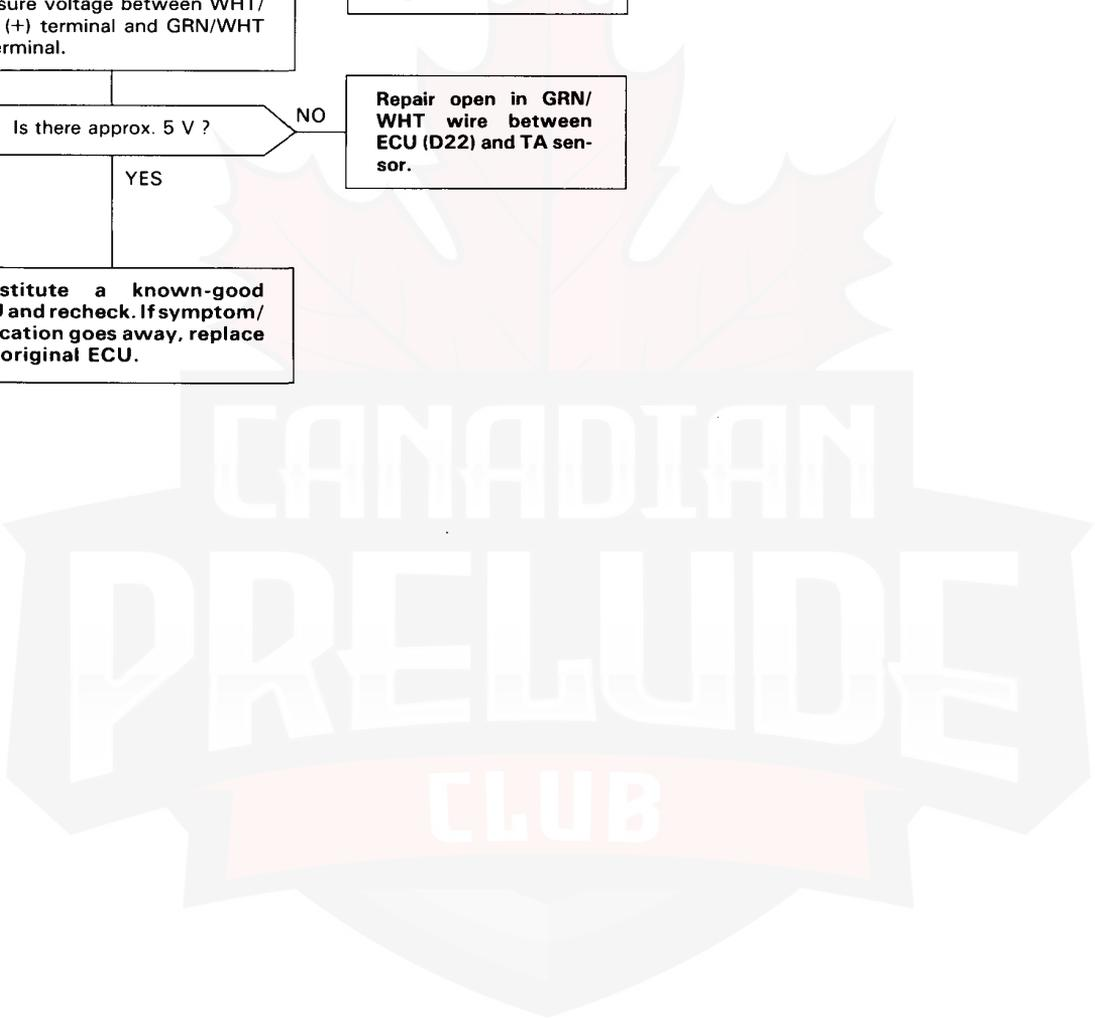
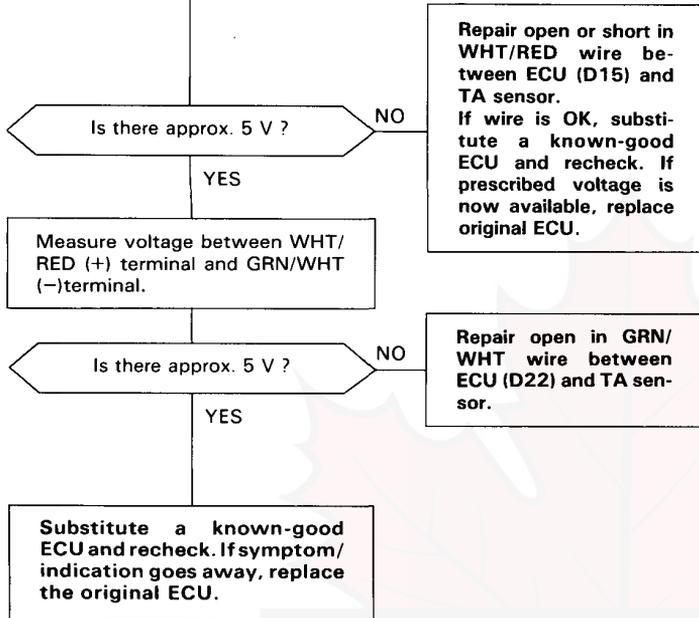

PGM- FI Control System

Troubleshooting Flowchart — PA Sensor



13

Self-diagnosis LED indicates code 13: A problem in the Atmospheric Pressure (PA) Sensor.

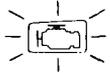

13

- Check Engine warning light has been reported on.
- LED indicates CODE 13.

NOTE:
The PA sensor is built into the ECU.

Turn the ignition switch OFF.

Remove CLOCK fuse in the under-hood relay box for 10 seconds to reset ECU.

Turn the ignition switch ON.

Is Check Engine warning light on and does LED indicate CODE 13 ?

NO

Intermittent failure, system is OK at this time (test drive may be necessary).

YES

Substitute a known-good ECU and recheck. If symptom/indication goes away, replace the original ECU.



PGM-FI Control System

Troubleshooting Flowchart — Ignition Output Signal



Self-diagnosis LED indicates code 15: A problem in the Ignition Output Signal circuit.

- Check Engine warning light has been reported on.
- LED indicates CODE 15.

Turn the ignition switch OFF.

Remove CLOCK fuse in the under-hood relay box for 10 seconds to reset ECU.

Turn the ignition switch to the Start Position.

Is Check Engine warning light on and does LED indicate CODE 15?

NO

**Intermittent failure, system is OK at this time (test drive may be necessary).
Check for poor connections or loose wires at the igniter unit connector.**

YES

Turn the ignition switch OFF.

Disconnect the 6P connector on the igniter unit.

Turn the ignition switch ON.

Measure voltage between the BLK/YEL (+) terminal and body ground.

Is there battery voltage ?

NO

Repair open in the BLK/YEL wire between the igniter unit and ignition switch.

YES

Turn the ignition switch OFF.

Connect the ECU test harness between the ECU and connector (page 6-116).

(To page 6-147)

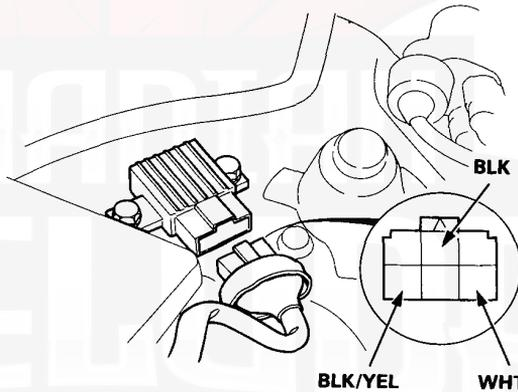



(From page 6-146)

Reconnect the 6P connector on the igniter unit.

Turn the ignition switch ON.

Measure voltage individually between A21 (+), A22 (+) terminals and A26 (-) terminal.

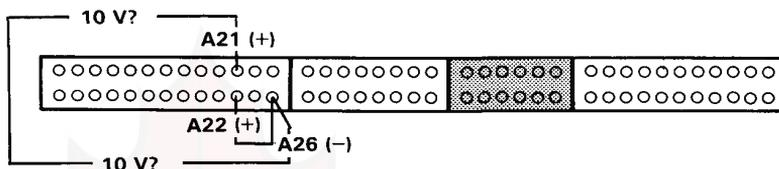

Is there approx. 10 V ?

NO

Turn the ignition switch OFF.

YES

Substitute a known-good ECU and recheck. If symptom/indication goes away, replace the original ECU.

Disconnect the 6P connector on the igniter unit and the system checker harness from the ECU.

Check for continuity of WHT wires between the ECU (A21, A22) and the igniter unit.

Does continuity exist ?

NO

Repair open in WHT wires between the ECU (A21, A22) and the igniter unit.

YES

Check for continuity between white terminal of 6P connector and body ground.

Does continuity exist ?

YES

Repair short in WHT wire.

NO

Replace the igniter unit.

NOTE: If the WHT wire was shorted, the igniter may be damaged.

PGM-FI Control System

Troubleshooting Flowchart — Vehicle Speed Sensor



Self-diagnosis LED indicates code 17: A problem in the Vehicle Speed Sensor circuit.

– Check Engine warning light has been reported on.
– LED indicates CODE 17.

Turn the ignition switch OFF.

Remove CLOCK fuse in the under-hood relay box for 10 seconds to reset ECU.

Road test necessary.
In 2nd gear accelerate to 3,500 min⁻¹ (rpm), then decelerate to 1,500 min⁻¹ (rpm) with throttle fully closed.

Is Check Engine warning light on and does LED indicate CODE 17?

NO

Intermittent failure, system is OK at this time.
Check for poor connections or loose wires at C129 and C240.

YES

Block rear wheels and set the parking brake. Jack up the front of the car and support with safety stands.

⚠ WARNING Block rear wheels before jacking up front of car.

Connect the ECU test harness between the ECU and connector (page 6-116).

Turn the ignition switch ON.

Slowly rotate left front wheel and measure voltage between B10 (+) terminal and A26 (-) terminal.

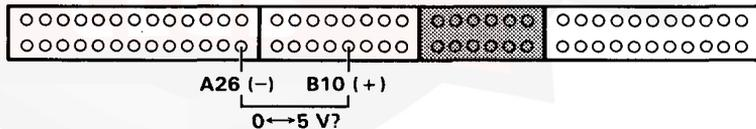

Does voltage pulse 0 V and 5 V?

NO

- Repair open or short in WHT/BLU wire between ECU (B10) and the speed sensor.
- Faulty speed sensor.
- Substitute a known-good ECU and recheck. IF symptom/indication goes away, replace the original ECU.

YES

Substitute a known-good ECU and recheck. If symptom/indication goes away, replace the original ECU.



CYL Sensor Assembly Replacement

Removal:

1. Remove the CYL sensor assembly from the engine.

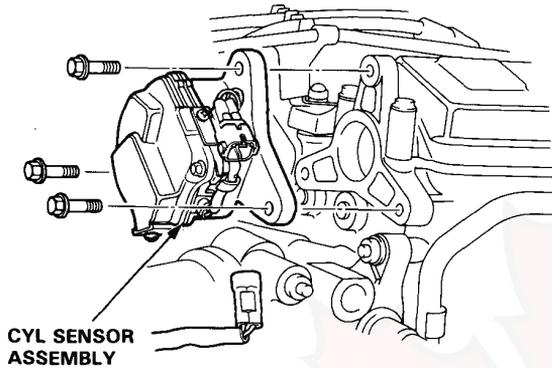

Installation:

1. Install a new O-ring on the sensor housing.
2. Slip the sensor assembly into the position.

NOTE: The lugs on the end of the sensor and its mating grooves in the camshaft end are both offset to eliminate the possibility of installing the sensor 180° out of time.

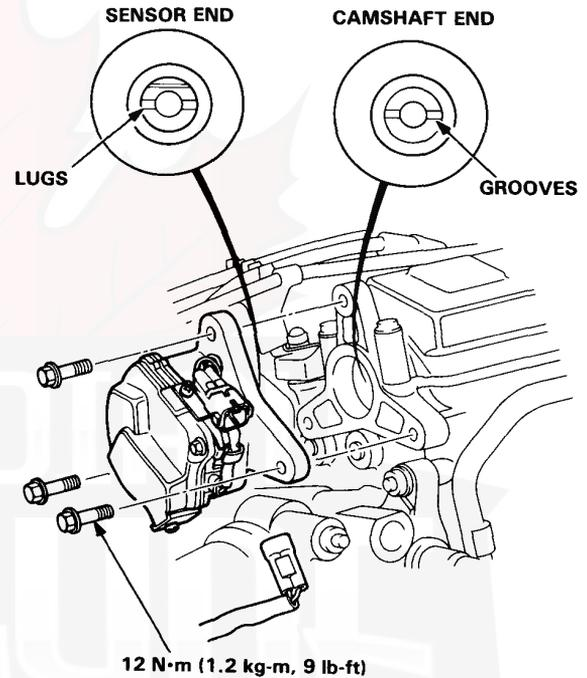

Idle Control System

System Troubleshooting Guide

NOTE:

- Across each row in the chart, the sub systems that could be sources of a symptom are ranked in the order they should be inspected, starting with ①. Find the symptom in the left column, read across to the most likely source, then refer to the page listed at the top of that column. If inspection shows the system is OK, try the next system ②, etc.
- If the idle speed is out of specification and LED does not blink CODE 14, go to inspection described on page 6-151.

SUB SYSTEM		IDLE ADJUSTING SCREW	EACV	AIR CONDITIONING SIGNAL	ALTERNATOR FR SIGNAL	A/T SHIFT POSITION SIGNAL (A/T ONLY)	STARTER SWITCH SIGNAL	P/S OIL PRESSURE SWITCH SIGNAL	FAST IDLE VALVE	HOSES AND CONNECTIONS
PAGE										
SYMPTOM		—	152, 155	158	160	162	164	165	—	*
DIFFICULT TO START ENGINE WHEN COLD									①	
WHEN COLD FAST IDLE OUT OF SPEC (1,000–2,000 min ⁻¹)		③	②						①	
ROUGH IDLE			②							①
WHEN WARM RPM TOO HIGH		③	①					③	②	③
WHEN WARM RPM TOO LOW	Idle speed is below specified rpm (no load)	②	①							
	Idle speed does not increase after initial start up		①							
	On models with automatic transmission, the idle speed drops in gear		②			①				
	Idle speeds drops when air conditioner in ON		②	①						
	Idle speed drops when steering wheel is turning		②					①		
	Idle speed fluctuates with electrical load		①							
FRE-QUENT STALLING	WHILE WARMING UP		①							
	AFTER WARMING UP	②	①							
FAILS EMISSION TEST										①



1. When the idle speed is out of specification and LED does not blink CODE 14, check the following items:
 - Adjust the idle speed (page 6-166)
 - Air conditioning signal (page 6-158)
 - Alternator FR signal (page 6-160)
 - A/T shift position signal (page 6-162)
 - Starter switch signal (page 6-164)
 - P/S oil pressure signal (page 6-165)
 - Fast idle valve
 - Hoses and connections
 - EACV and its mounting O-rings

2. If the above items are normal, substitute a known-good EACV and readjust the idle speed (page 6-166).
 - If the idle speed still cannot be adjusted to specification (and LED does not blink CODE 14) after EACV replacement, substitute a known-good ECU and recheck. If symptom goes away, replace the original ECU.

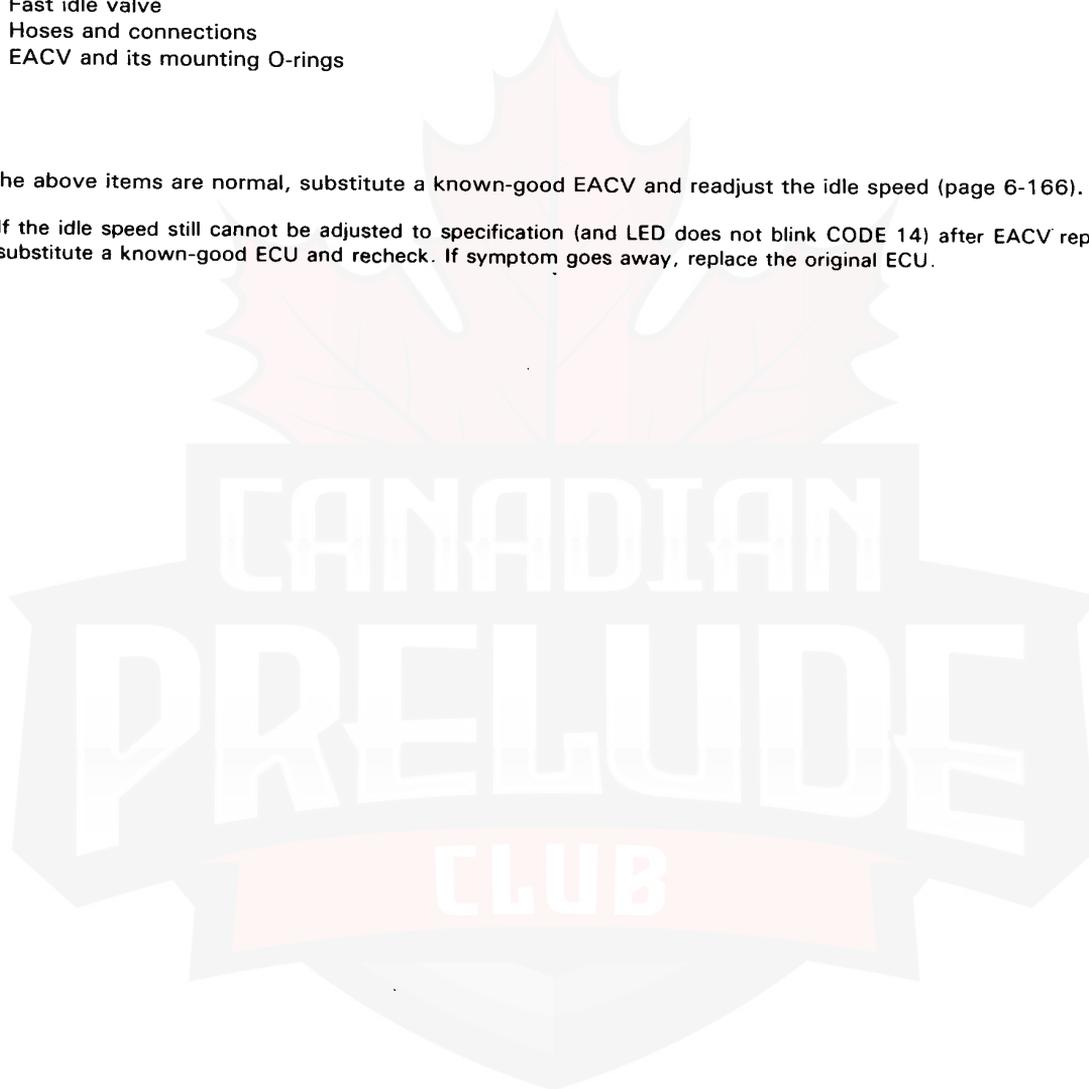

Idle Control System

Troubleshooting Flowchart — EACV [KF, KE, KB, KW, KT, KQ, KY]

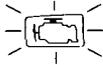

Self-diagnosis LED indicates code 14: A problem in the Electronic Air Control Valve (EACV) circuit.

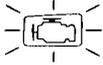

- Engine is running.
- Check Engine warning light is on.
- LED indicates CODE 14.

Turn the ignition switch OFF.

Remove CLOCK fuse in the dash fuse box for 10 seconds to reset ECU.

Start engine.

Is Check Engine warning light on and does LED indicate CODE 14?

NO

Intermittent failure, system is OK at this time (test driving may be necessary). Check for poor connections or loose wires at EACV and at C235 (located at right shock tower).

YES

Stop engine.

Disconnect the 2P connector from the EACV.

Measure resistance between the 2 terminals on the EACV.

Is there 8—15Ω ?

NO

Replace EACV.

YES

Check for continuity to body ground on each terminal on the EACV.

Does continuity exist ?

YES

Replace EACV

NO

(To page 6-153)

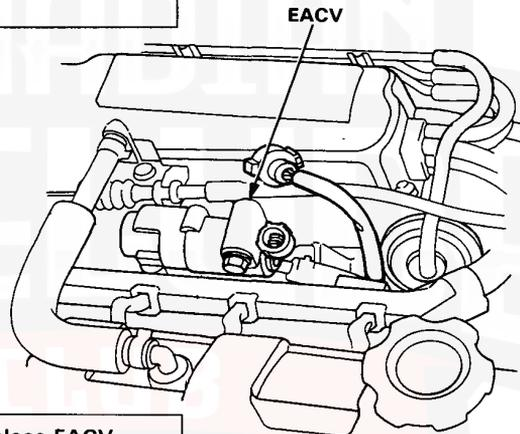



(From page 6-152)

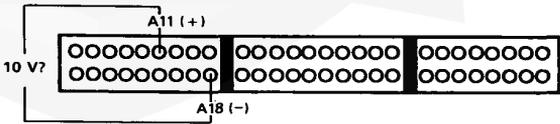
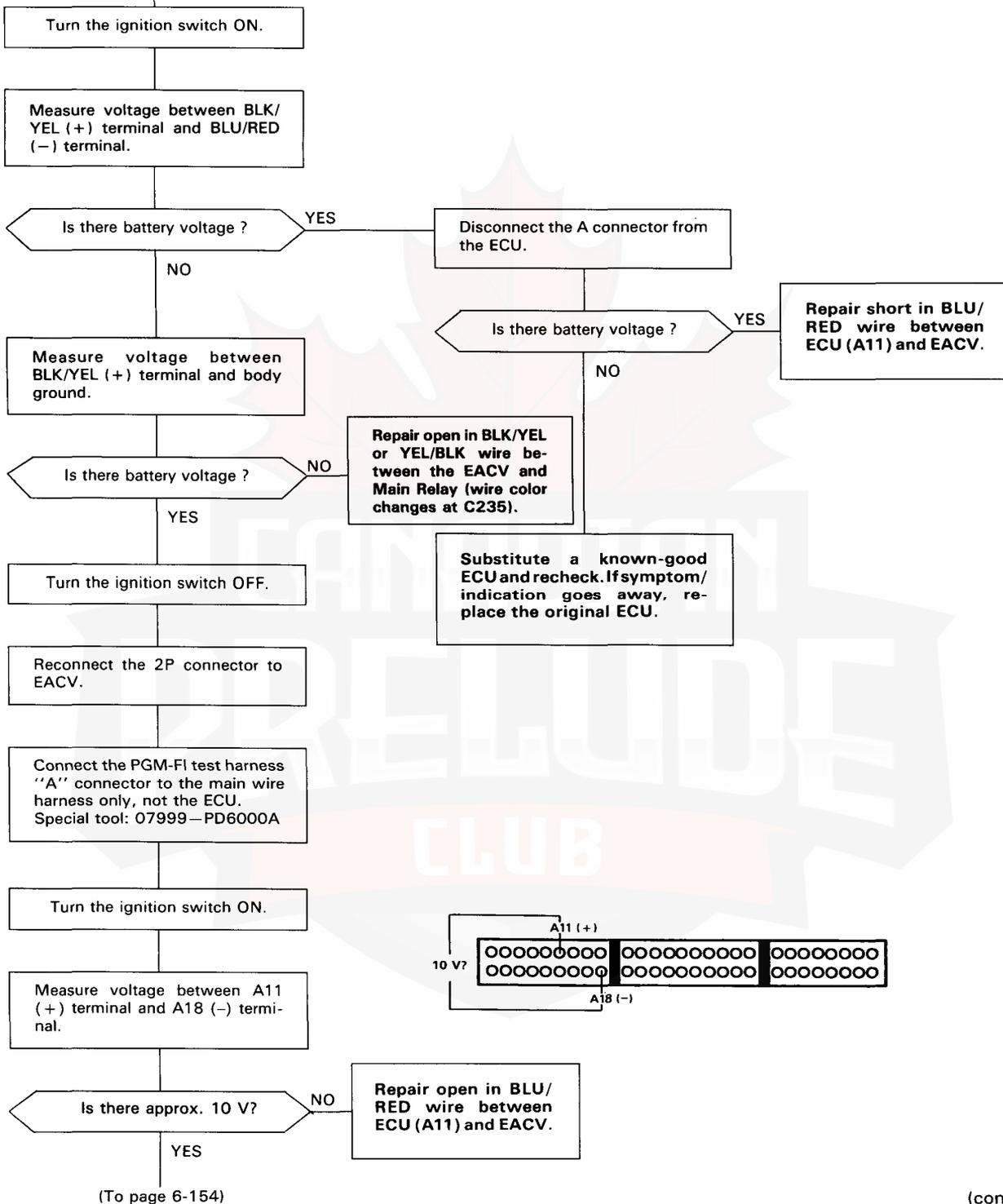

(cont'd)

Idle Control System

Troubleshooting Flowchart — EACV [KF, KE, KB, KW, KT, KQ, KY] (cont'd)

(From page 6-153)

Connect and disconnect A11 terminal to A18 terminal.

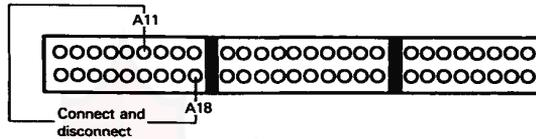

Does EACV click when the connector is connected and disconnected?

NO

Replace EACV.

YES

Substitute a known-good ECU and recheck. If symptom/indication goes away, replace the original ECU.

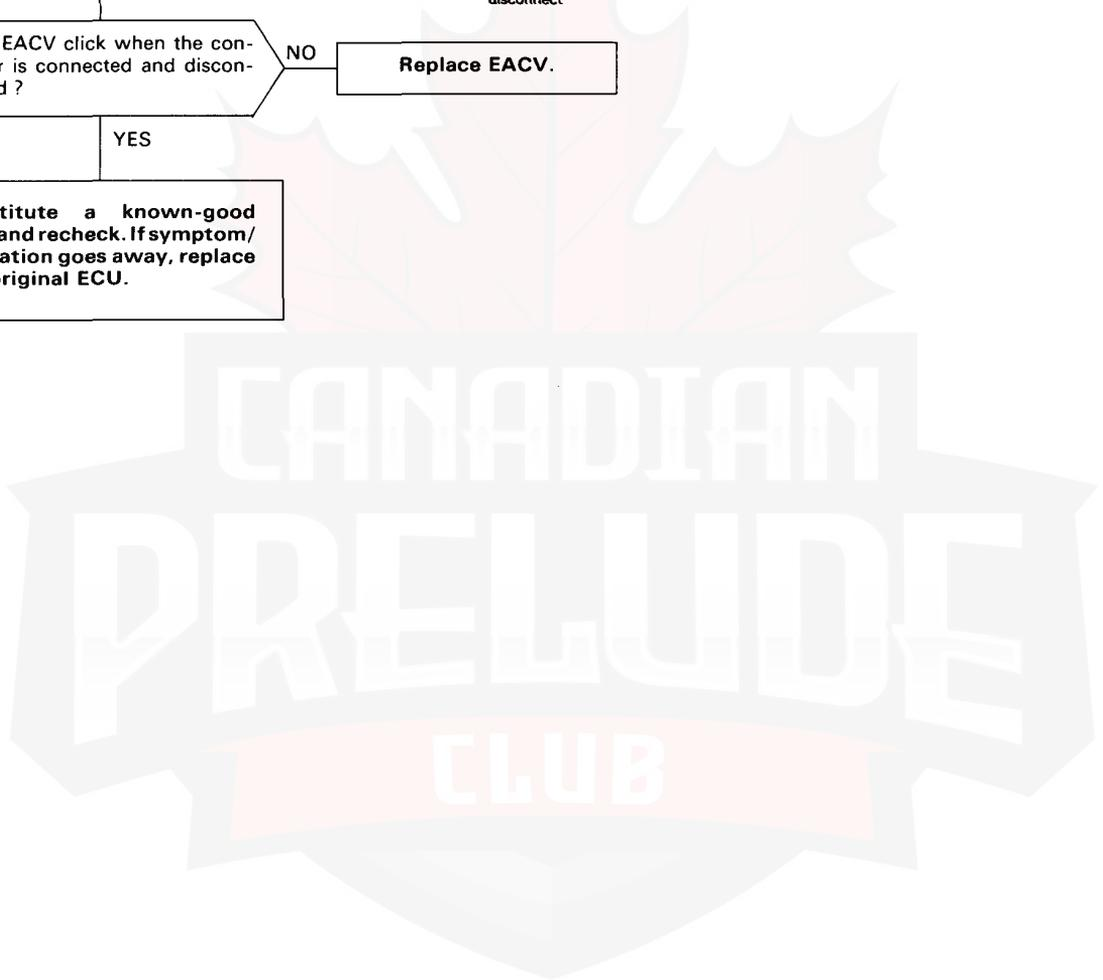



Troubleshooting Flowchart — EACV [KZ, KS, KX]

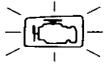

Self-diagnosis LED indicates code 14: A problem in the Electronic Air Control Valve (EACV) circuit.

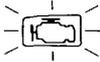

- Engine is running.
- Check Engine warning light has been reported on.
- LED indicates CODE 14.

Turn the ignition switch OFF.

Remove CLOCK fuse in the under-hood relay box for 10 seconds to reset ECU.

Start the engine.

Is Check Engine warning light on and does LED indicate CODE 14?

NO

Intermittent failure, system is OK at this time (test driving may be necessary). Check for poor connections or loose wires at EACV and at C235.

YES

Stop the engine.

Disconnect the 2P connector from the EACV.

Measure resistance between the 2 terminals on the EACV.

Is there 8—15 Ω ?

NO

Replace EACV.

YES

Check for continuity to body ground on each terminal on the EACV.

Does continuity exist ?

YES

Replace EACV.

NO

(To page 6-156)

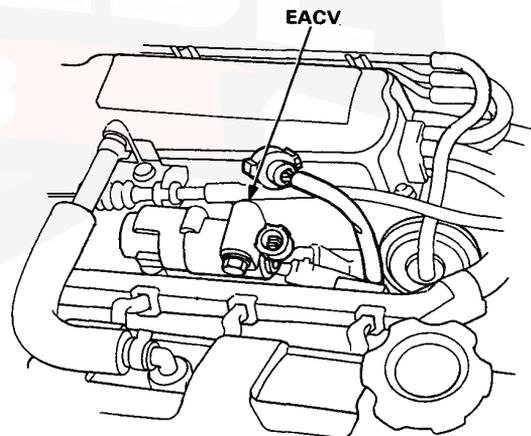

(cont'd)

Idle Control System

Troubleshooting Flowchart — EACV [KZ, KS, KX] (cont'd)

(From page 6-155)

Turn the ignition switch ON.

Measure voltage between BLK/YEL (+) terminal and BLU/RED (-) terminal.

Is there battery voltage ?

YES

Disconnect the "A" connector from the ECU.

Measure voltage between BLK/YEL (+) terminal and BLU/RED (-) terminal.

Is there battery voltage ?

YES

Repair short in BLU/RED wire between ECU (A9) and EACV.

NO

Measure voltage between BLK/YEL (+) terminal and body ground.

Is there battery voltage ?

NO

Repair open in BLK/YEL or YEL/BLK wire between the EACV and Main Relay (wire color changes at C235).

YES

Turn the ignition switch OFF.

Reconnect the 2P connector to EACV.

Connect the ECU test harness (page 6-116) "A" connector to the main wire harness only, not the ECU.

Turn the ignition switch ON.

Measure voltage between A9 (+) terminal and A23 (-) terminal.

Is there approx. 10 V?

NO

Repair open in BLU/RED wire between ECU (A9) and EACV.

YES

(To page 6-157)

Substitute a known-good ECU and recheck. If symptom/indication goes away, replace the original ECU.

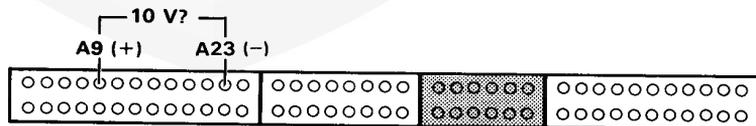



(From page 6-156)

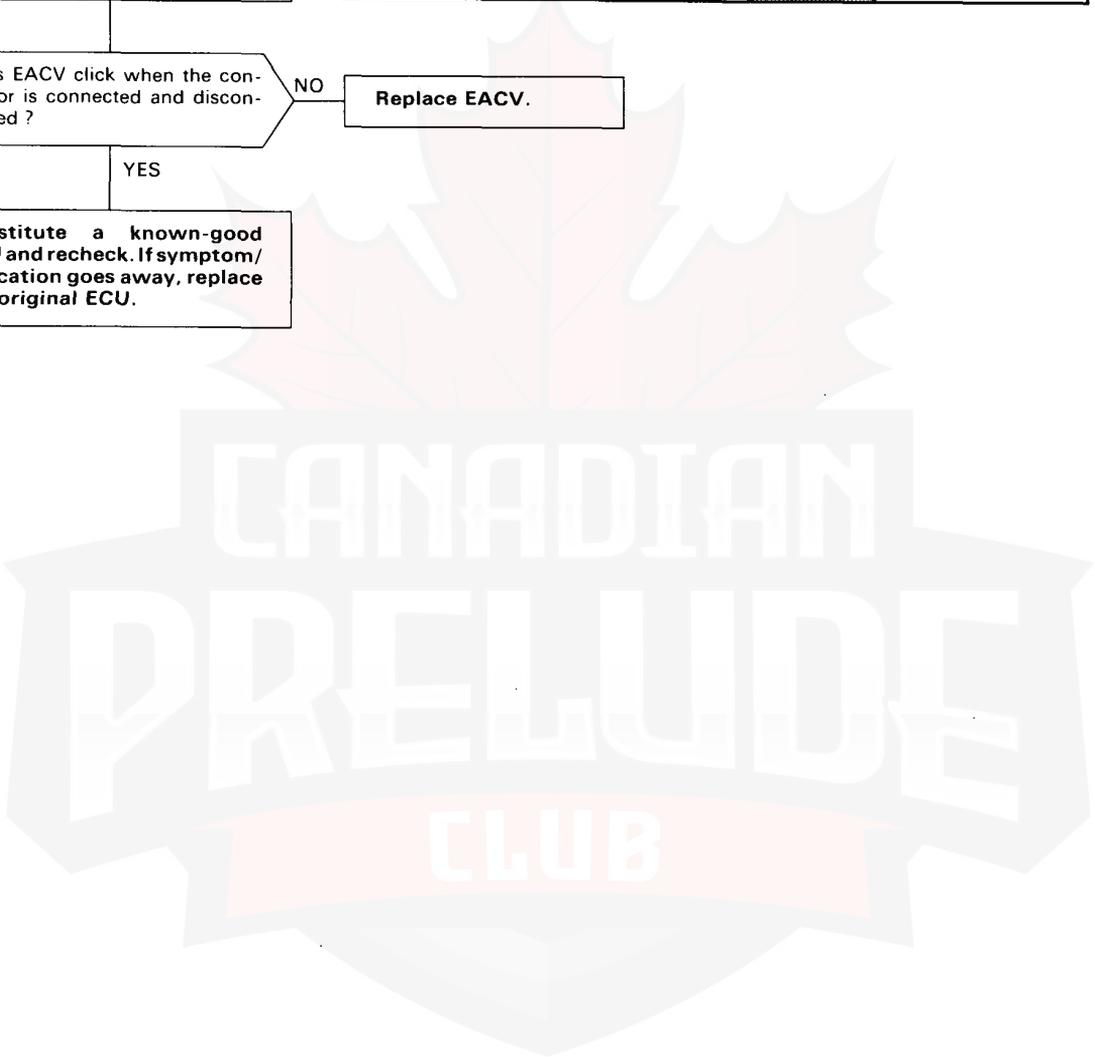
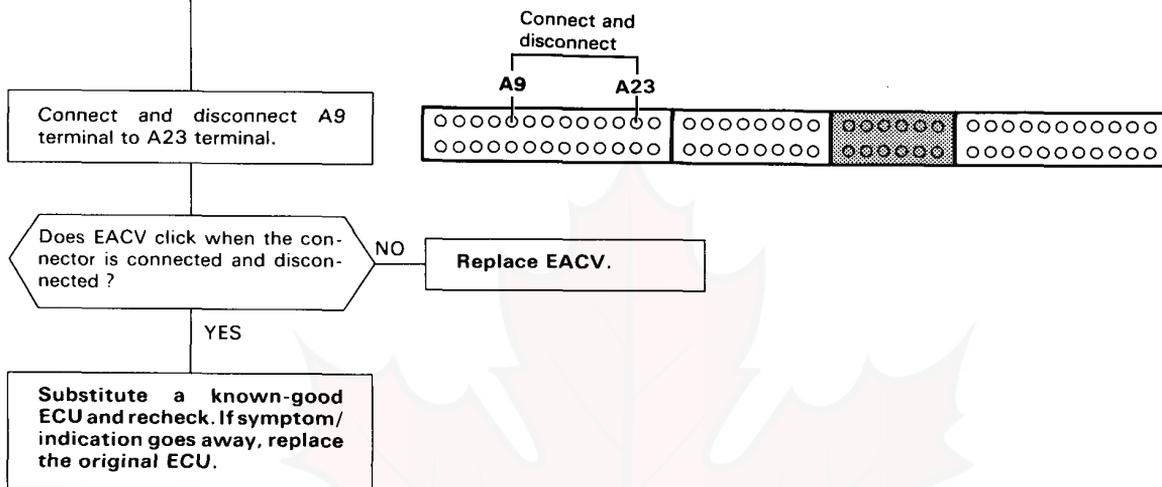

Idle Control System

Troubleshooting Flowchart — Air Conditioning Signal

Inspection of Air Conditioning Signal.

Connect the ECU test harness between the ECU and connector (page 6-116). Disconnect "B" connector from the main wire harness only, not the ECU.

Turn the ignition switch ON.

Measure voltage between B5 (+) terminal and A26 (-) terminal.

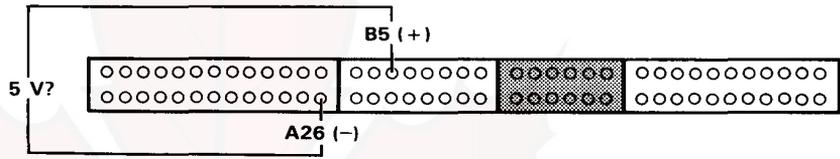

Is there approx. 5 V?

NO

Substitute a known-good ECU and recheck. If prescribed voltage is now available, replace the original ECU.

YES

Turn the ignition switch OFF.

Reconnect "B" connector to the main wire harness.

Turn the ignition switch ON.

Momentarily connect A15 terminal to A26 terminal several times.

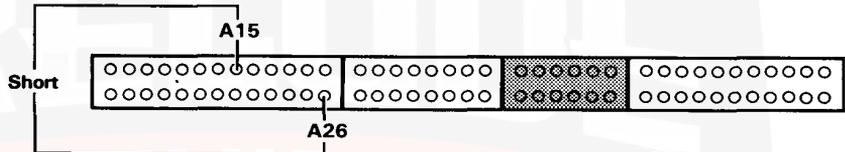

Is there a clicking noise from the A/C compressor clutch?

NO

Connect the RED/BLU terminal of the 13P connector on the compressor control unit to body ground.

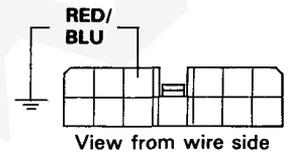

YES

Start the engine.

Blower switch ON.

(To page 6-159)

Is there a clicking noise from the A/C compressor clutch?

NO

See Air conditioner inspection (section 15).

YES

Repair open in RED/BLU wire between ECU (A15) and compressor control unit.

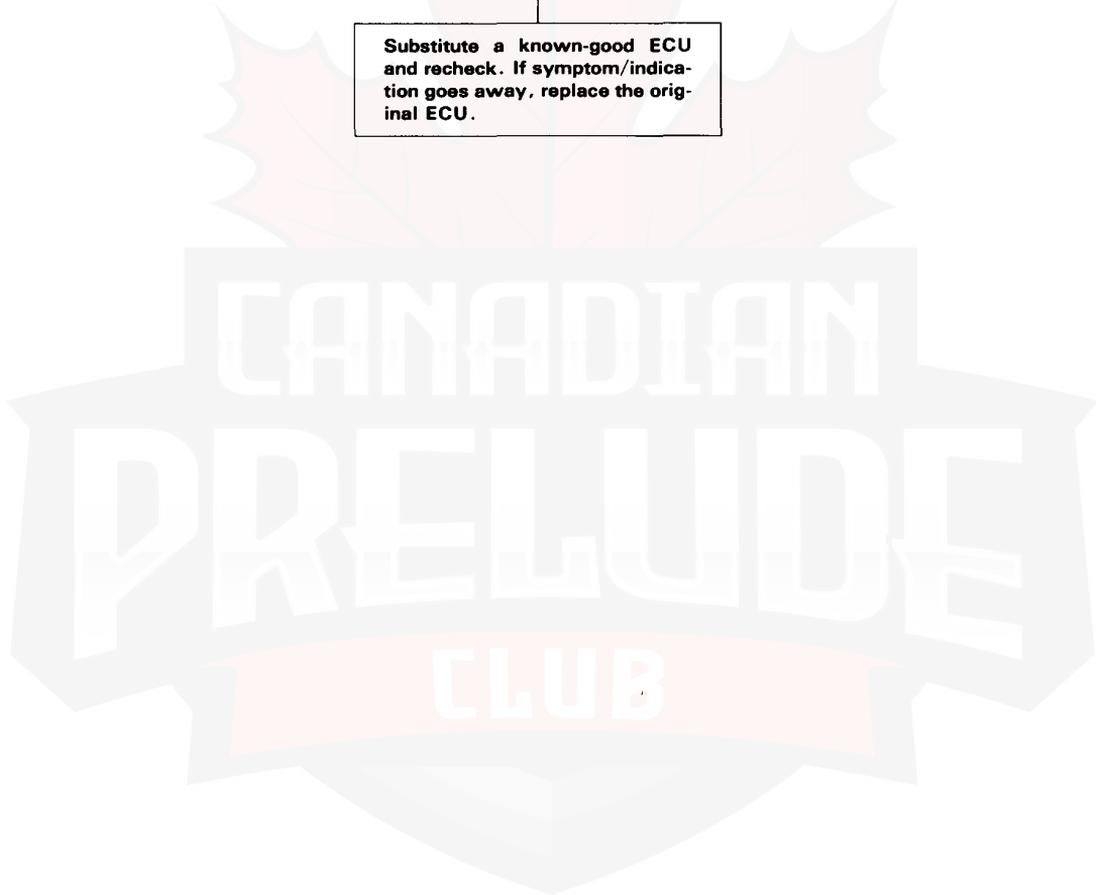
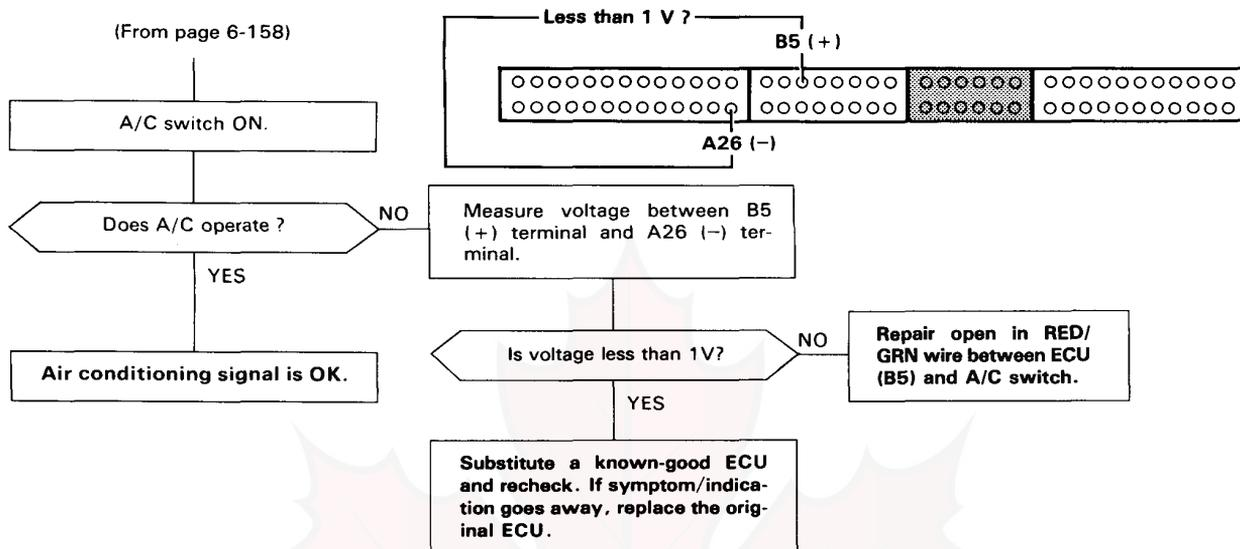

Idle Control System

Troubleshooting Flowchart — Alternator FR Signal

Inspection of Alternator FR signal.

Connect the ECU test harness between the ECU and connector (page 6-116). Disconnect "D" connector from the main wire harness only, not the ECU.

Turn the ignition switch ON.

Measure voltage between D9 (+) terminal and A26 (-) terminal.

Is there approx. 5 V?

NO

YES

Turn the ignition switch OFF.

Reconnect "D" connector to the main wire harness.

Warm up engine to normal operating temperature (cooling fan comes on).

Measure voltage between D9 (+) terminal and A26 (-) terminal.

Does the voltage decrease when headlights and rear defogger are turned on?

NO

YES

Alternator FR signal is OK.

(To page 6-161)

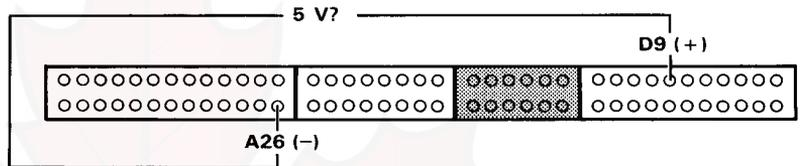

Substitute a known-good ECU and recheck. If prescribed voltage is now available, replace the original ECU.

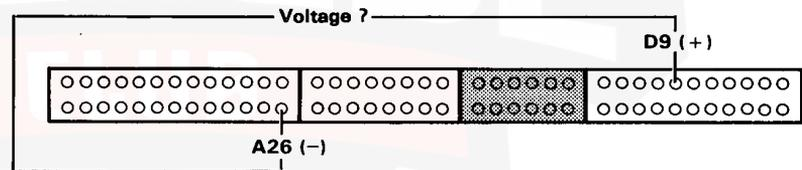

Stop the engine.



(From page 6-160)

Disconnect "D" connector from ECU only, not the main wire harness.

Disconnect the negative battery cable from the battery.

Check for continuity between D9 terminal and body ground.

Does continuity exist ?

YES

Disconnect GRN connector from the alternator.

NO

Disconnect GRN connector from the alternator.

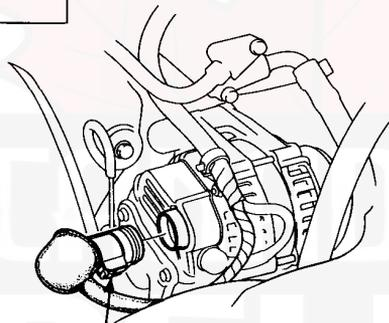

GRN CONNECTOR

Connect WHT/RED wire to body ground.

Check for continuity between D9 terminal and body ground.

Does continuity exist ?

YES

Check for continuity between D9 terminal and body ground.

Does continuity exist ?

NO

See Alternator Inspection (section 16).

YES

Repair short in WHT/RED wire between ECU (D9) and alternator.

NO

Repair open in WHT/RED wire between ECU (D9) and alternator.

See Alternator Inspection (section 23).

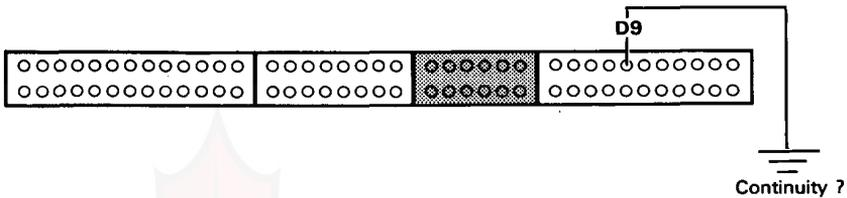

Continuity ?

Idle Control System

Troubleshooting Flowchart — A/T Shift Position Signal

Inspection of A/T Shift Position Signal.

Turn the ignition switch ON.

Observe the A/T shift indicator and select each position separately.

Does the indicator light properly?

NO

See A/T shift position Indicator Inspection (section 16).

YES

Turn the ignition switch OFF.

Connect the ECU test harness between the ECU and connector (page 6-116). Disconnect "B" connector from the main wire harness only, not the ECU.

Turn the ignition switch ON.

Measure voltage between B7 (+) terminal and A26 (-) terminal.

Is there approx. 5 V?

NO

Substitute a known-good ECU and recheck. If prescribed voltage is now available, replace the original ECU.

YES

Turn the ignition switch OFF.

Reconnect "B" connector to the main wire harness.

Turn the ignition switch ON.

(To page 6-163)

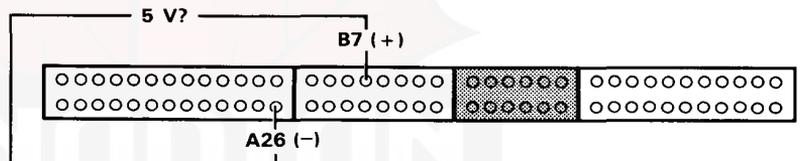



(From page 6-162)

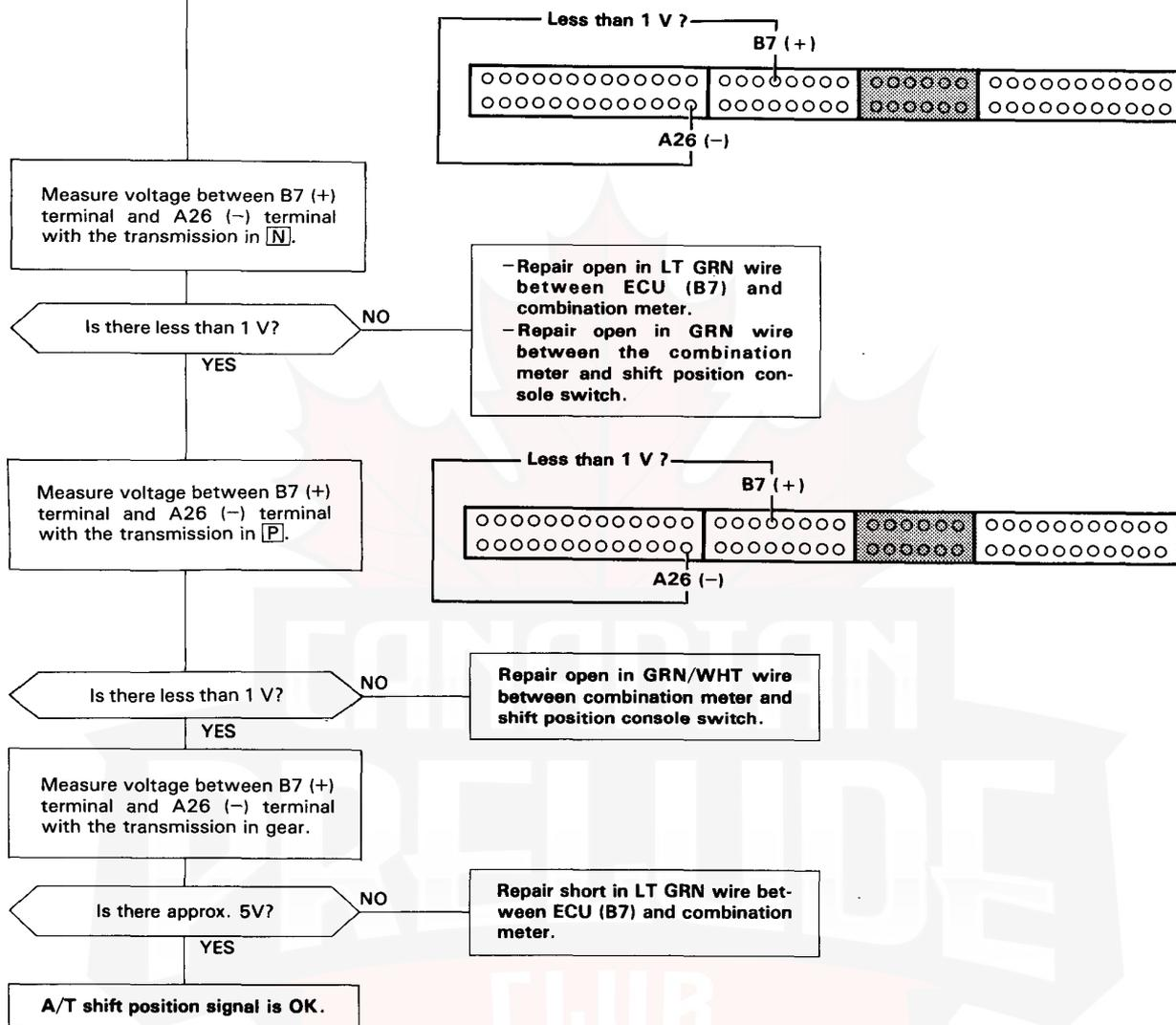

Idle Control System

Troubleshooting Flowchart — Starter Switch Signal

Inspection of Starter Switch Signal.

Connect the ECU test harness between the ECU and connector (page 6-116).

Measure voltage between B9 (+) terminal and A26 (-) terminal with the ignition switch turned to the start position.

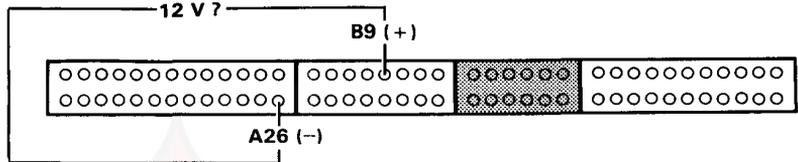

NOTE: Clutch pedal must be depressed on M/T models.

Is there battery voltage ?

NO

YES

Inspect No. 1 (A/T) or No. 3 (M/T) fuse.

Is No. 1 (A/T) or No. 3 (M/T) fuse OK?

NO

Replace fuse.

YES

Repair open in BLU/RED, BLK/GRN (M/T) wire between ECU (B9) and No. 1 (A/T) or No. 3 (M/T) fuse.

Starter switch signal is OK.



Troubleshooting Flowchart — P/S Oil Pressure Signal

Inspection of P/S Oil Pressure Signal

Connect the ECU test harness between the ECU and connector (page 6-116).

Turn the ignition switch ON.

Measure voltage between B8 (+) terminal and A26 (-) terminal.

Is there voltage ?

YES

Disconnect the 2P connector on the P/S oil pressure switch.

Connect BLU/RED terminal to BLK terminal.

Is there voltage ?

NO

Replace P/S oil pressure switch.

YES

Repair open in BLU/RED wire between ECU (B8) and P/S oil pressure switch or BLK wire between P/S oil pressure switch and G301.

Turn the ignition switch OFF.

Disconnect "B" connector from main wire harness only, not the ECU.

Turn the ignition switch ON.

Is there battery voltage ?

NO

Substitute a known-good ECU and recheck. If prescribed voltage is now available, replace the original ECU.

YES

Reconnect "B" connector to main wire harness and disconnect 2P connector on the P/S oil pressure switch.

Is there battery voltage ?

YES

Replace P/S oil pressure switch.

NO

Repair short in BLU/RED wire between ECU (B8) and the P/S oil pressure switch.

Is there battery voltage ?

NO

Turn the ignition switch OFF.

Disconnect "B" connector from main wire harness only, not the ECU.

Turn the ignition switch ON.

Is there battery voltage ?

NO

Substitute a known-good ECU and recheck. If prescribed voltage is now available, replace the original ECU.

YES

Reconnect "B" connector to main wire harness and disconnect 2P connector on the P/S oil pressure switch.

Is there battery voltage ?

YES

Replace P/S oil pressure switch.

NO

Repair short in BLU/RED wire between ECU (B8) and the P/S oil pressure switch.

P/S oil pressure signal is OK.

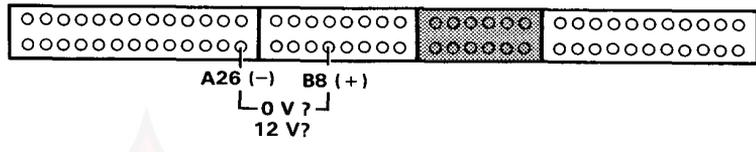

Idle Control System

Idle Speed Setting

Inspection/Adjustment

1. Start the engine and warm it up to normal operating temperature (the cooling fan comes on).
2. Connect a tachometer.

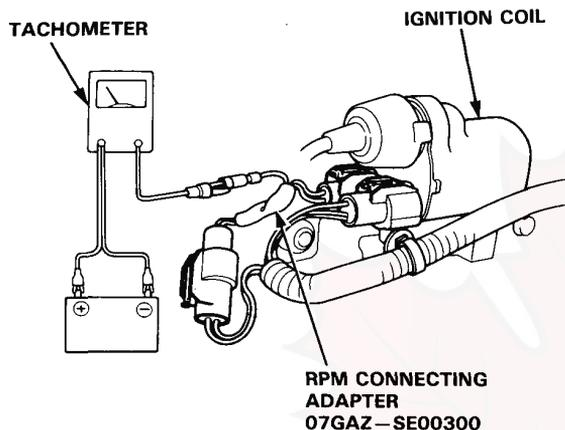

3. Disconnect the 2P connector from the EACV.

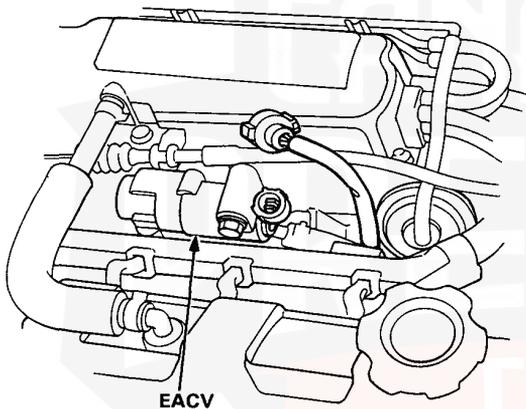

4. Check idling in no-load conditions in which the headlights, blower fan, rear defogger, cooling fan, and air conditioner are not operating.

Idle speed should be:

- KX, KS, KZ, KQ
M/T $650 \pm 50 \text{ min}^{-1}$ (rpm)
A/T $650 \pm 50 \text{ min}^{-1}$ (rpm) in **N** or **P**
- Other models
M/T $700 \pm 50 \text{ min}^{-1}$ (rpm)
A/T $700 \pm 50 \text{ min}^{-1}$ (rpm)

Adjust the idle speed, if necessary, by turning the idle adjusting screw.

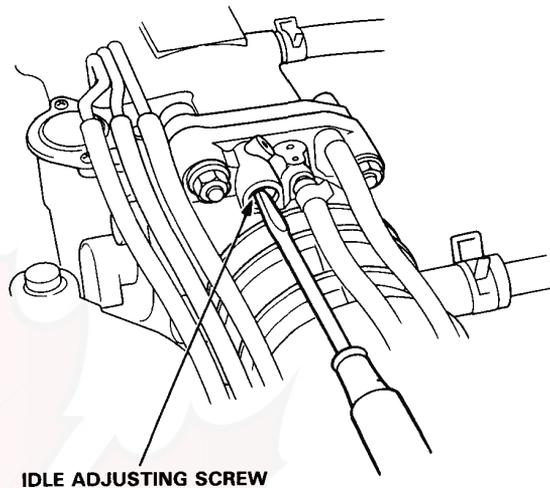

5. Turn the ignition switch OFF.
6. Reconnect the 2P connector on the EACV, then remove CLOCK fuse in the under-hood relay box for 10 seconds to reset ECU.
7. Restart and idle the engine with no-load conditions in which the headlights, blower fan, rear defogger, cooling fan, and air conditioner are not operating for one minute, then check the idle speed.

Idle speed should be:

- KX, KS, KZ, KQ
M/T $750 \pm 50 \text{ min}^{-1}$ (rpm)
A/T $750 \pm 50 \text{ min}^{-1}$ (rpm) in **N** or **P**
- Other models
M/T $800 \pm 50 \text{ min}^{-1}$ (rpm)
A/T $800 \pm 50 \text{ min}^{-1}$ (rpm)

8. Idle the engine for one minute with heater fan switch at HI and air conditioner on, then check the idle speed.

Idle should remain stable at:

- KX, KS, KZ, KQ
 $750 \pm 50 \text{ min}^{-1}$ (rpm)
- Other models
 $800 \pm 50 \text{ min}^{-1}$ (rpm)

NOTE: If the idle speed is not within specification, see System Troubleshooting Guide on page 6-150.

Fuel Supply System

System Troubleshooting Guide



NOTE: Across each row in the chart, the systems that could be sources of a symptom are ranked in the order they should be inspected starting with ①. Find the symptom in the left column, read across to the most likely source, then refer to the page listed at the top of that column. If inspection shows the system is OK, try the next most likely system ②, etc.

SUB SYSTEM		FUEL INJECTOR	INJECTOR RESISTOR	PRESSURE REGULATOR	FUEL FILTER	FUEL PUMP	MAIN RELAY	CONTAMINATED FUEL
PAGE		168	—	—	—	—	—	*
SYMPTOM								
ENGINE WON'T START		③	③		③	①	②	③
DIFFICULT TO START ENGINE WHEN COLD OR HOT				③	②			①
ROUGH IDLE		①	②					③
POOR PERFORMANCE	MISFIRE OR ROUGH RUNNING	①	②	③				③
	FAILS EMISSION TEST	②	③	①				
	LOSS OF POWER	③	③		①	③		②

* Fuel with dirt, water or a high percentage of alcohol is considered contaminated.



Fuel Supply System

Fuel Injectors

Troubleshooting Flowchart

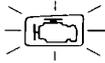

Self-diagnosis LED indicates code 16: A problem in the fuel injector circuit.

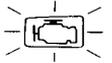

- Check Engine warning light has been reported on.
- LED indicates CODE 16.

Turn the ignition switch OFF.

Remove CLOCK fuse in the under-hood relay box for 10 seconds to reset ECU.

Turn the ignition switch to START position.

Does the engine start ?

NO

YES

Is Check Engine warning light on and does LED indicate CODE 16?

NO

YES

Intermittent failure, system is OK at this time (test drive may be necessary).
Check for poor connections or loose wires at injectors, injector resistor and C235 (located at right shock tower).

Check the clicking sound of each injector by means of a stethoscope when the engine is idling.

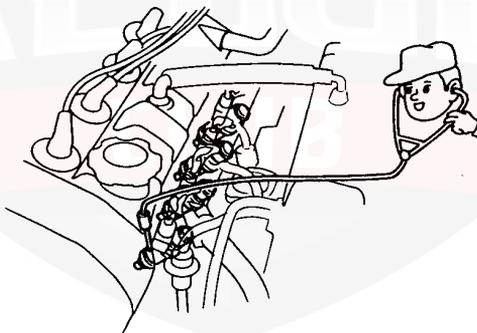

Do the injectors click ?

YES

NO

Substitute a known-good ECU and re-check. If symptom/indication goes away, replace the original ECU.

(To page 6-169)

(To page 6-169)



(From page 6-168)

Turn the ignition switch OFF.

Disconnect the 2P connector from the injector that does not click.

Measure resistance between the 2 terminals of the injector.

Is there 1.5—2.5Ω ?

YES

Turn the ignition switch ON.

Measure voltage between RED/BLK (+) terminal on the 2P connector and body ground.

Is there battery voltage ?

YES

(To page 6-170)

(From page 6-168)

Turn the ignition switch OFF.

Disconnect the 2P connector from each injector.

Measure resistance between the 2 terminals of the injector.

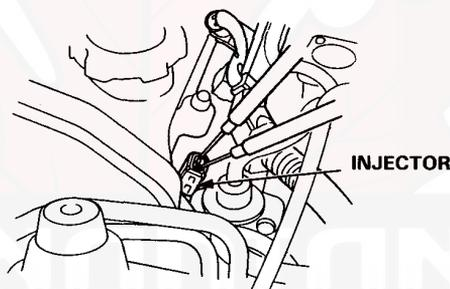

NO
Replace the injector.

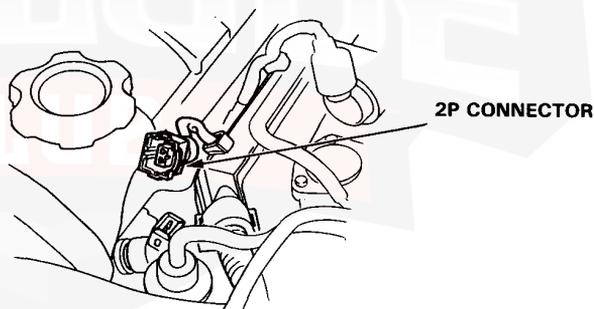

NO
Turn the ignition switch OFF.

(To page 6-170)

Fuel Supply System

Fuel Injectors (cont'd)

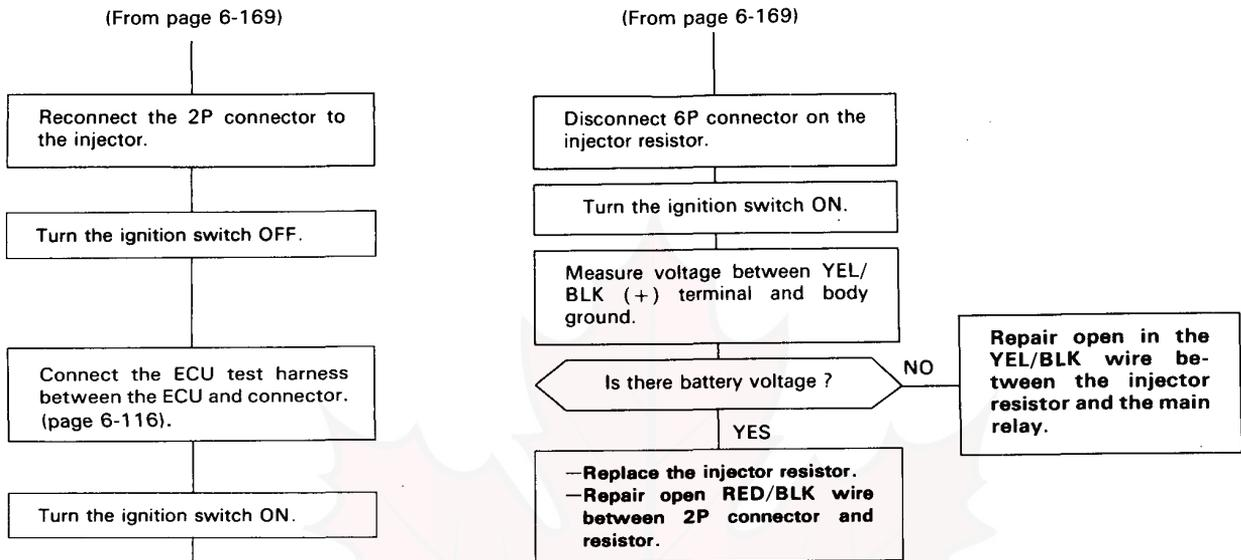

(To page 6-171)



(From page 6-170)

Measure voltage between A23(-) terminal and following terminals.

- No. 1 injector: A1 (+) terminal.
- No. 2 injector: A3 (+) terminal.
- No. 3 injector: A5 (+) terminal.
- No. 4 injector: A2 (+) terminal.

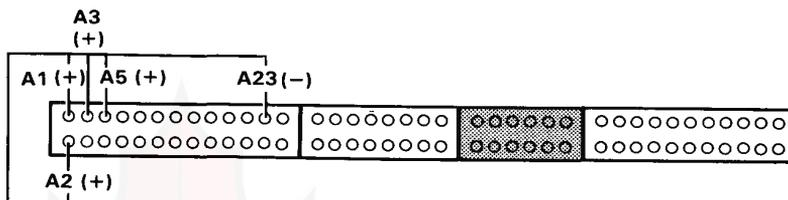

Is there battery voltage ?

NO

Repair open in the wire between the ECU (A1, A3, A5 or A2) and the injector.

YES

Substitute a known-good ECU and recheck. If symptom/indication goes away, replace the original ECU.



Air Intake System

System Troubleshooting Guide

NOTE: Across each row in the chart, the sub systems that could be sources of a symptom are ranked in the order they should be inspected starting with ①. Find the symptom in the left column, read across to the most likely source, then refer to the page listed at the top of that column. If inspection shows the system is OK, try the next system ②, etc.

SUB SYSTEM	THROTTLE CABLE	THROTTLE BODY	BYPASS CONTROL SYSTEM
PAGE			174
SYMPTOM	—	—	
WHEN WARM RPM TOO HIGH	②	①	
LOSS OF POWER		①	②





Air Cleaner

Air Cleaner Element Replacement

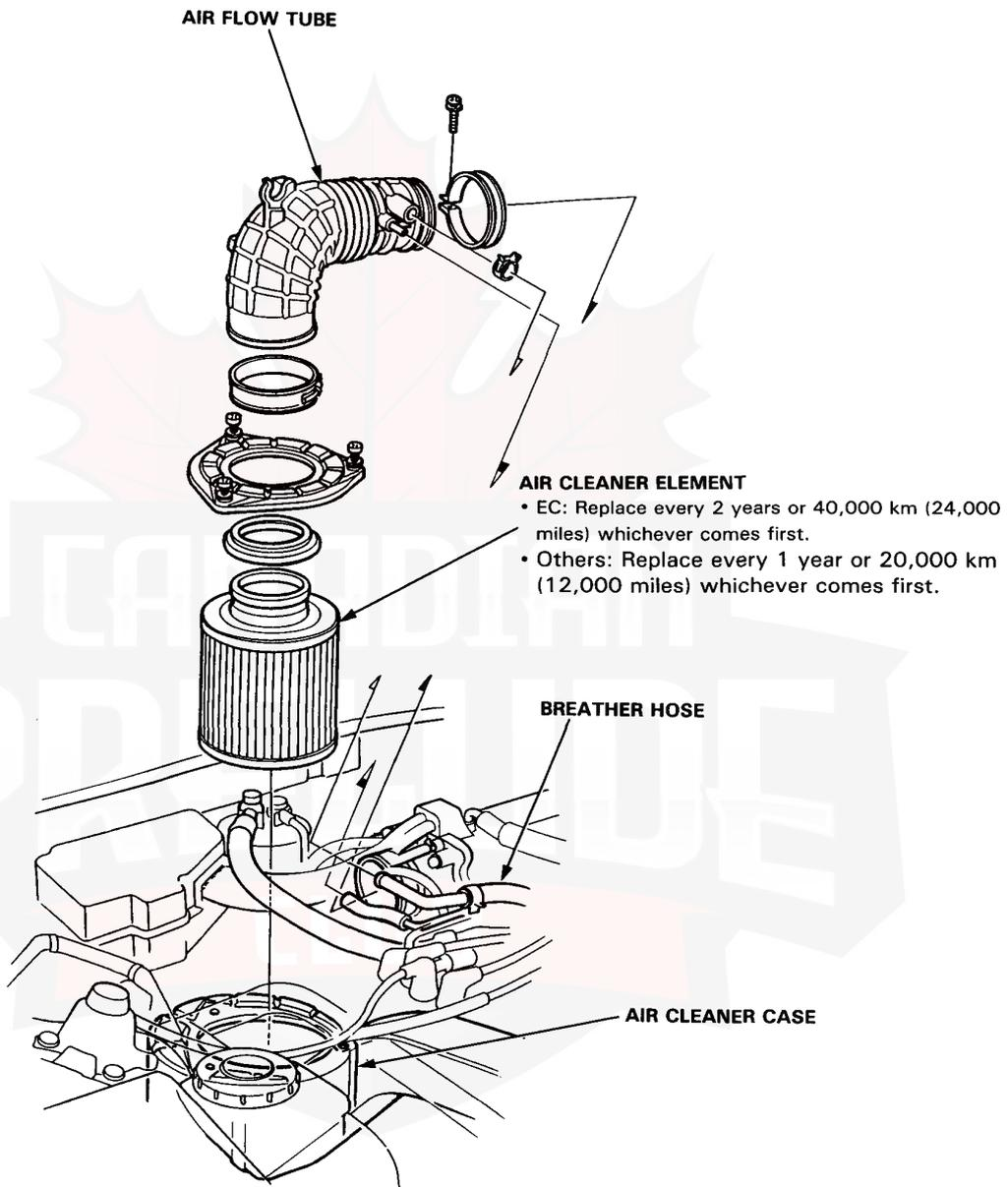

Air Intake System

Bypass Control System

Troubleshooting Flow Chart

Inspection of Bypass Control System

Start engine and allow to idle.

Remove #13 vacuum hose from the bypass control diaphragm and connect vacuum gauge to the hose.

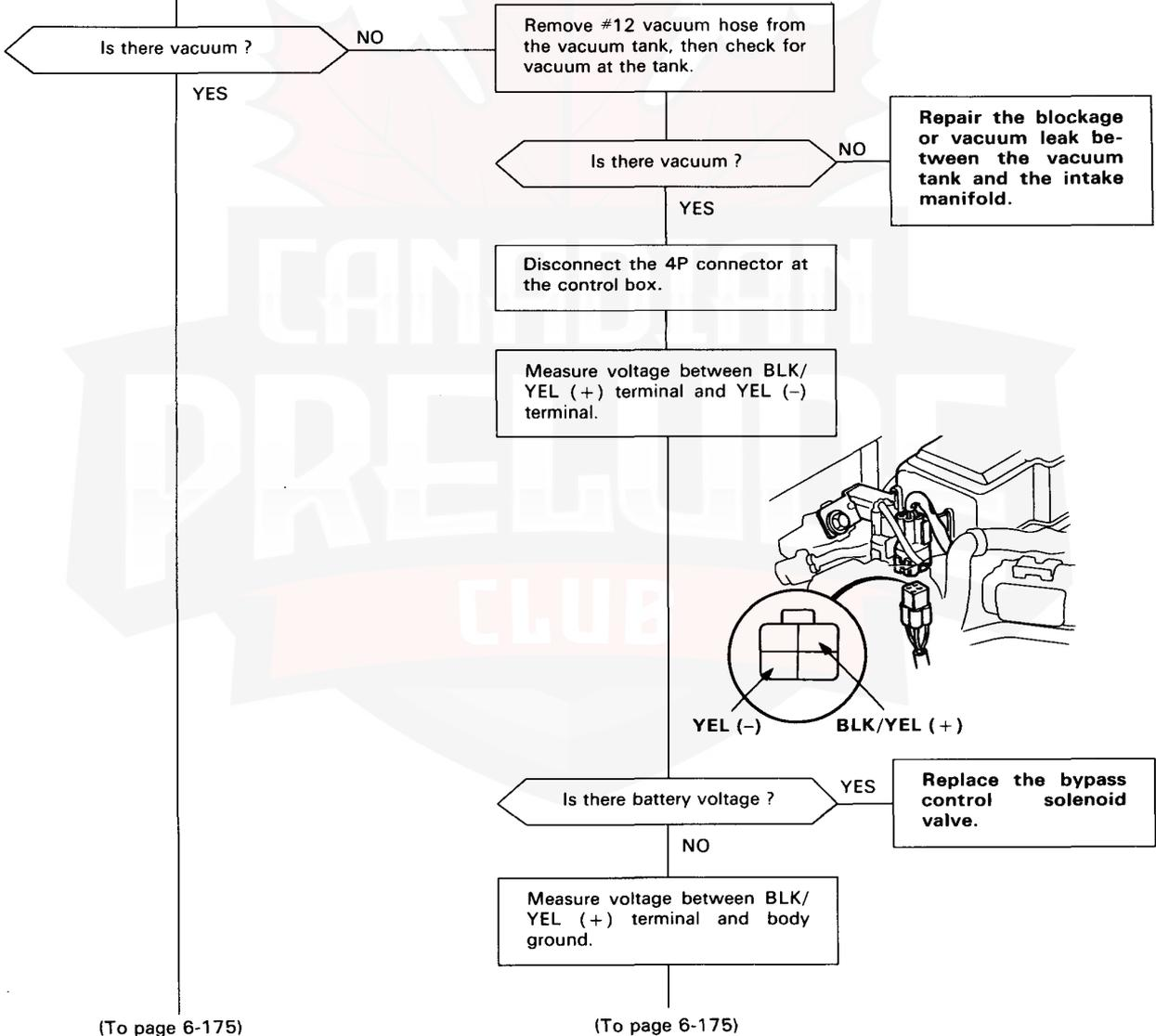
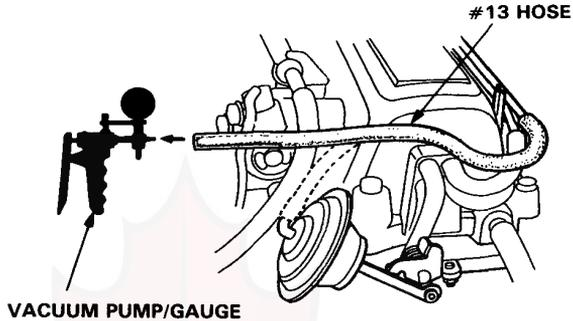

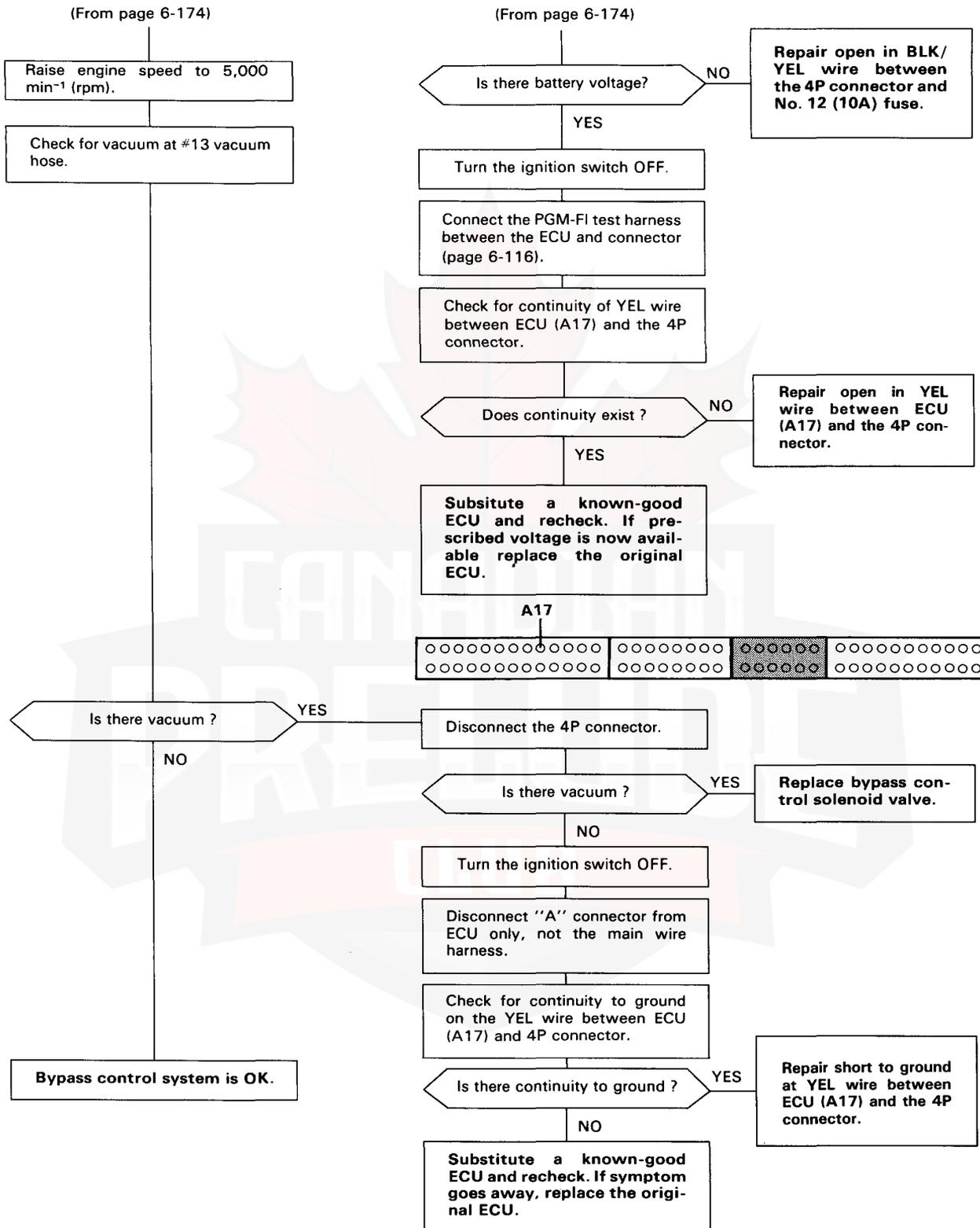

Air Intake System

Bypass Valve System

Testing

CAUTION: Do not adjust the bypass valve full-close screw. It was preset at the factory.

1. Check the bypass valve shaft for binding or sticking.
2. Check the bypass valve for smooth movement.
3. Check that **(A)** of the bypass valve is in close contact with the stopper when the bypass valve is fully open.

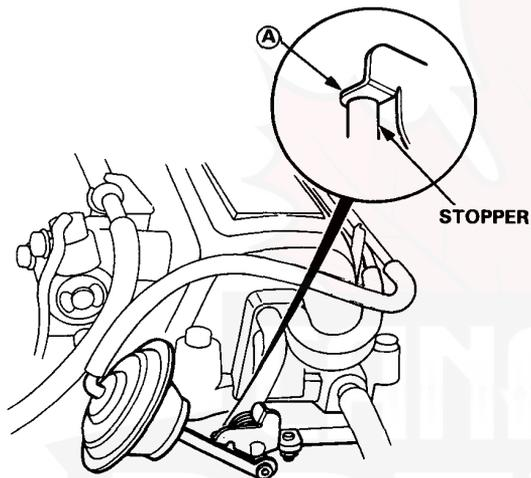

4. Check that **(B)** of the bypass valve is in close contact with the full-close screw when the valve is fully closed.

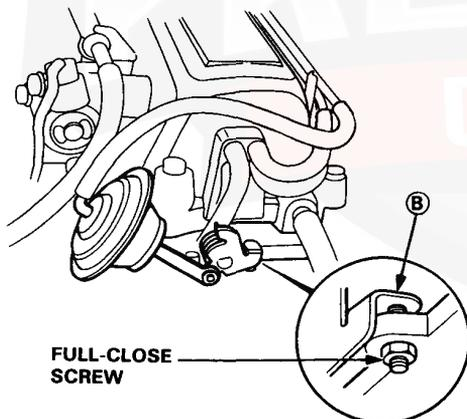

- If any fault is found, clean the linkage and shafts with carburetor cleaner.

— If the problem still exists after cleaning, disassemble the intake manifold and check the bypass valve (page 6-177).



Bypass Control System

Disassembly

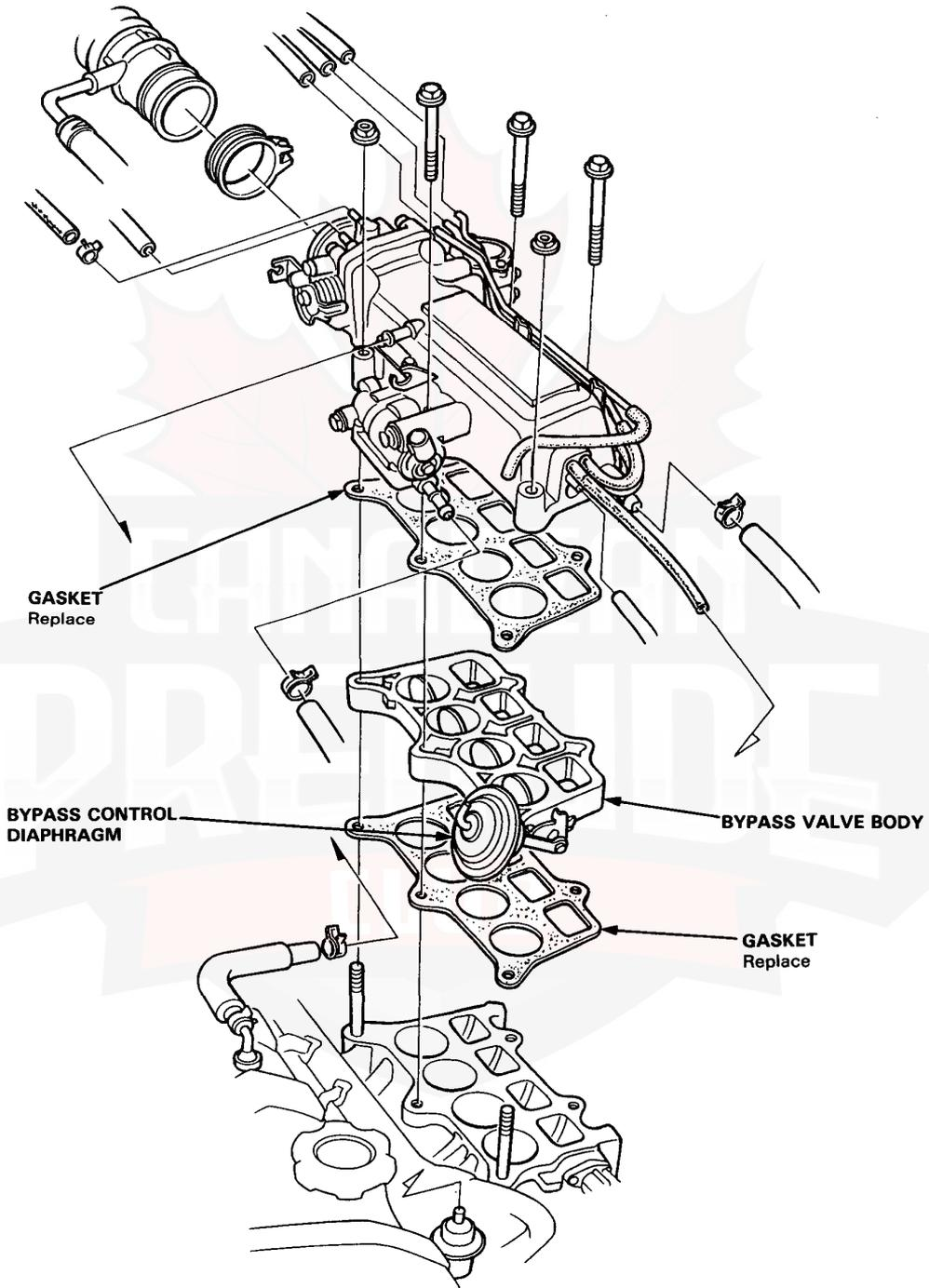

Emission Control System

System Troubleshooting Guide

NOTE: Across each row in the chart, the systems that could be sources of a symptom are ranked in the order they should be inspected starting with ①. Find the symptom in the left column, read across to the most likely source, then refer to the page listed at the top of that column. If inspection shows the system is OK, try the next most likely system ②, etc.

SUB SYSTEM		CATALYTIC CONVERTER	EGR SYSTEM	POSITIVE CRANKCASE VENTILATION SYSTEM	EVAPORATIVE EMISSION CONTROLS
PAGE			179		184
SYMPTOM					
ROUGH IDLE			①	②	
FREQUENT STALLING	AFTER WARMING UP		①		
POOR PERFORMANCE	FAILS EMISSION TEST	①			②
	LOSS OF POWER	①			





Exhaust Gas Recirculation system



- Check Engine warning light has been reported on.
- LED indicates CODE 12.

Turn the ignition switch OFF.

Remove CLOCK fuse in the under-hood relay box for 10 seconds to reset ECU.

Road test necessary: Warm up the engine to normal operating temperature (cooling fan comes on). Drive the car on the road for approx. 10 minutes. Try to keep the engine speed in the 1700— 2500 range.

Is Check Engine warning light on and does LED indicated CODE 12 ?

NO

Intermittent failure, system is OK at this time. Check for poor connections or loose wires at EGR valve C235, C236 (located at right shock tower), control box.

YES

With the engine at idle, disconnect the #16 hose from the EGR valve and connect a vacuum pump/gauge to the hose.

Is there any vacuum ?

YES

Disconnect 4P connector from the control box and check the #16 hose for vacuum again.

NO

Move the vacuum pump/gauge to the EGR valve.

16 HOSE

EGR VALVE

VACUUM PUMP/GAUGE

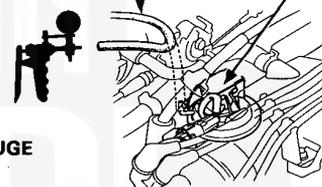

#16 HOSE

EGR VALVE

RED

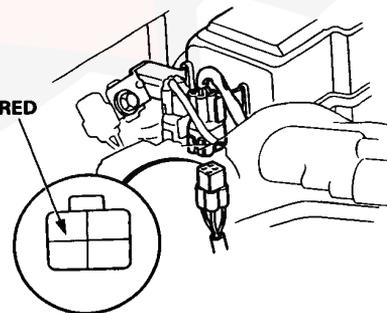
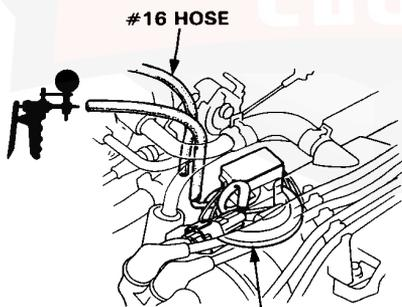

(To page 6-180)

(To page 6-180)

(cont'd)

Emission Control System

Exhaust Gas Recirculation System (cont'd)

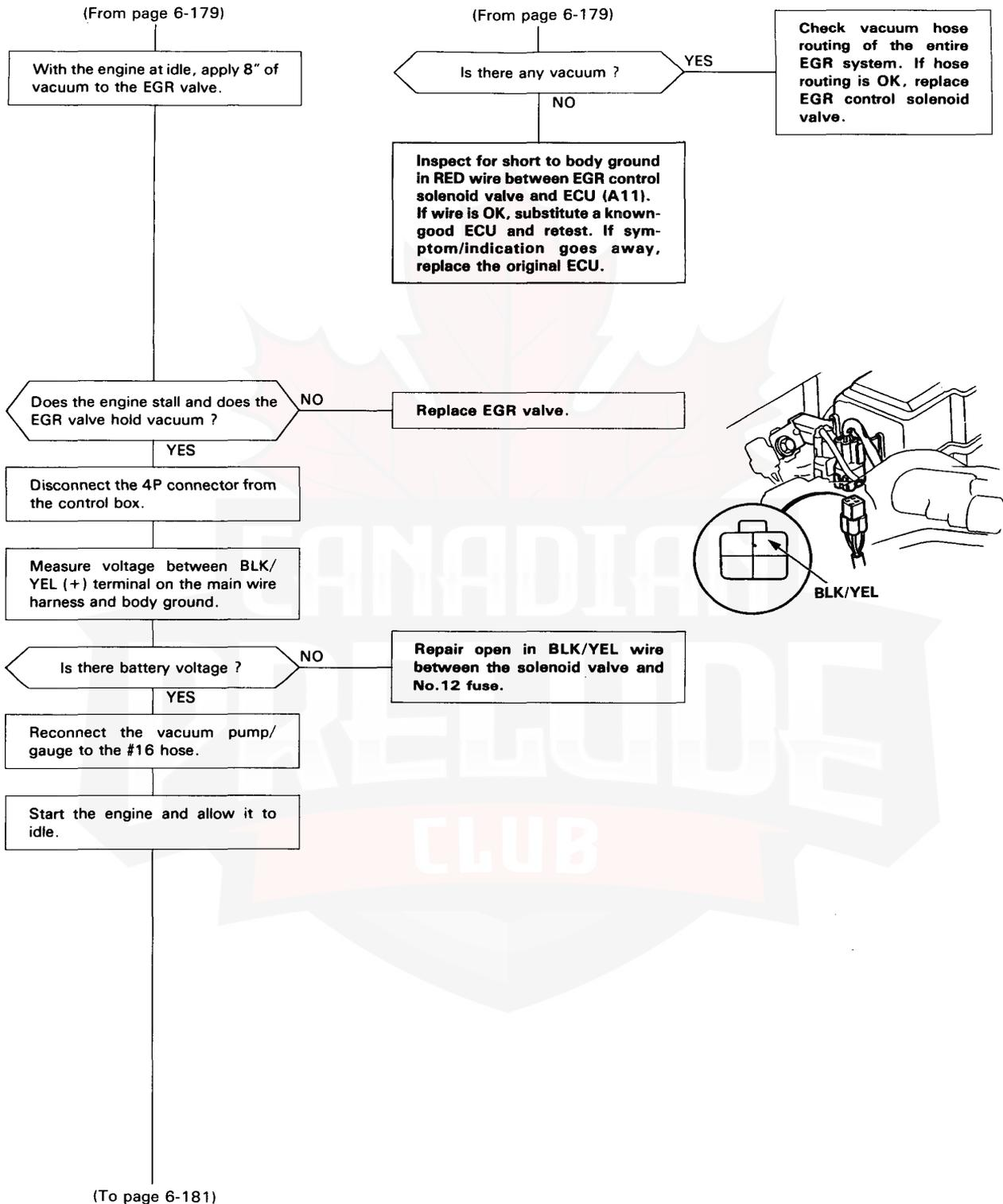



(From page 6-180)

Connect the battery positive terminal to the B terminal of the 4P connector. While watching the vacuum gauge, connect the battery negative terminal to the D terminal.

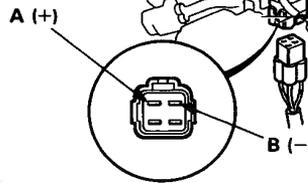

Is there approx. 8" within 1 second?

NO

Turn the ignition switch OFF and inspect the #16 and #24 hoses for leaks, restrictions, or mis-routing.

YES

Turn the ignition switch OFF and reconnect the 4P connector.

Are the hoses OK?

NO

Connect as necessary.

YES



TEST HARNESS
07GMJ-ML80100

VACUUM PUMP/GAUGE

EGR CONTROL SOLENOID VALVE

AIR CHAMBER

Disconnect the lower hose on EGR control solenoid valve and connect a vacuum gauge to the hose.

Start the engine and allow it to idle.

Is there 6"– 10" of vacuum?

NO

Replace CVC valve.

YES

Replace the EGR control solenoid valve.

Connect the test harness between the EGR valve lift sensor and engine wire harness.

Turn the ignition switch ON.

Measure voltage between RED (+) terminal and GRN (-) terminal.

Is there approx. 5 V?

NO

- Repair open in YEL/WHT wire between EGR valve and ECU (D20).
- Repair open in GRN/WHT wire between EGR valve and ECU (D22).

YES

(To page 6-182)

(cont'd)

Emission Control System

Exhaust Gas Recirculation System (cont'd)

(From page 6-181)

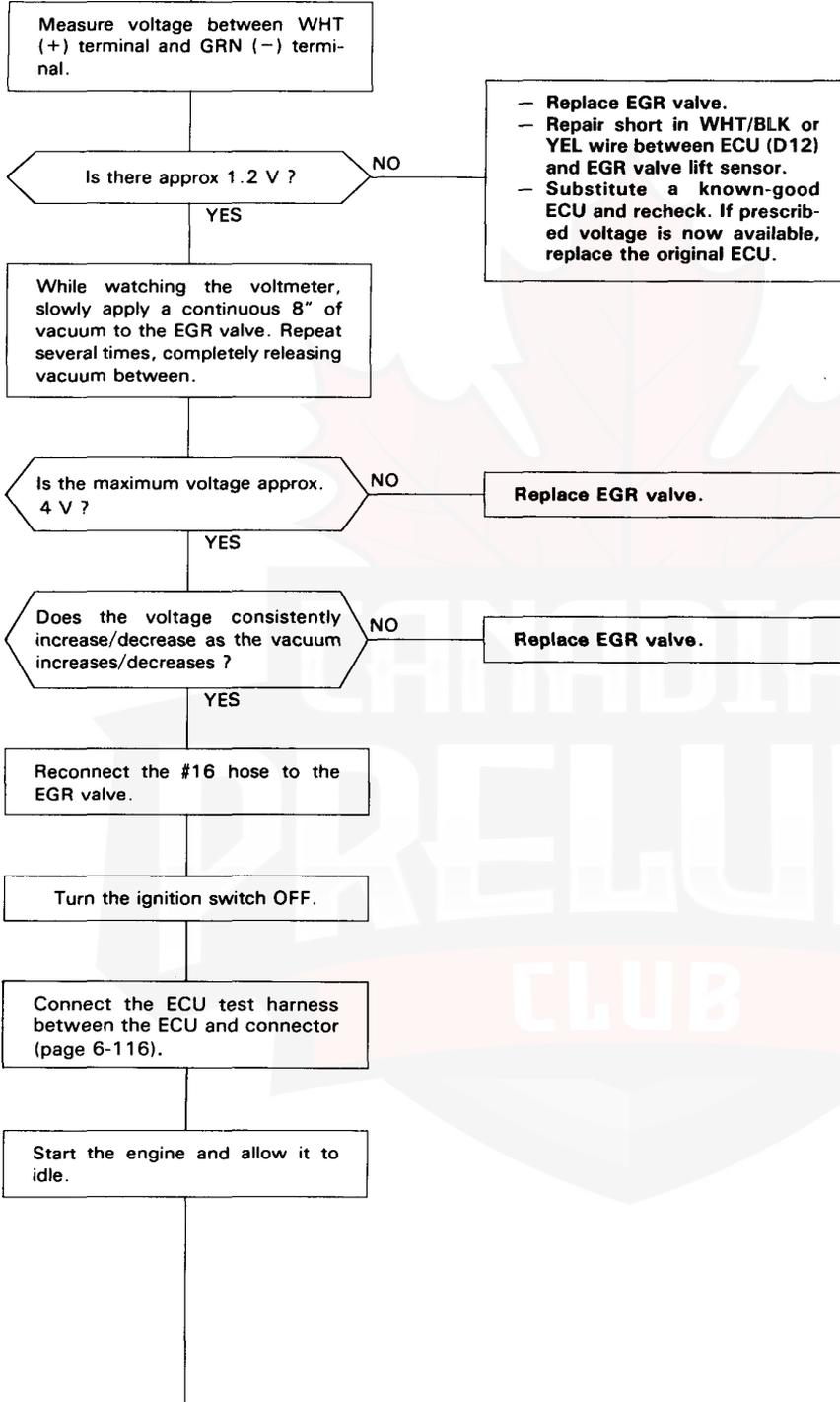



(From page 6-182)

Measure voltage between D12 (+) terminal and D22 (-) terminal.

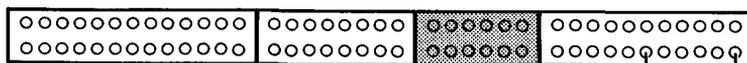

Is there approx. 1.2 V ?

NO

Repair open in WHT/BLK or YEL wire between ECU (D12) and the sensor.

YES

Connect A11 terminal to A26 terminal with a jumper wire.

Did the engine stall ?

NO

Repair open in RED wire between ECU (A11) and EGR control solenoid valve.

YES

Substitute a known-good ECU and recheck. If symptom/indication goes away, replace the original ECU.

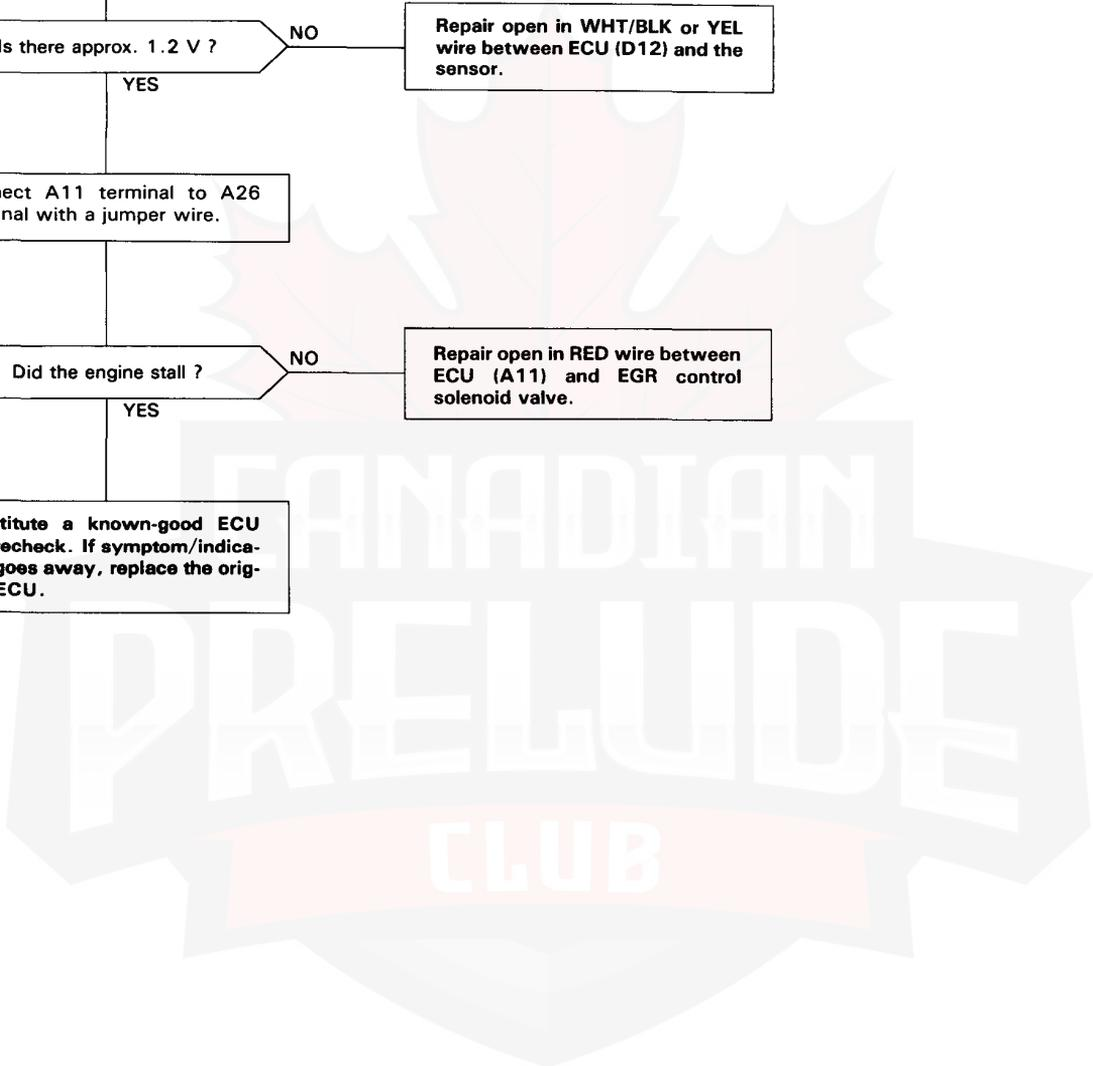

Emission Control System

Evaporative Emission Controls

Troubleshooting Flowchart

Inspection of Evaporative Emission Controls

Disconnect vacuum hose from the purge control diaphragm valve (on the charcoal canister) and connect a vacuum gauge to the hose.

Start the engine and allow to idle.
NOTE: Engine coolant temperature must be below 75°C (167°F).

PURGE CONTROL DIAPHRAGM VALVE

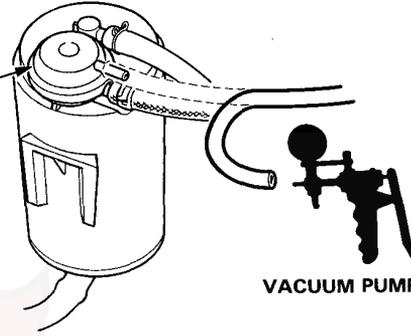

VACUUM PUMP/GAUGE

Is there vacuum ?

YES

Disconnect the 2P connector.

NO

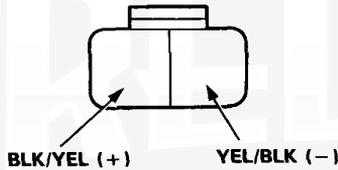

Measure voltage between BLK/YEL (+) terminal and YEL/BLK (-) terminal.

Is there battery voltage ?

YES

Inspect vacuum hose routing.
If OK, replace purge cut-off solenoid valve.

NO

Measure voltage between BLK/YEL (+) terminal and body ground.

(To page 6-185)

(To page 6-185)

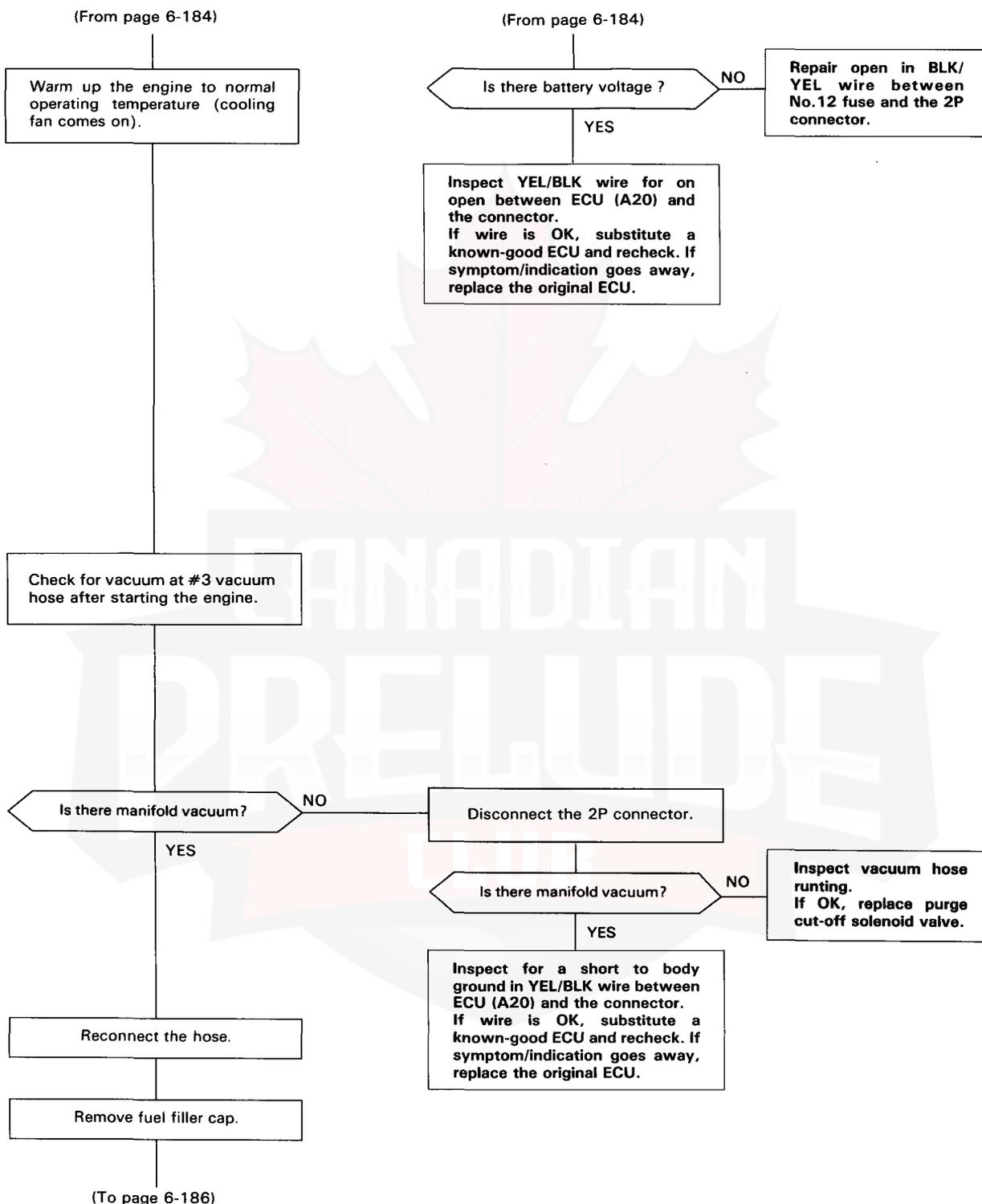

(cont'd)

Emission Control System

Evaporative Emission Controls (cont'd)

(From page 6-185)

Connect a vacuum gauge to canister purge air hose.

Start the engine and raise speed to 3,500 min⁻¹ (rpm).

VACUUM/PRESSURE GAUGE, 0-4 in. Hg

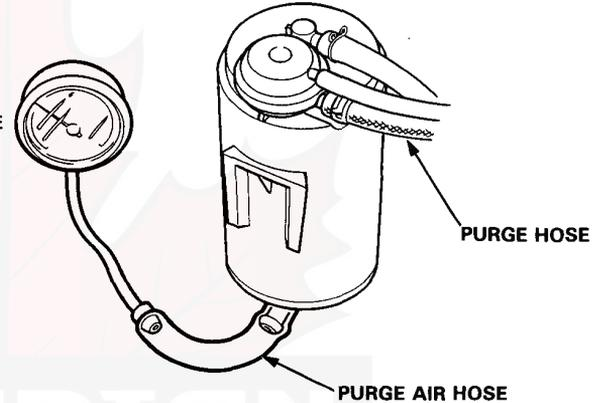

Does vacuum appear on gauge within 1 minute?

NO

Connect a vacuum gauge to the canister purge hose and raise the engine speed to 3,500 min⁻¹ (rpm).

YES

See two-way valve test to complete. Evaporative emission control are OK.

Does vacuum appear on the gauge?

NO

Inspect the purge hose and throttle body port for pinch or blockage.

YES

Replace the canister.

Transaxle

Clutch

Special Tools	7-2
Release Bearing and Release Fork	7-3
Pressure Plate	7-4
Clutch Disc	7-5
Flywheel	7-6
Flywheel and Clutch Disc	7-6

Manual Transmission

Transmission	8-1
Differential	8-15

Automatic Transmission

Transmission	9-1
Differential	9-115

Driveshafts

Special Tools	10-2
Driveshafts	10-3
Intermediate Shaft	10-6

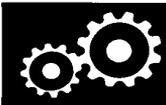

Clutch

Special Tools	7-2
Release Bearing and Release Fork	7-3
Pressure Plate	7-4
Clutch Disc	7-5
Flywheel	7-6
Flywheel and Clutch Disc	7-6

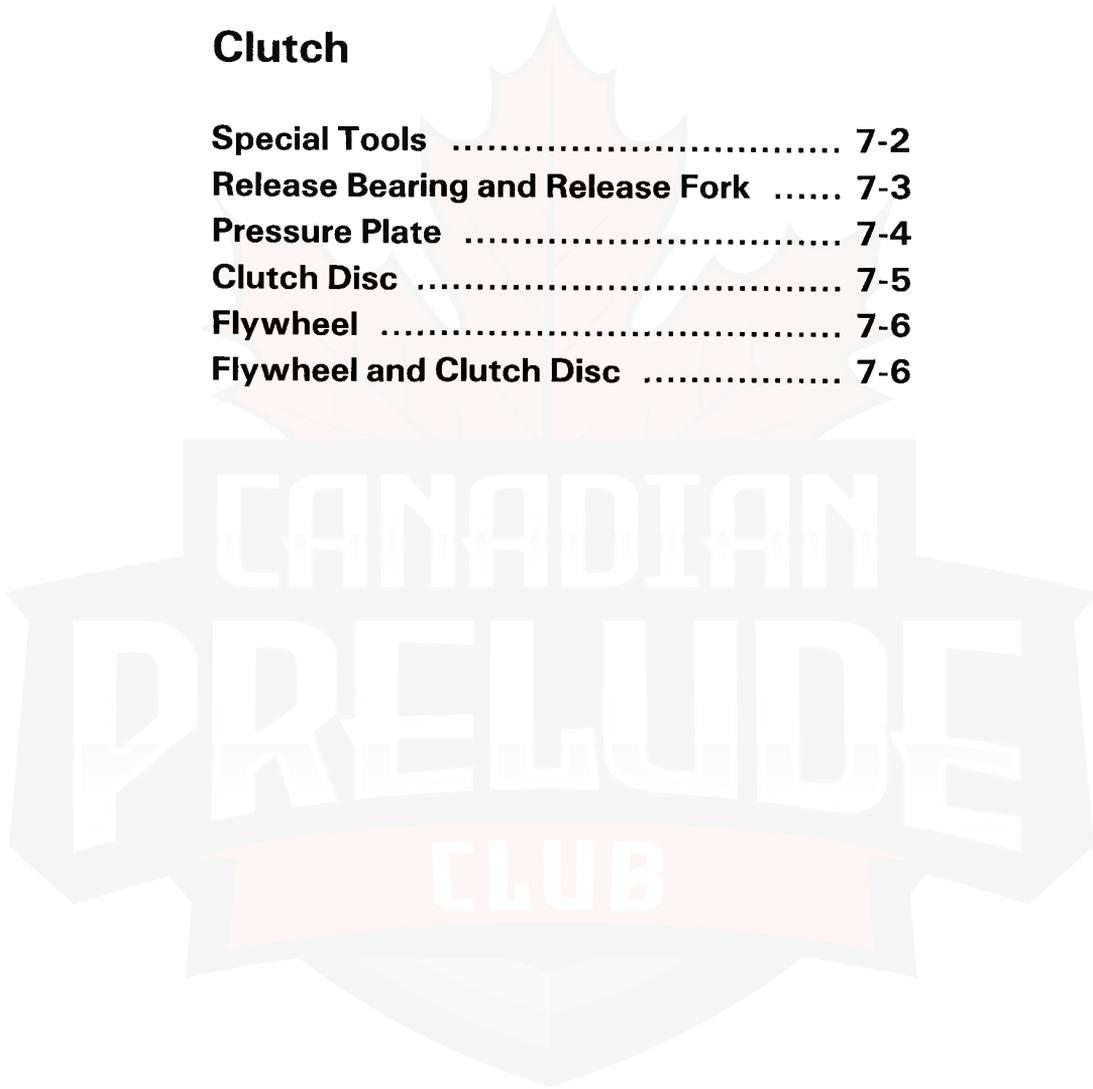

Outline of Model Changes

- Maintenance procedures have been added due to application of set spring to release fork.
- Maintenance procedures have also been added to accommodate changes to the size of the mainshaft splines.

Special Tools

Ref. No.	Tool Number	Description	Q'ty	Remarks
①	07JAF-PM7011A	Clutch Alignment Disc	1	7-4
②	07LAF-PT00110	Clutch Alignment Shaft	1	7-4, 7
③	07924-PD20003 or 07924-PD20002	Ring Gear Holder	1	7-4, 5, 6
④	07936-3710100	Handle	1	7-4, 7

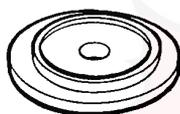

①



②

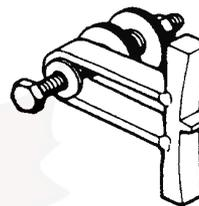

③



④



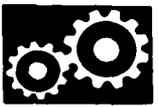

Release Bearing and Release Fork

Disassembly/Inspection

1. Remove the boot from the clutch housing.
2. Remove the release fork from the clutch housing by squeezing the release fork set spring with pliers. Remove the release bearing.

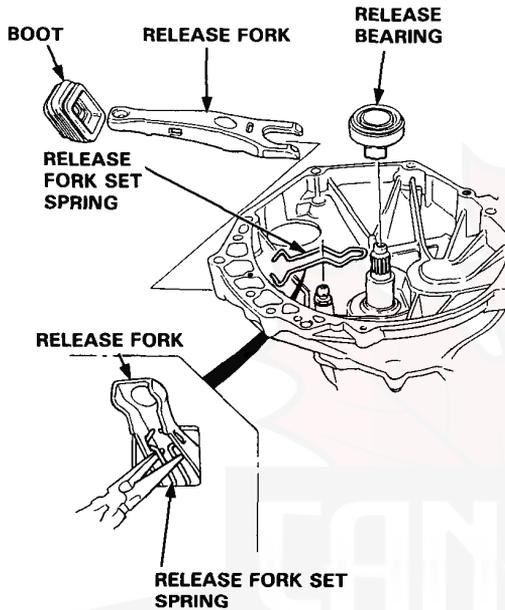

3. Check the release bearing for play by spinning it by hand.

CAUTION: The bearing is packed with grease. Do not wash it in solvent.

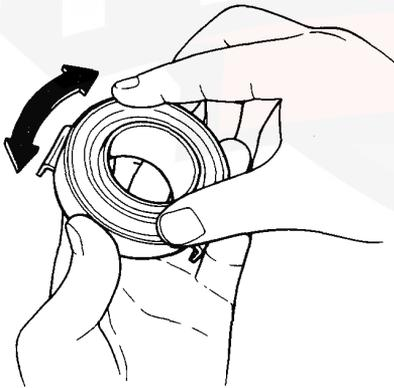

4. Replace the bearing with a new one if there is excessive play.

Installation

1. Install the release fork set spring on the release fork.

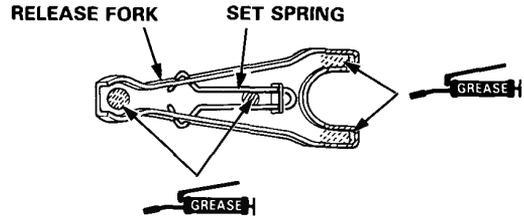

CAUTION: Use only molybdenum disulfide grease in this step (Do not use M77).

2. With the release fork slid between the release bearing pawls, install the bearing on the mainshaft while inserting the release fork through the hole in clutch housing.
3. Align the detent of the release fork with the release fork bolt and press down on the fork on the release fork bolt squarely.

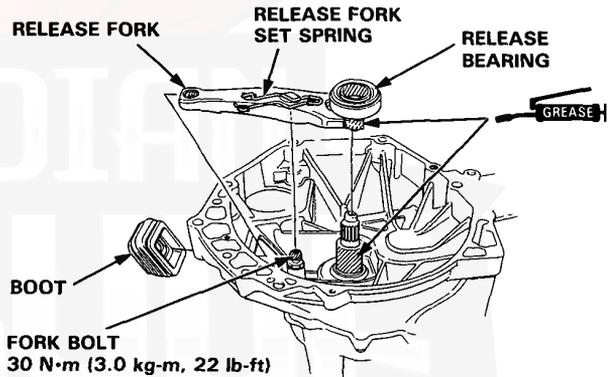

CAUTION: Use only molybdenum disulfide grease in this step (Do not use M77).

4. Install the boot, being sure that there is no clearance: release fork-to-boot, and boot-to-clutch housing.
5. Move the release fork right and left to make sure that the fork fits properly against the bearing, and that the bearing slides smoothly.

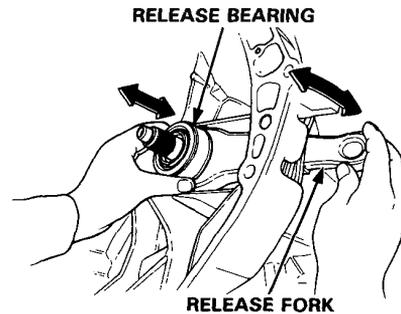

Pressure Plate

Removal/Inspection

1. Inspect the fingers of the diaphragm spring for wear at the release bearing contact area.
2. Assemble the special tools as shown.
NOTE: Assemble the Clutch Alignment Disc with side "A" facing the diaphragm as shown.
3. Check the diaphragm spring fingers for height using the special tools and feeler gauge.

Standard (New): 0.6 mm (0.02 in.) Min.
Service Limit: 0.8 mm (0.03 in.) Max.

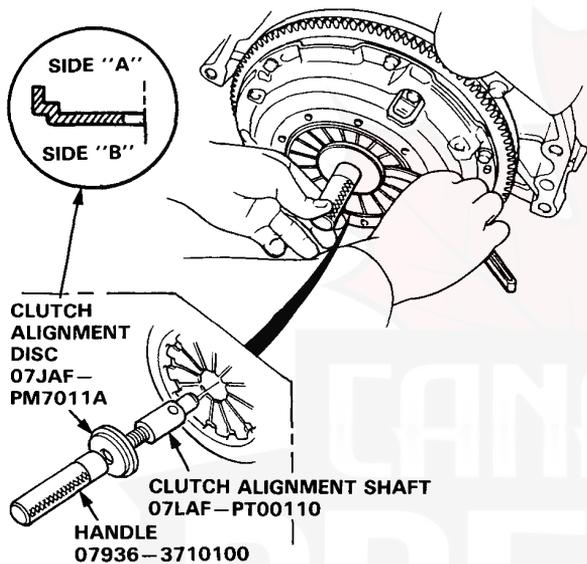

4. Install the Ring Gear Holder.

45 N·m
(4.5 kg-m, 32 lb-ft)

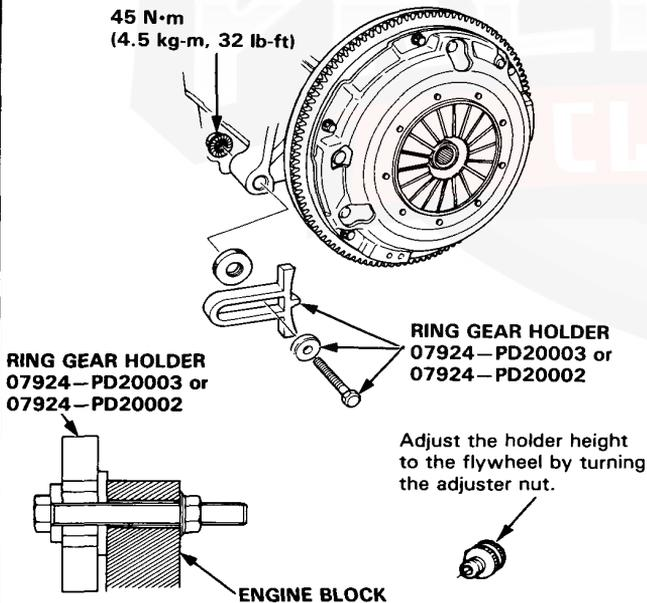

5. To prevent warping, unscrew the pressure plate mounting bolts two turns at a time in a crisscross pattern using a 10 mm T-wrench, then remove the pressure plate and clutch disc.

RING GEAR HOLDER
07924-PD20003 or
07924-PD20002

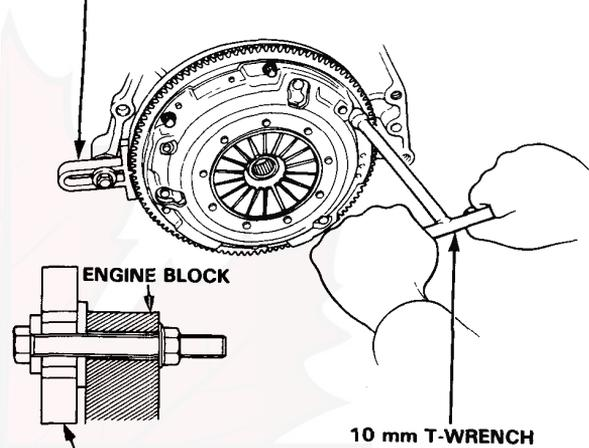

RING GEAR HOLDER
07924-PD20003 or 07924-PD20002

6. Inspect the pressure plate surface for wear, cracks, or burning.
7. Inspect for warpage using a straight edge and feeler gauge.

Standard (New): 0.03 mm (0.001 in.) Min.
Service Limit: 0.15 mm (0.006 in.) Max.

Measure across pressure plate.

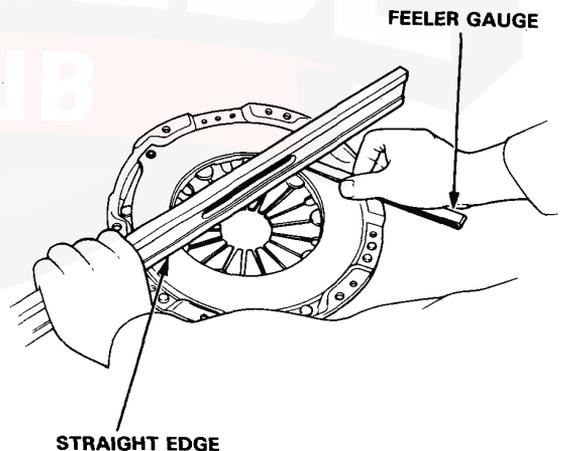



Clutch Disc

Inspection

1. Remove the clutch disc.
2. Inspect lining of the clutch disc for signs of slipping or oil. Replace it if it is burned black or oil soaked.

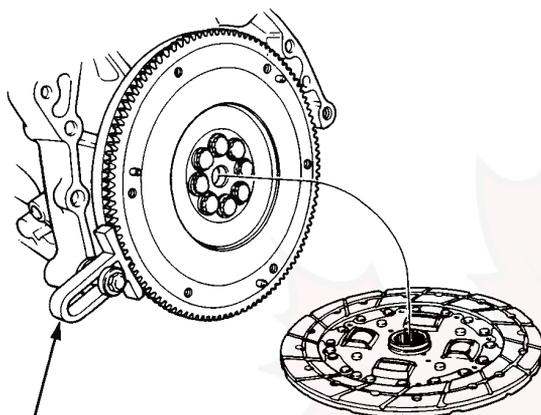

RING GEAR HOLDER
07924-PD20003 or
07924-PD20002

CLUTCH DISC

3. Measure the clutch disc thickness.

Clutch Disc Thickness:

Standard (New): 8.5–9.2 mm (0.33–0.36 in.)

Service Limit: 6.1 mm (0.24 in.)

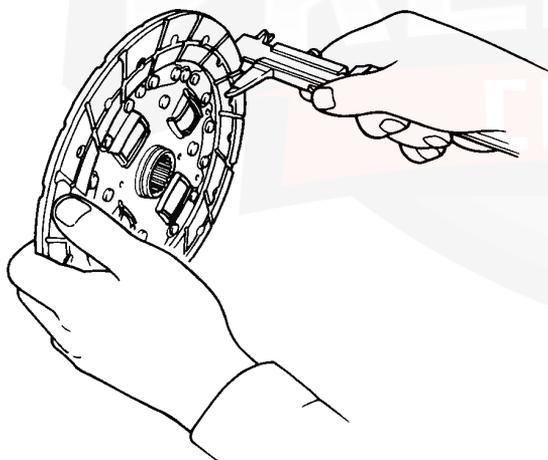

4. Check for loose rubber torsion dampers. Replace the clutch disc if any are loose.
5. Measure the depth from the lining surface to the rivets, on both sides.

Rivet Depth:

Standard (New): 1.3 mm (0.051 in.) min.

Service Limit: 0.2 mm (0.008 in.)

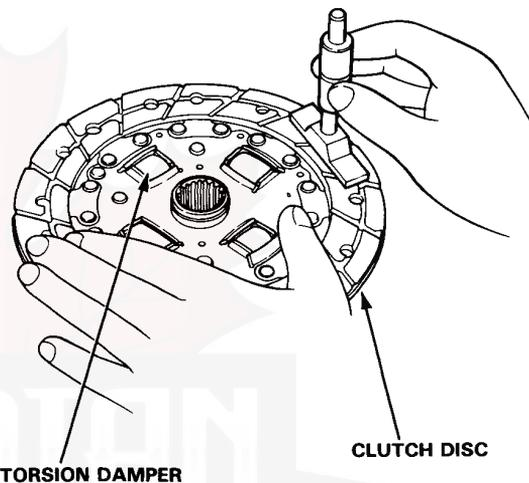

TORSION DAMPER

CLUTCH DISC

Flywheel

Inspection/Removal

1. Inspect the ring gear teeth for wear or damage.
2. Inspect the clutch disc mating surface on the flywheel for wear, cracks or burning.
3. Measure the flywheel runout using a dial indicator through at least two full turns. Push flywheel toward engine to take up the crankshaft thrust washer clearance.

NOTE: The runout can be measured with engine installed.

Standard (New): 0.05 mm (0.002 in.) max.
Service Limit: 0.15 mm (0.006 in.)

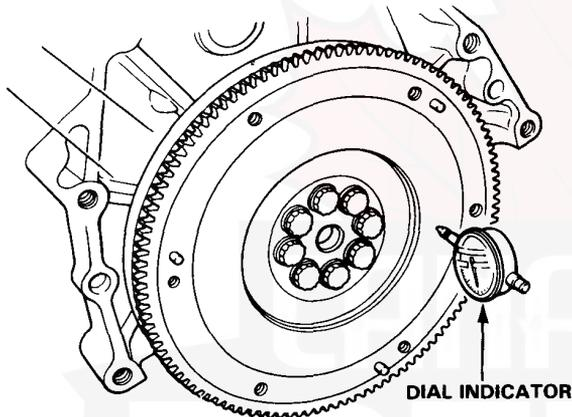

4. Remove the eight flywheel mounting bolts and flywheel.

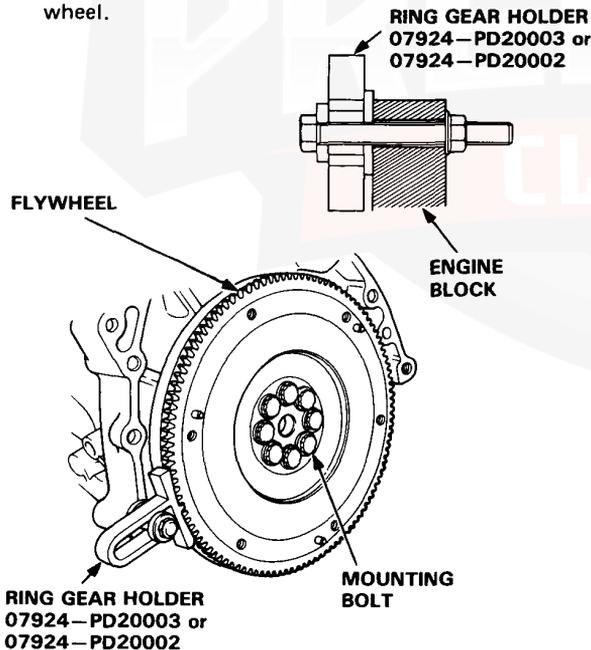

Flywheel and Clutch Disc

Installation

1. Align the hole in flywheel with the crankshaft dowel pin and assemble. Install the bolts only finger tight.
2. Install the Ring Gear Holder, then torque the flywheel bolts in a crisscross pattern, as shown.

RING GEAR HOLDER
07924-PD20003 or 07924-PD20002

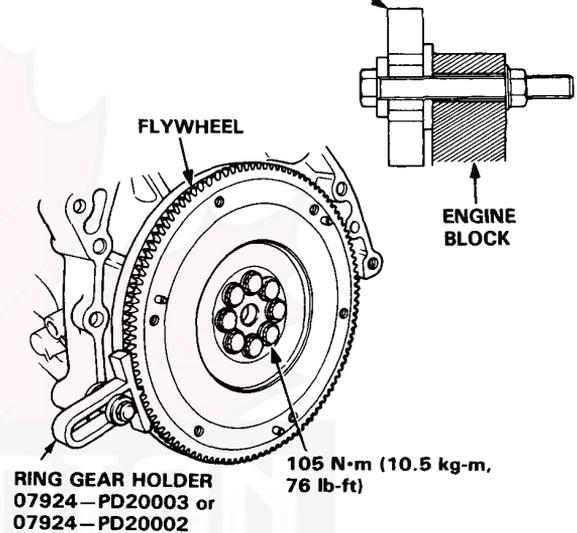

3. Install the clutch disc and pressure plate by aligning the flywheel dowels with dowel holes in the pressure plate.

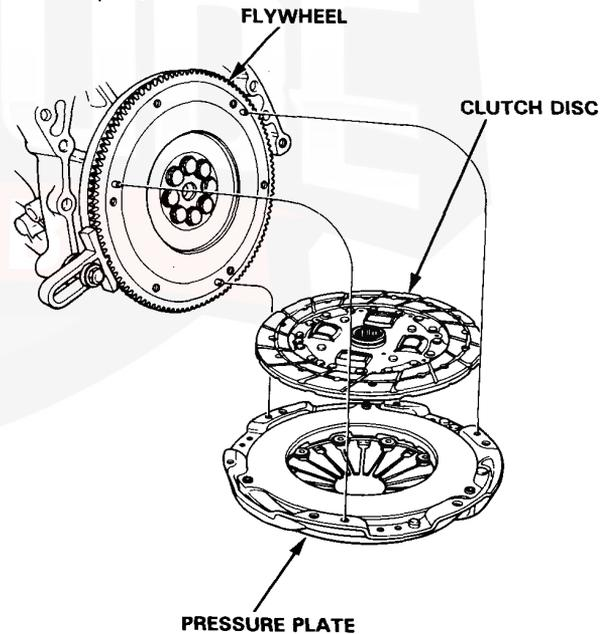

4. Install the attaching bolts finger tight.

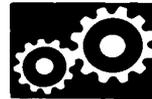

5. Insert the special tool into the splined hole in the clutch disc.

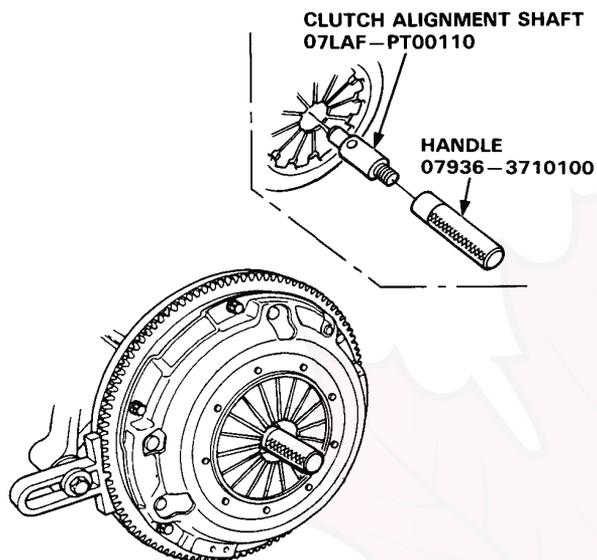

6. Torque the bolts in a crisscross pattern as shown. Tighten them two turns at a time to prevent warping the diaphragm spring.

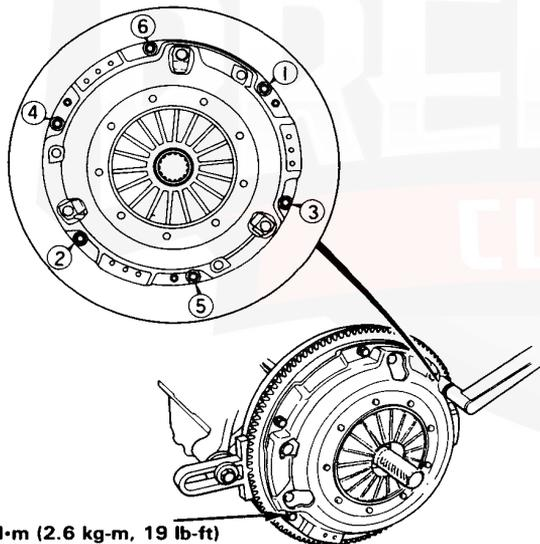

7. Remove the Alignment Tool and Ring Gear Holder.

Manual Transmission

Transmission 8-1

Differential 8-15

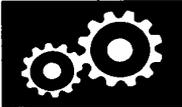
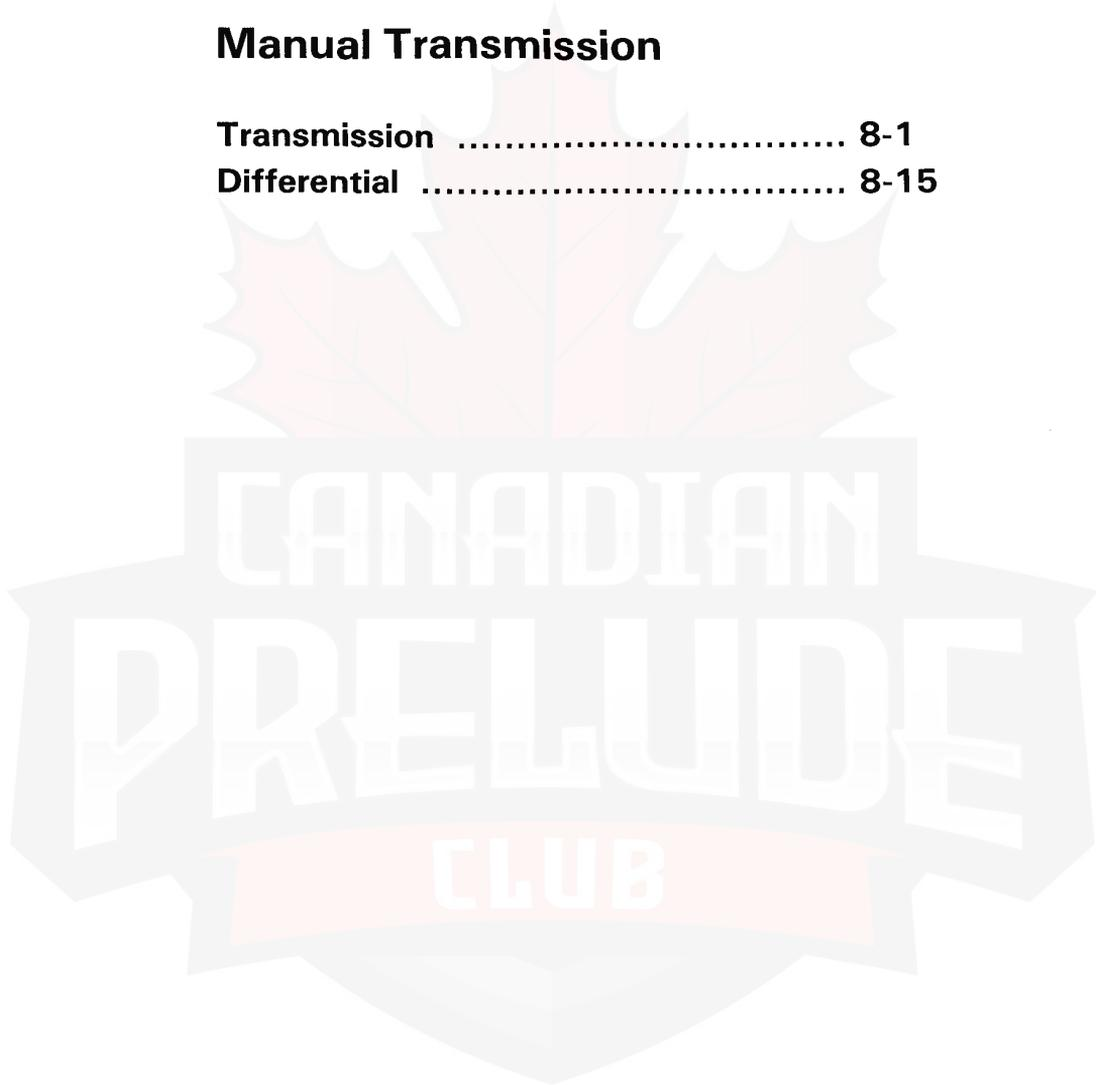

Transmission

* The internal construction of the D2 Manual Type Transmission uses the same construction as the H2U5 or H2C4. For this reason, reference is to be made to the relative topic under H2U5 or H2C4 in the Maintenance Edition No. 62PX500 for the items other than those shown in this manual.

Maintenance	8-2
Transmission Assembly	
Removal	8-2
Illustrated Index	8-6
Shift Arm Assembly	
Index	8-8
Reassembly	8-9
Back-up Light Switch	
Replacement	8-11
Transmission Assembly	
Installation	8-11

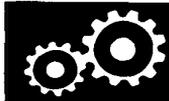

Outline of Model Changes

- Texts as to oil maintenance have been shown due to change to the transmission.
- The descriptions as to removal and installation of the transmission have been added due to change to the transmission.
- Exploded view and titles for shift arm Assembly and backup light switch have also been shown.

Maintenance

Transmission Oil

Oil Level Inspection

1. Check with oil at operating temperature, engine OFF, and car on level ground.
2. Remove oil filler plug and check level with finger.
3. Oil level must be up to fill hole. If it is below hole, add oil until it runs out, then reinstall plug.

OIL FILLER PLUG
45 N·m (4.5 kg-m, 33 lb-ft)

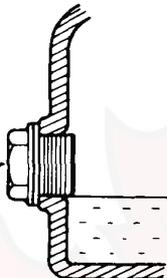

Oil Change

Use only SAE 10W-30 or 10W-40 oil rated SE or SF grade.

1. With transmission oil at operating temperature, engine OFF, and car on level ground, remove drain plug and drain transmission.
2. Reinstall drain plug with new washer, and refill to proper level.

NOTE: Drain plug washer should be replaced at every oil change.

Oil Capacity

- 2.1 l (2.2 U.S. qt.) after drain.
- 2.2 l (2.3 U.S. qt.) after overhaul.

OIL FILLER PLUG
45 N·m (4.5 kg-m, 33 lb-ft)

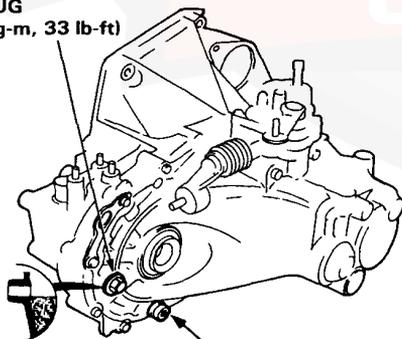

DRAIN PLUG
40 N·m (4.0 kg-m, 29 lb-ft)

Transmission Assembly

Removal

1. Disconnect the ground cable at the battery and the transmission.
2. Disconnect the wiring for:
 - Starter motor.
 - Back-up light switch
3. Remove the air cleaner case (PGM-FI only).
4. Remove the power steering speed sensor from the transmission without removing the power steering hoses.
5. Remove the shift cable and the select cable from the top cover of the transmission. Remove the mounting bolt from the cable stay.

NOTE:

Do not bend or kink the cable more than necessary. Remove both cables and the stay together.

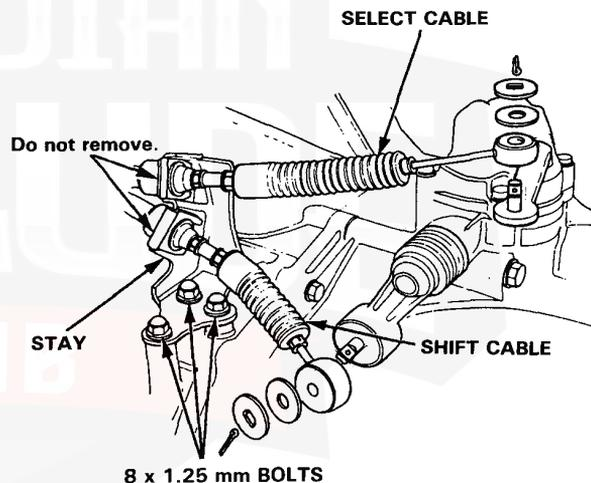

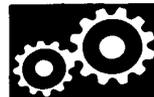

6. Remove the upper transmission mounting bracket.

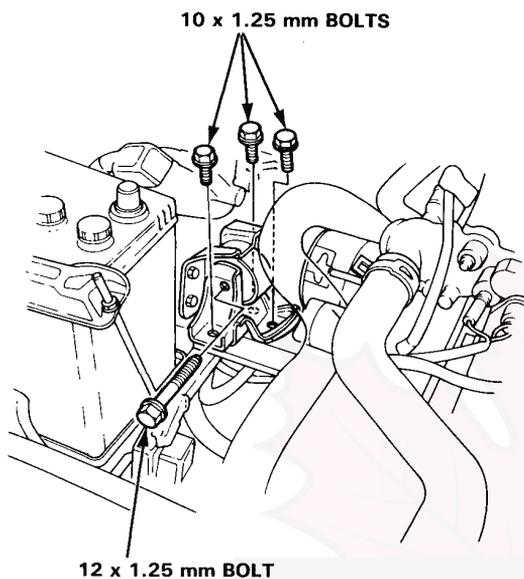

7. Remove the 4 transmission-to-block attachment bolts that must be removed from the engine compartment.

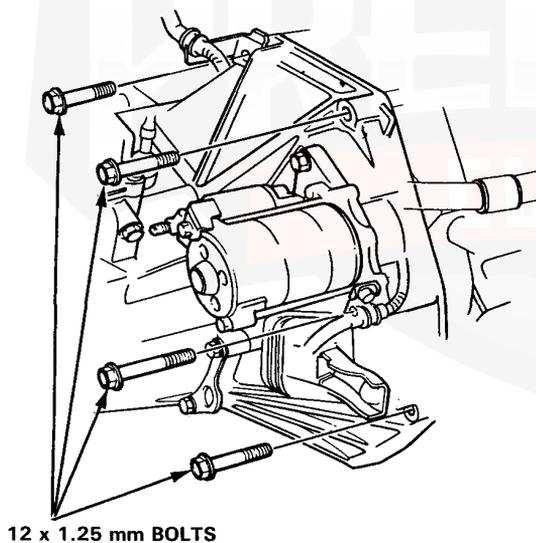

8. Raise the vehicle from reinforced lift points.
9. Remove both front wheels.
10. Remove the undercarriage splash shield.
11. Drain transmission oil.
12. Remove the clutch slave cylinder.

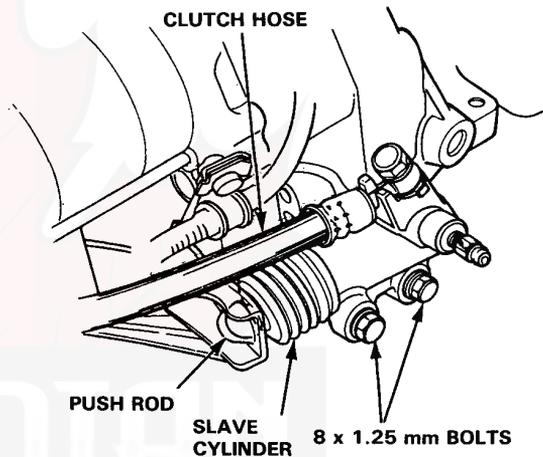

13. Remove the center beam.

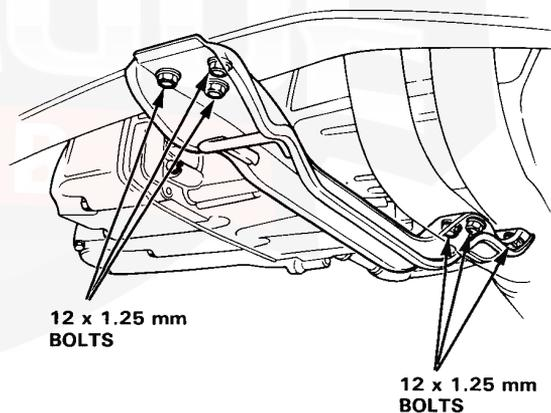

(cont'd)

Transmission Assembly

Removal (cont'd)

14. Remove the right radius rod completely.
15. Remove right and left drive shaft.
16. Remove the intermediate shaft.

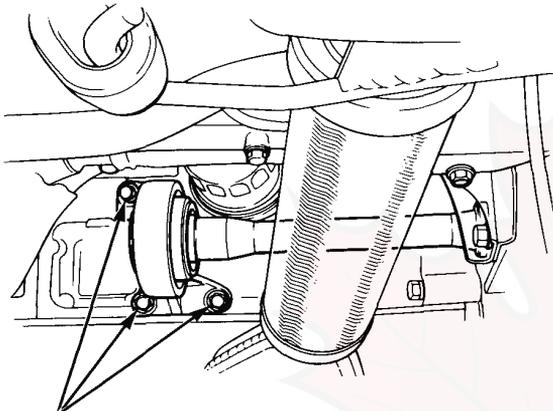

10 x 1.25 mm BOLTS

17. Remove the engine stiffener.

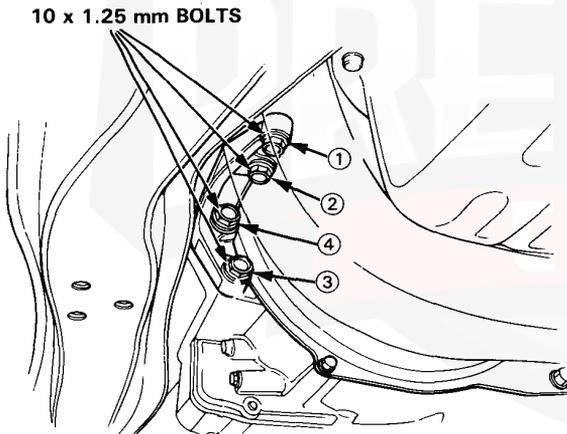

10 x 1.25 mm BOLTS

18. Remove the clutch cover.

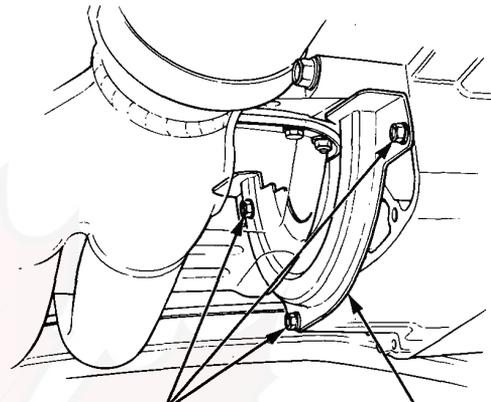

6 x 1.0 mm BOLTS CLUTCH COVER

19. Support transmission with an appropriate jack.
20. Remove the 3 lower bolts from the rear engine mounting bracket.
Loosen but do not remove the top bolt. This bolt will support the weight of the engine.

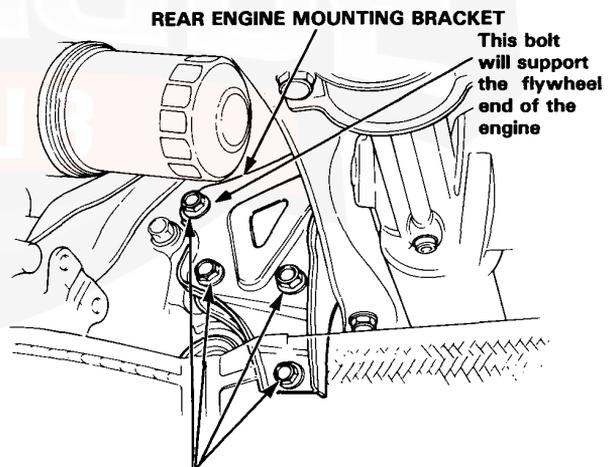

REAR ENGINE MOUNTING BRACKET
12 x 1.25 mm SPECIAL BOLTS
Replace

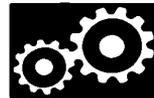

21. Remove the 2 remaining engine-to-transmission mounting bolts.

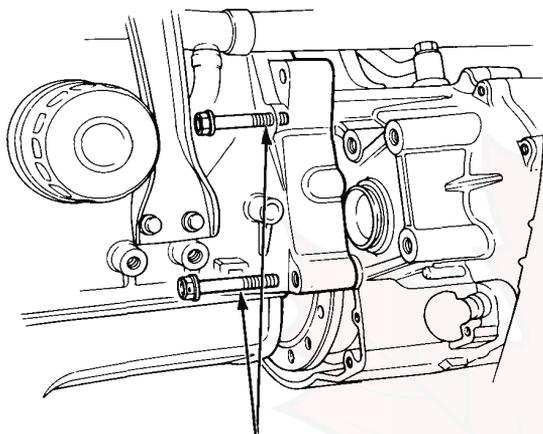

12 x 1.25 mm BOLTS
Replace

22. With the transmission on an appropriate jack, disengage the input shaft from the clutch disc.

Illustrated Index

Clean all parts thoroughly in solvent and dry with compressed air.



Lubricate all parts with oil before reassembly.

NOTE: This transmission uses no gaskets between the major housings; use Honda Genuine liquid gasket (P/N OY746-99986).

Assemble the housings within 20 minutes after applying the sealant and allow it to cure at least 30 minutes after assembly before filling the transmission with oil.

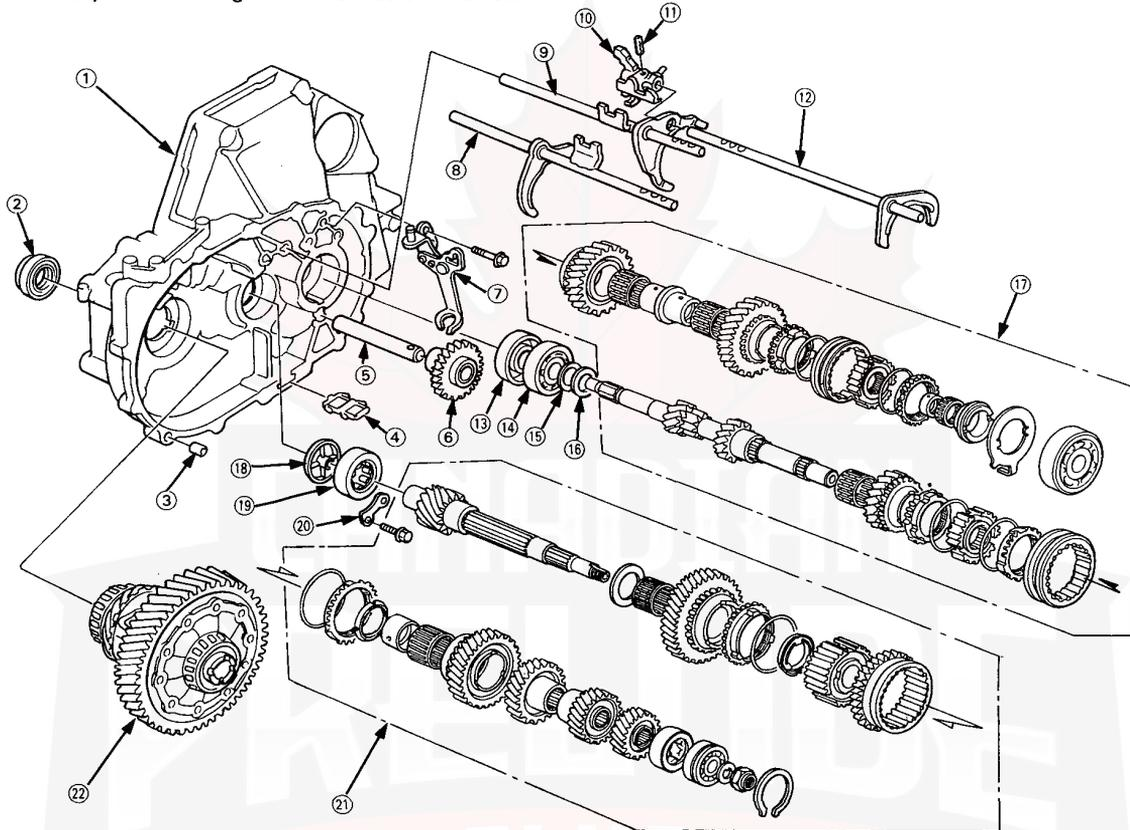

- ① CLUTCH HOUSING
- ② OIL SEAL
- ③ DOWEL PIN
- ④ MAGNET
- ⑤ REVERSE IDLER GEAR SHAFT
- ⑥ REVERSE IDLER GEAR
- ⑦ REVERSE SHIFT FORK
- ⑧ 1st/2nd SHIFT FORK
- ⑨ 3rd/4th SHIFT FORK
- ⑩ 5th/REVERSE SHIFT PIECE

- ⑪ SPRING PIN
- ⑫ 5th SHIFT FORK
- ⑬ OIL SEAL
- ⑭ BALL BEARING
- ⑮ SPRING WASHER
- ⑯ WASHER
- ⑰ MAIN SHAFT ASSEMBLY
- ⑱ OIL GUIDE PLATE

- ⑲ NEEDLE BEARING
- ⑳ RETAINING PLATE
- ㉑ COUNTER SHAFT ASSEMBLY
- ㉒ DIFFERENTIAL ASSEMBLY

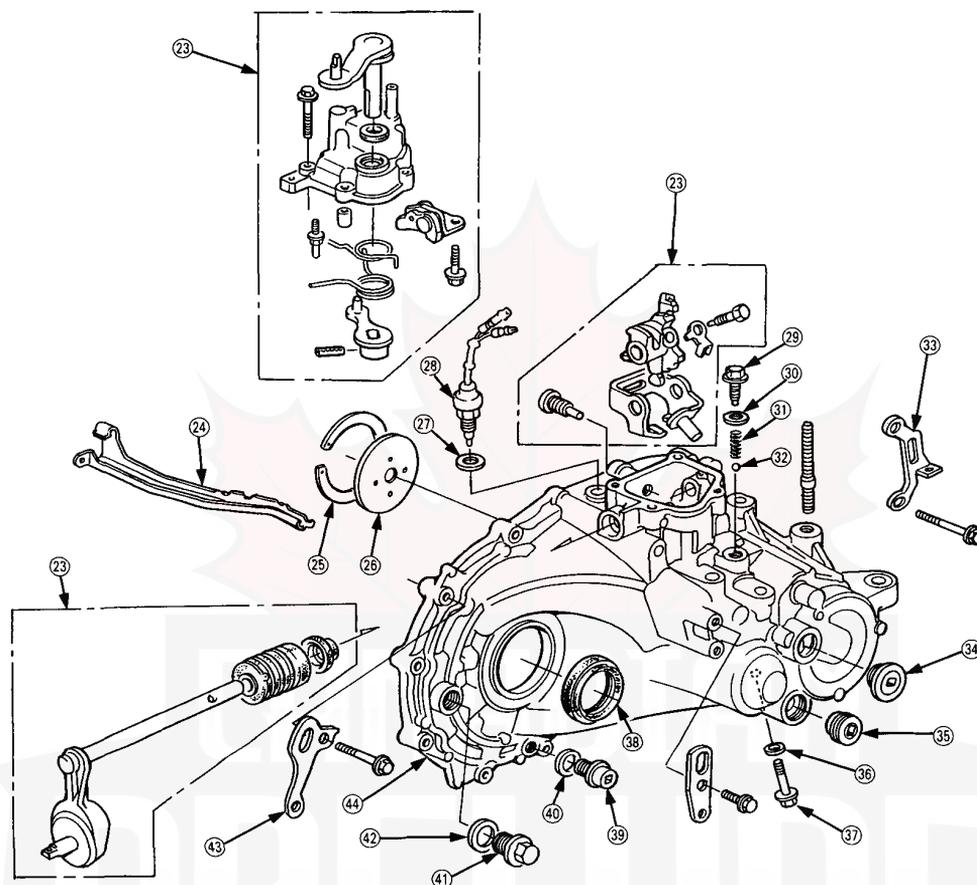
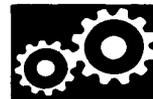

23 SHIFT ARM ASSEMBLY

• Index, page 8-8

24 OIL GUTTER PLATE

25 THRUST SHIM

26 OIL GUIDE PLATE

27 WASHER

28 BACK-UP LIGHT SWITCH

29 SETTING SCREW

30 WASHER

31 SPRING

32 STEEL BALL

33 TRANSMISSION HANGER

34 28 mm SEALING BOLT

35 32 mm SEALING BOLT

36 WASHER

**37 REVERSE IDLER GEAR
SHAFT BOLT**

38 OIL SEAL

39 OIL DRAIN PLUG

40 WASHER

41 OIL FILLER BOLT

42 WASHER

43 TRANSMISSION HANGER

44 TRANSMISSION HOUSING

Shift Arm Assembly

Index

NOTE:

- The shift arm cover can be removed and installed with the transmission in the car.
- Lubricate all moving and sliding surfaces with grease.

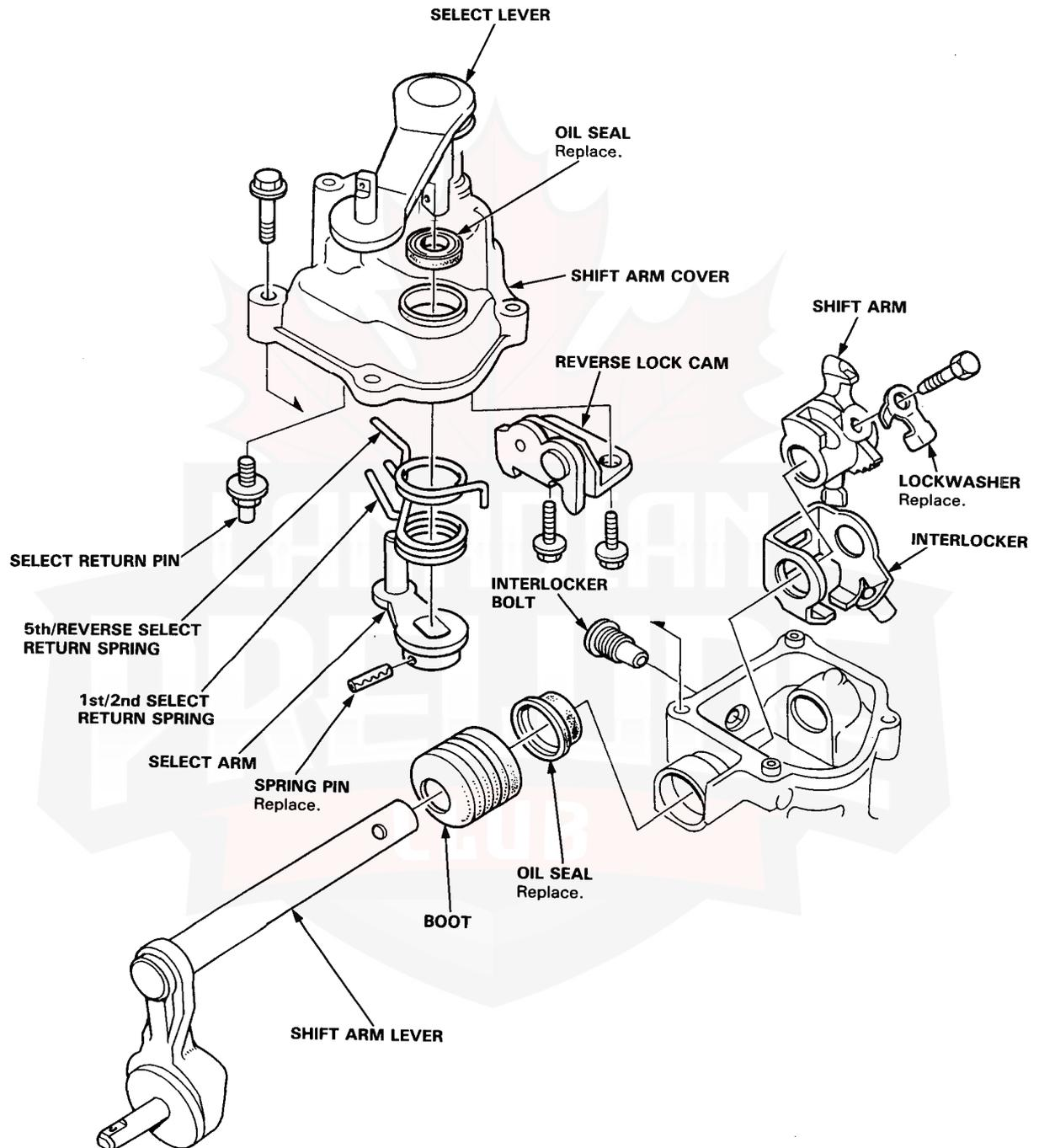

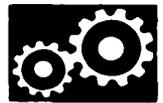

Reassembly

NOTE: During reassembly, grease all sliding parts.

1. Install the oil seal in the shift arm cover.

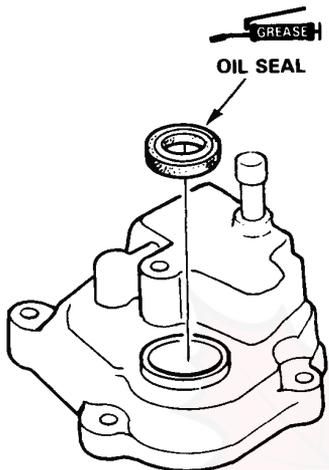

2. Install the reverse lock cam.

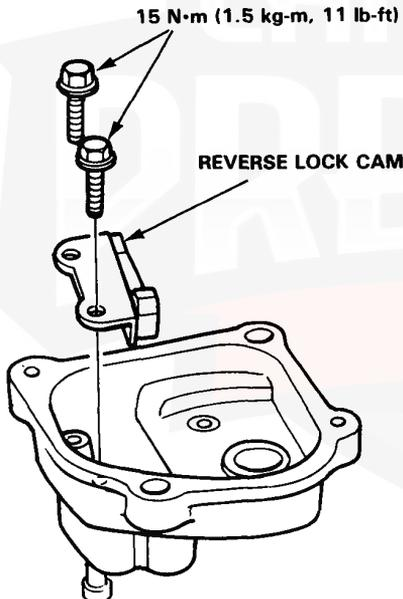

3. Insert the select lever into the select arm then, press the spring pin into the select arm and lever with pliers.

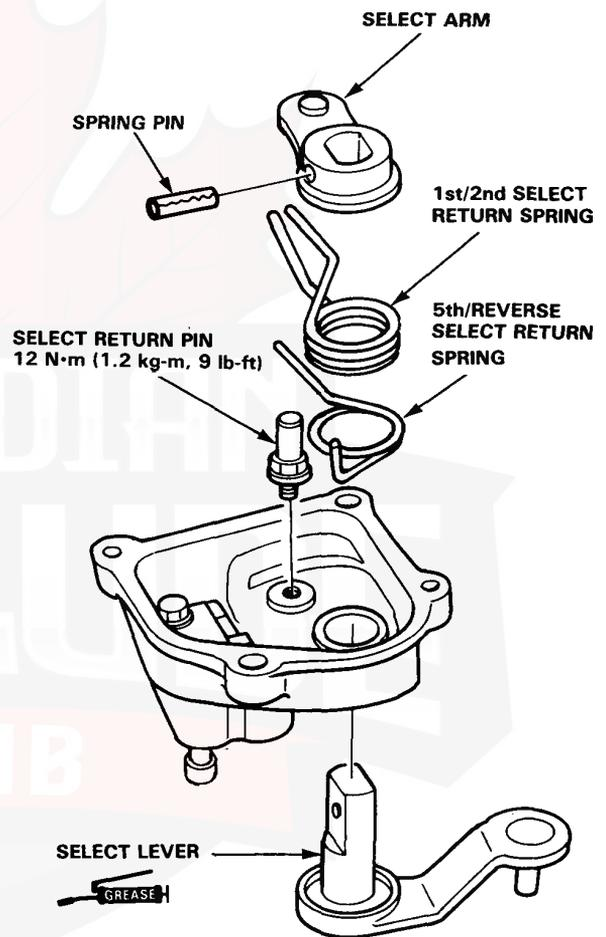

(cont'd)

Shift Arm Assembly

Reassembly (cont'd)

- Place the boot onto the shift arm lever.
- Insert the shift arm into the interlocker.
- Insert the shift lever through the shift arm and interlocker.

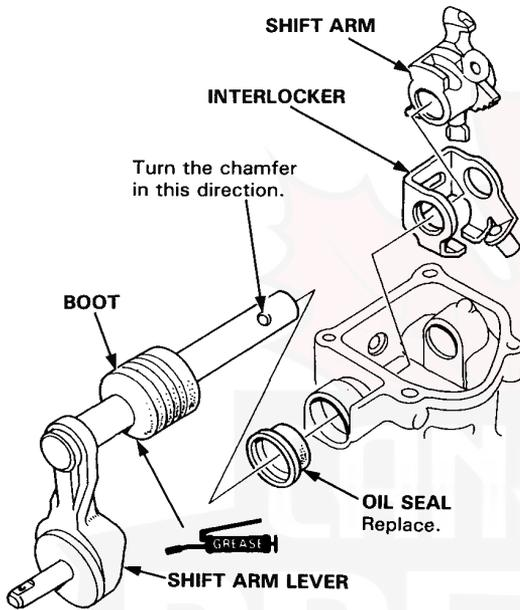

- Insert the interlocker bolt into the interlocker, then tighten the interlocker bolt.
- Align shift arm and shift arm lever holes, then insert and tighten the 8 mm bolt.

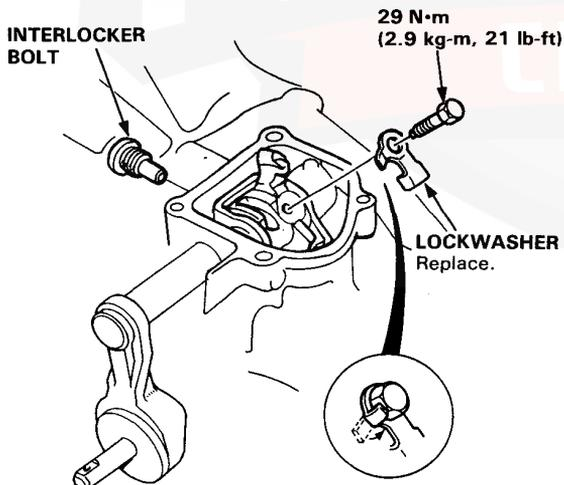

- During replacement, apply a liquid gasket sealing compound on the sealing surface between the shift arm cover assembly and the transmission housing.

CAUTION:

- Use PART NO. OY746-99986 for the liquid gasket.
- Remove all dirt and oil from the sealing surface.
- Apply liquid gasket on the central part of the sealing surface.
- Seal the entire circumference of the bolt hole to prevent oil leakage.
- When the sealing surface has remained untouched for more than 20 minutes after application of the liquid gasket, do not replace the parts without sealing the surface again.
- Refill the oil after 30 minutes after replacement.

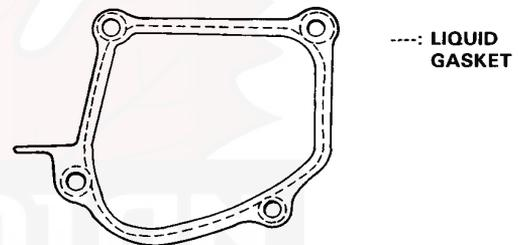

- Install the dowl pins.
- Install the shift arm cover assembly.

12 N·m (1.2 kg-m, 9 lb-ft)

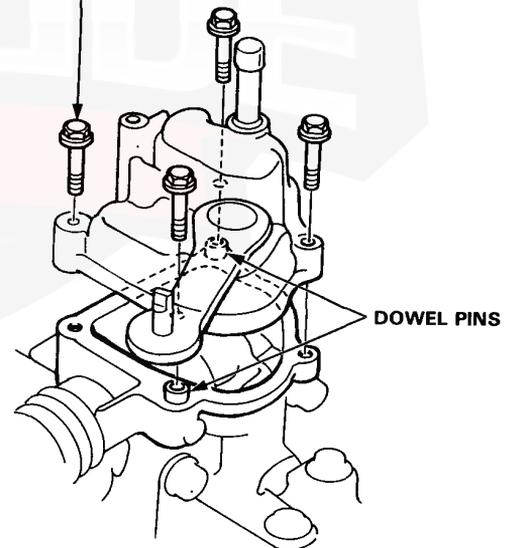

Back-up Light Switch

Replacement

NOTE: Check the switch.

1. Disconnect the back-up light switch wire connectors.
2. Remove the back-up light switch.

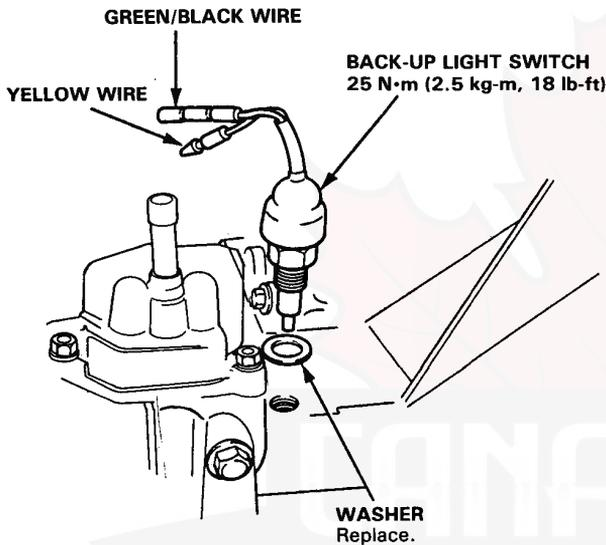

3. Install the new washer and back-up light switch.

Transmission Assembly

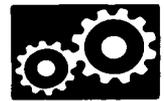

Installation

1. Attach the 14 mm dowel pin to the transmission.
2. Support the transmission with a jack or by some other means.
3. Tighten the transmission mount bolt on the engine side.

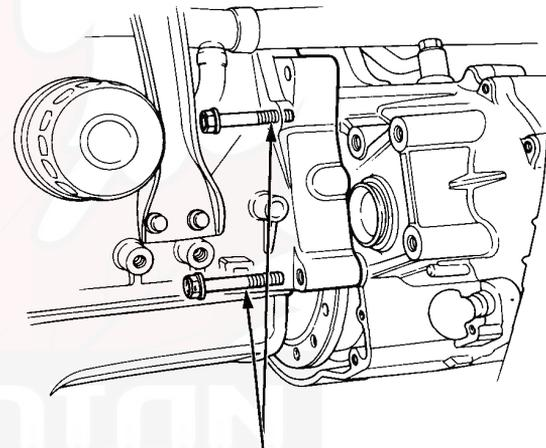

12 x 1.25 mm BOLT
65 N·m (6.5 kg·m, 47 lb-ft)
Replace

4. Tighten the transmission mount bolt on the transmission side.

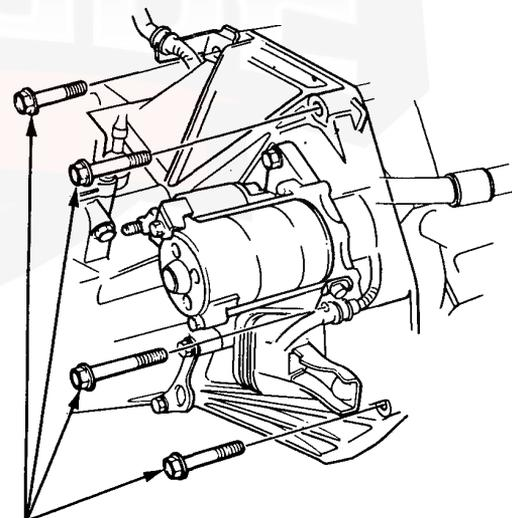

12 x 1.25 mm BOLT
65 N·m (6.5 kg·m, 47 lb-ft)

(cont'd)

Transmission Assembly

Installation (cont'd)

5. Attach the transmission mounting bracket.

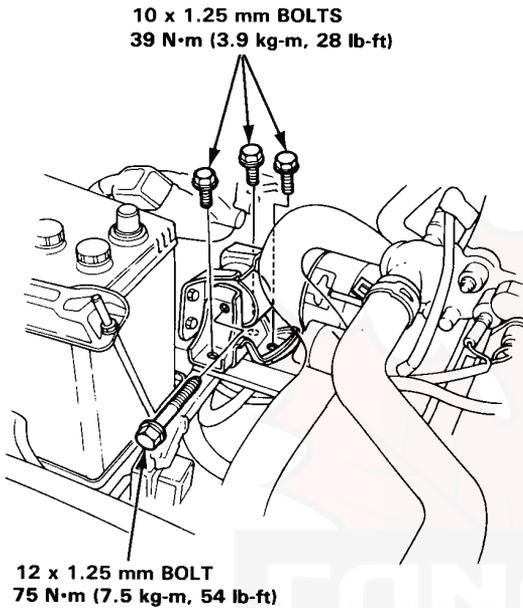

6. Attach the transmission fixing bolt to the rear engine mounting bracket and tighten it.

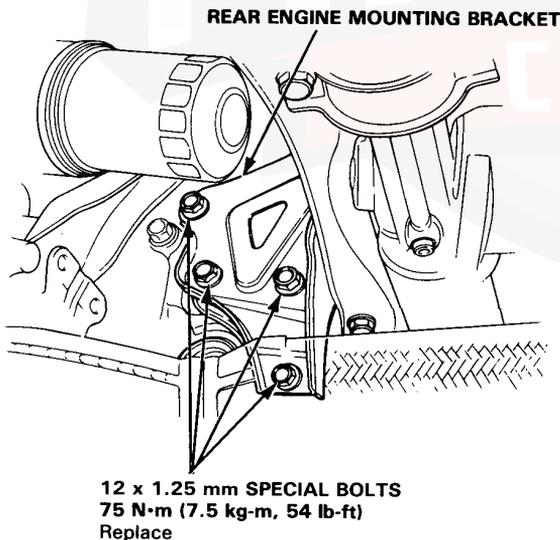

7. Attach the clutch cover.

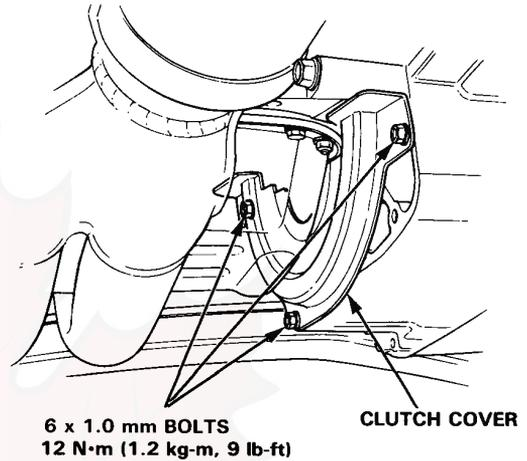

8. Attach the engine stiffener.

NOTE: Tighten bolts ① to ④ in order to torque specified below.

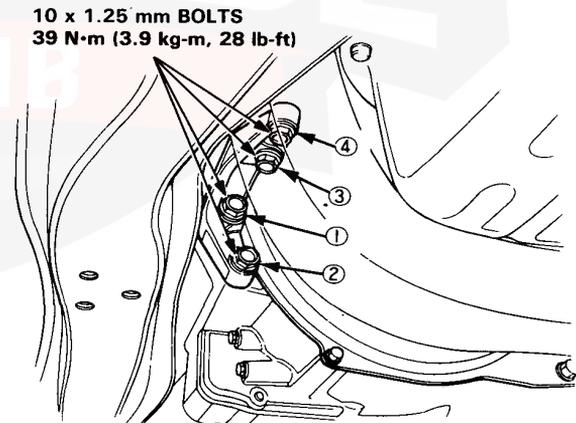

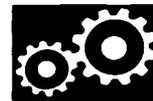

- 9. Attach the intermediate shaft.
- 10. Attach the right and left drive shaft.

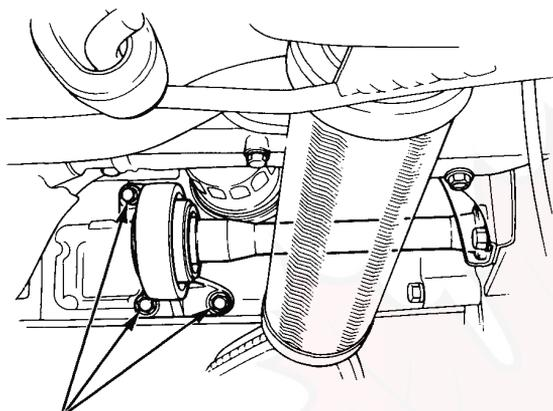

10 x 1.25 mm BOLT
39 N·m (3.9 kg-m, 28 lb-ft)

- 11. Attach the center beam.

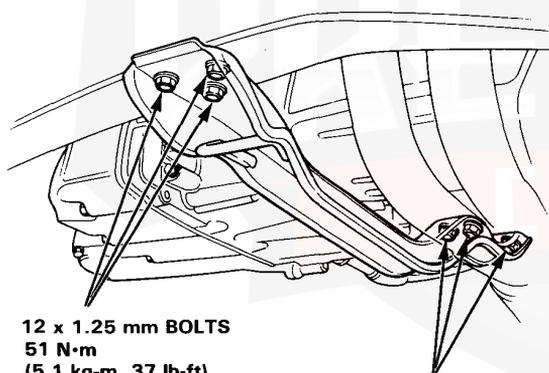

12 x 1.25 mm BOLTS
51 N·m
(5.1 kg-m, 37 lb-ft)

12 x 1.25 mm BOLTS
51 N·m
(5.1 kg-m, 37 lb-ft)

- 12. Attach the clutch slave cylinder with the clutch hose and push rod.

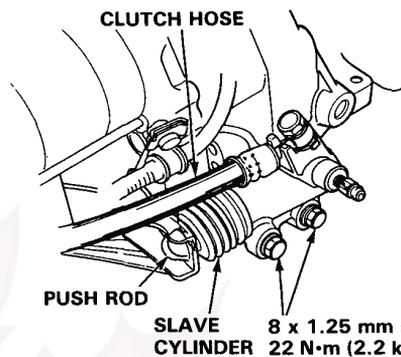

SLAVE CYLINDER **8 x 1.25 mm BOLT**
22 N·m (2.2 kg-m, 16 lb-ft)

- 13. Attach the transmission side shift cable and select cable to the shift arm lever and to select lever respectively.
- 14. Connect the back-up light switch coupler.
- 15. Attach the right and left front damper forks.
- 16. Attach the speed sensor assembly.
- 17. Attach the air cleaner case.
- 18. Connect the starter motor cable and the ground cable.
- 19. Connect the battery wire through the positive terminal.
- 20. Attach the front wheels.
- 21. Refill transmission with oil.

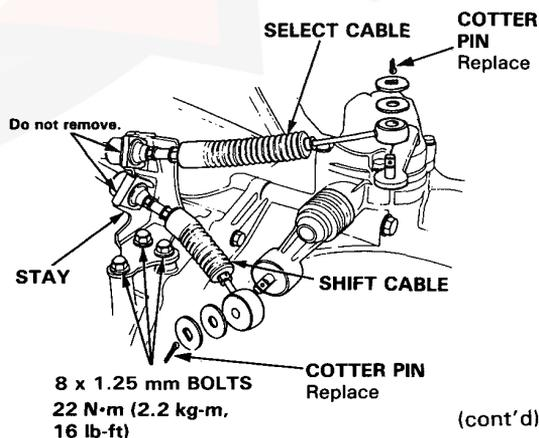

8 x 1.25 mm BOLTS
22 N·m (2.2 kg-m,
16 lb-ft)

COTTER PIN
 Replace

(cont'd)

Transmission Assembly

Installation (cont'd)

22. Check and adjust the following items after reassembly.

- 1. Transmission has been refilled.
- 2. The clip at the tip of the drive shaft is completely inserted into the groove of the differential or intermediate shaft.
- 3. Clutch free play.
- 4. Shift the change to check, by the change lever, if the gears are properly enmeshed.

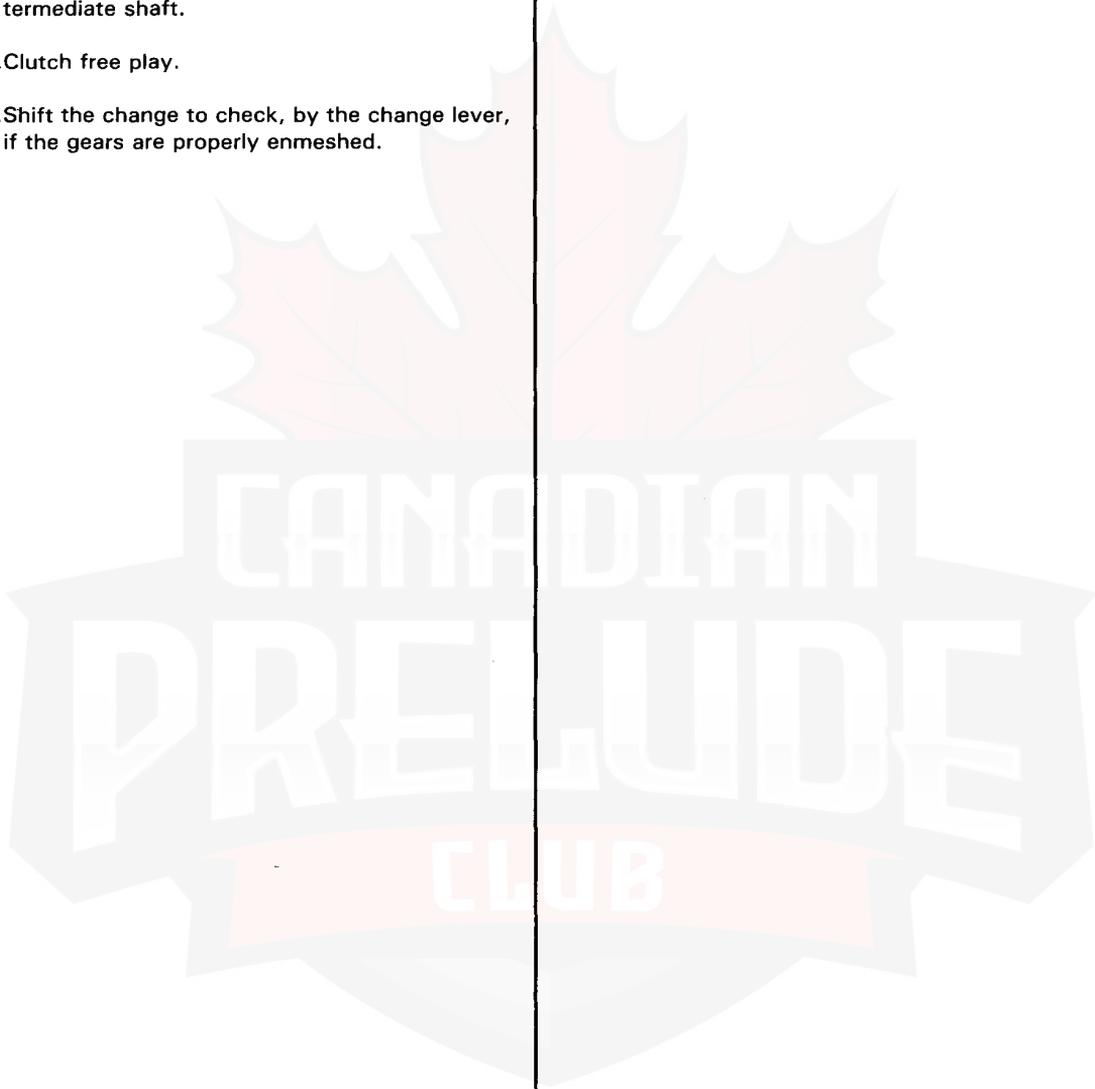

Differential

Special Tools	8-16
Illustrated Index	8-17
Backlash Inspection	8-18
Bearing Replacement	8-18
Inspection/Disassembly	8-19
Reassembly	8-20
Oil Seal Removal	8-21
Bearing Outer Race Replacement	8-22
Taper Roller Bearing Preload Adjustment	8-23
Oil Seal Installation	8-25

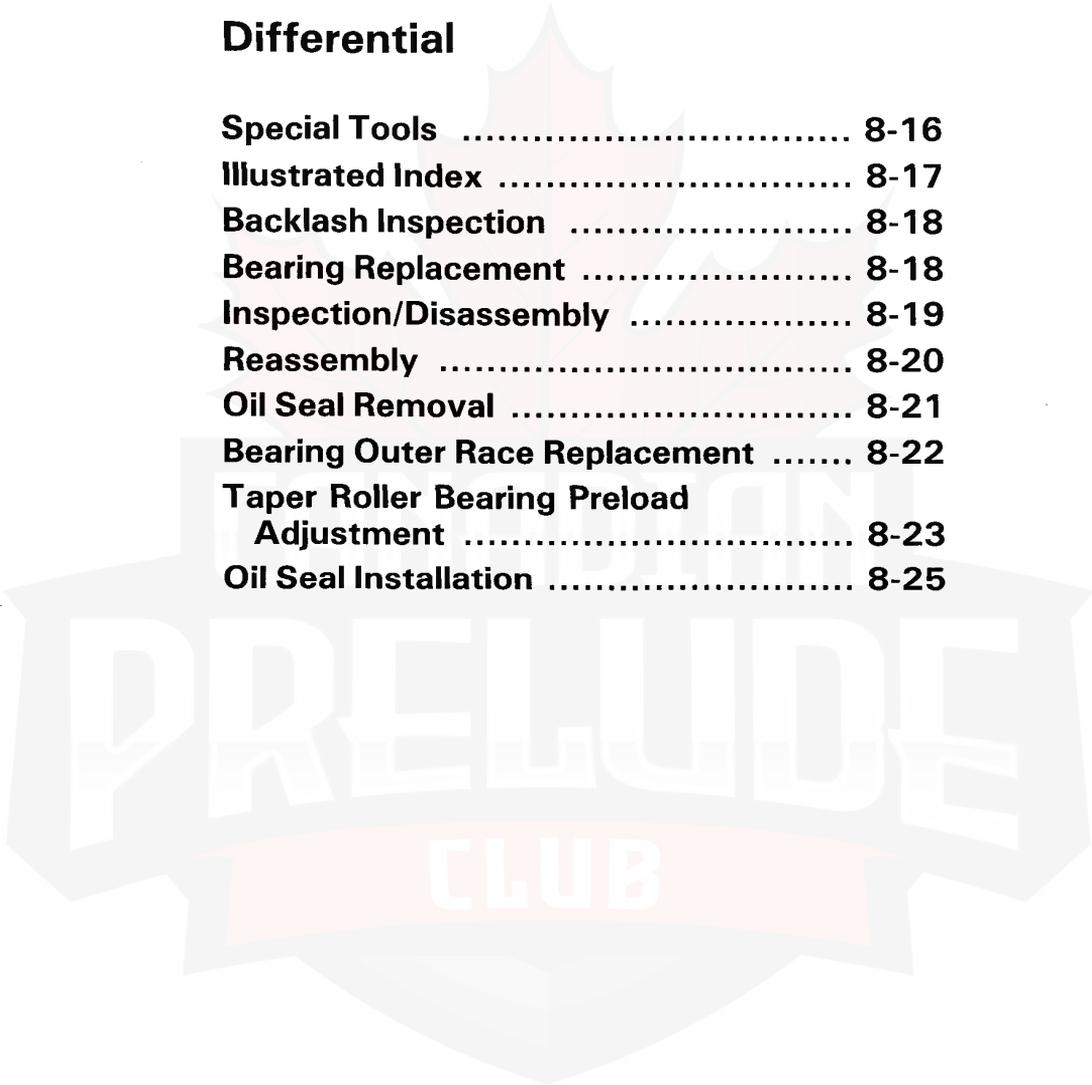
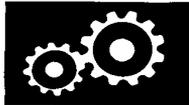

Outline of Model Changes

- The maintenance procedures and special tools have been added due to change to the taper roller bearing.
- The maintenance procedures have been added due to change to the method of staking the pinion shaft.
- The maintenance procedures and special tool have been added to change to the oil seal.

Special Tools

Ref. No.	Tool Number	Description	Q'ty	Remarks
①	07JAF-SH20200	Ball Joint Remover Base	1	8-18
②	07HAJ-PK40201	Preload Inspection Tool	1	8-24
③	07JAD-PH80101	Seal Driver Attachment	1	8-25
④	07JAD-PH80400	Pilot Driver 28 mm	1	8-25
⑤	07746-0010400	Attachment, 52 x 55 mm	1	8-22
⑥	07746-0010500	Attachment, 62 x 68 mm	1	8-22
⑦	07746-0010600	Attachment, 72 x 75 mm	1	8-22
⑧	07749-0010000	Driver	1	8-22, 25
⑨	07947-SD90100	Seal Driver Attachment	1	8-25
⑩	07944-SA00000	Pin Driver 4.0 mm	1	8-19, 20

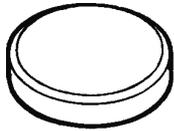

①

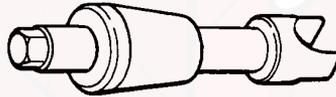

②

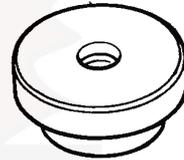

③



④

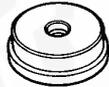

⑤



⑥

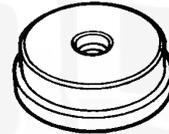

⑦

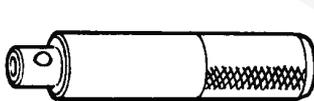

⑧



⑨

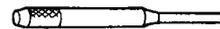

⑩

Differential

Illustrated Index

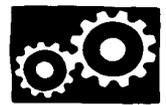

NOTE: If the * mark parts were replaced, the bearing preload must be adjusted (page 8-23).

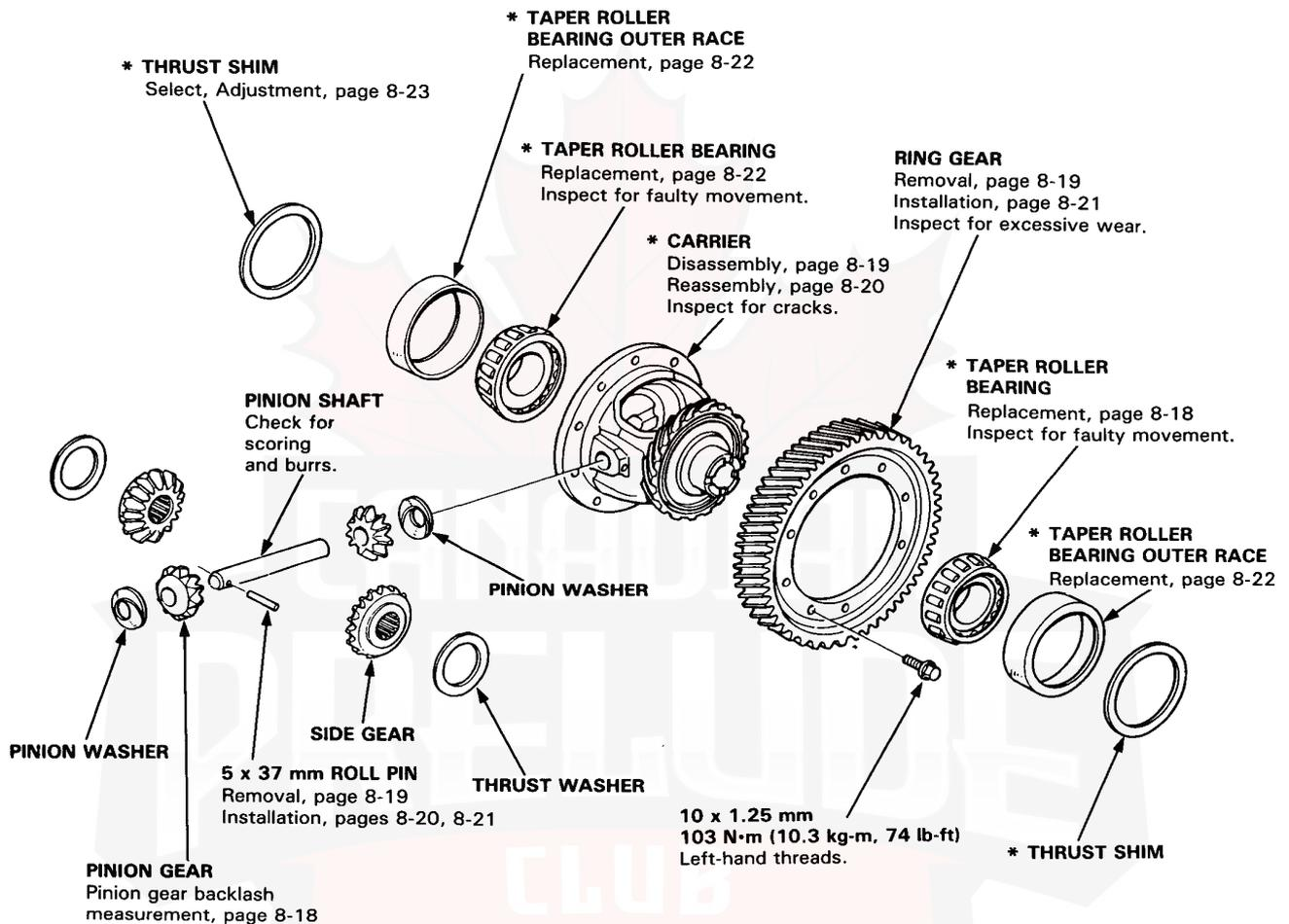

Differential

Backlash Inspection

1. Place differential assembly on V-blocks and install both axles.
2. Check backlash of both pinion gears.

Standard (New): 0.05–0.15 mm
(0.002–0.006 in.)

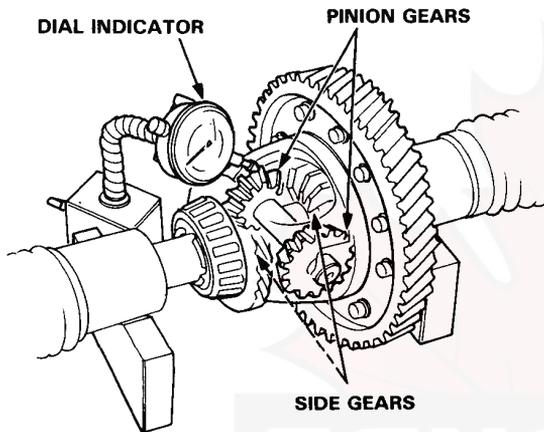

3. If out of tolerance, disassemble differential and select new thrust washers as shown on page 8-20.
4. Measure clearances in the A and B position of the drive pinion.

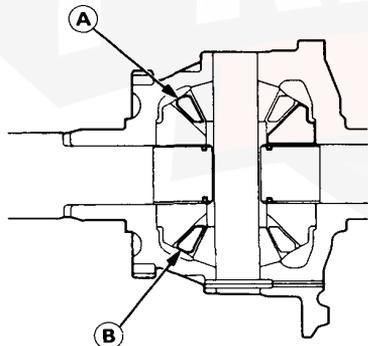

Bearing Replacement

NOTE: Check bearings for wear and rough rotation. If bearings are OK, removal is not necessary.

1. Remove bearings using a standard bearing puller.

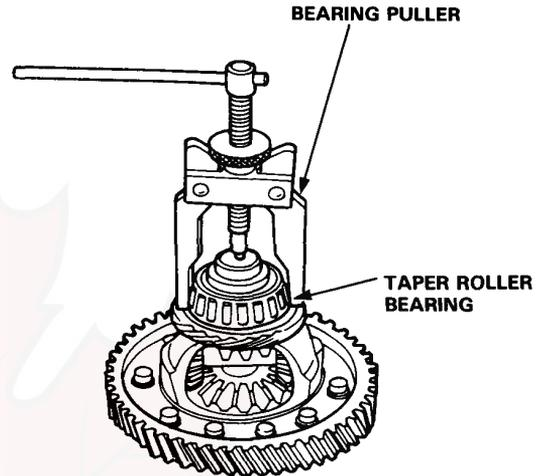

2. Install new bearings using the special tool.

NOTE: Press the bearings squarely until they bottom against the case.

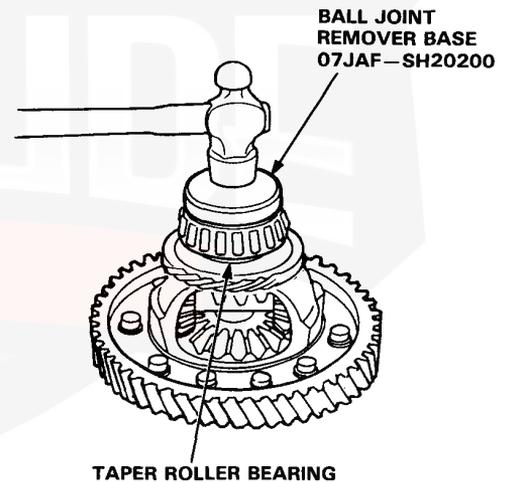

NOTE:

- The bearing and outer race should be replaced as a pair.
- Inspect and adjust the bearing preload whenever the bearing is replaced.

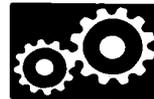

Inspection/Disassembly

1. Remove ring gear and inspect teeth for wear or damage.

CAUTION: Ring gear bolts have left-hand threads.

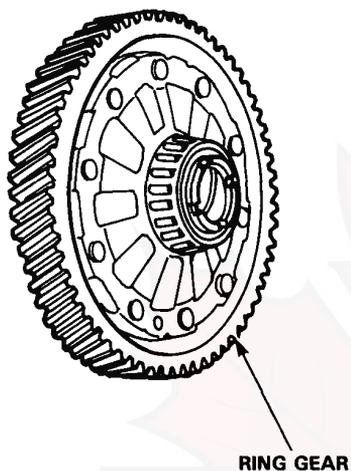

2. Drive out 5 x 37 mm roll pin with a pin Driver.

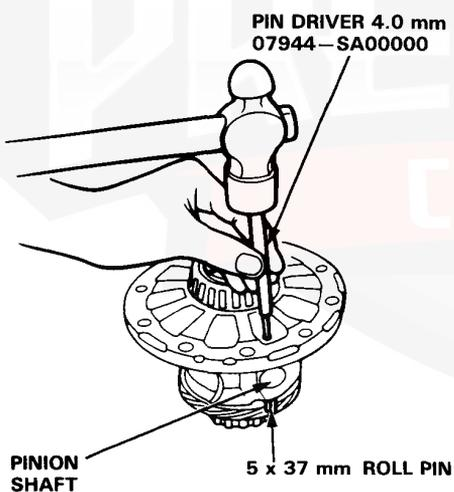

3. Remove pinion shaft, pinion gears, side gears, and thrust washers.

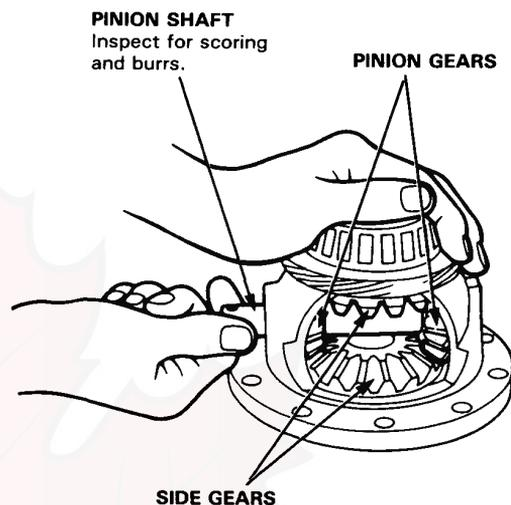

4. Wash parts thoroughly in solvent and dry with compressed air. Inspect all parts for wear or damage and replace any that are defective.

Differential

Reassembly

1. Install the side gears with thrust washers in differential carrier.

CAUTION: Coat all gears with molybdenum disulfide grease on all sides.

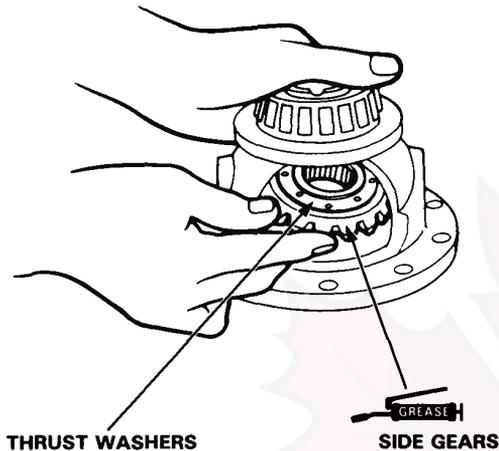

2. Set pinion gears in place exactly opposite each other in mesh with side gears, then install a pinion washer behind each one. Washers must be of equal thickness.

Pinion Washers

PART NUMBER	THICKNESS
41351-PG1-000	0.7 mm (0.028 in)
41352-PG1-000	0.75 mm (0.030 in)
41353-PG1-000	0.8 mm (0.031 in)
41354-PG1-000	0.85 mm (0.033 in)
41355-PG1-000	0.9 mm (0.035 in)
41356-PG1-000	0.95 mm (0.037 in)
41357-PG1-000	1.0 mm (0.039 in)
41358-PG1-000	1.05 mm (0.041 in)

PINION GEAR

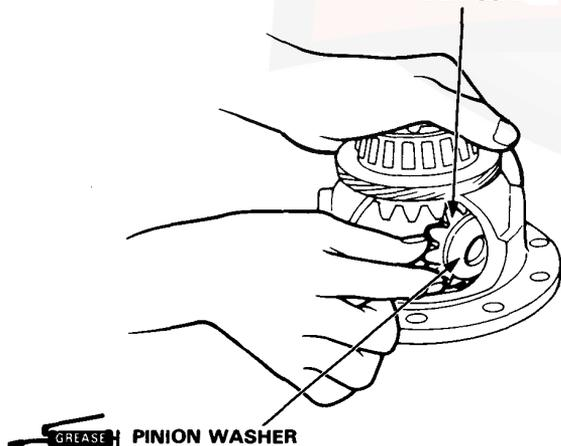

3. Rotate gears as shown until shaft holes in pinion gears line up with shaft holes in carrier.
4. Insert pinion shaft and align roll pin hole in one end with matching hole in carrier.

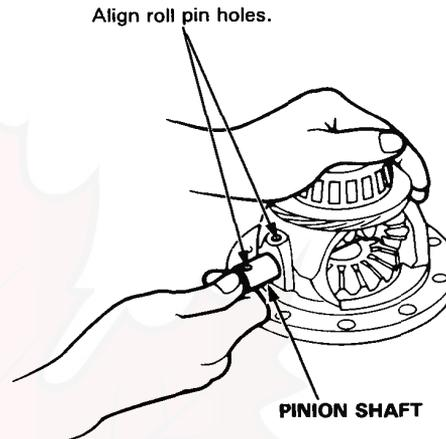

5. Drive in the 5 x 37 mm roll pin with a pin Driver.

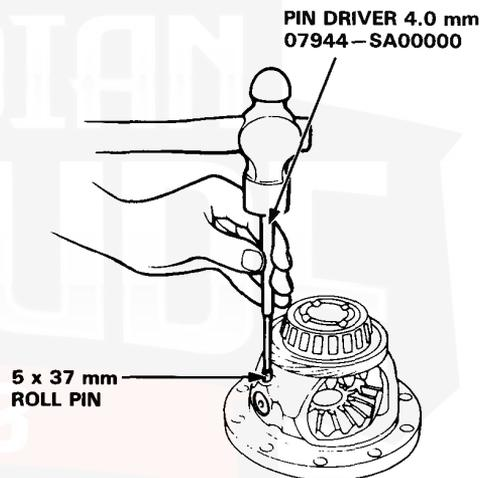

6. Check backlash of both pinion gears again.

**Standard (New): 0.05–0.15 mm
(0.002–0.006 in.)**

- If still out of tolerance, replace thrust washers, then recheck backlash.
- If still out of tolerance, replace side and pinion gears, and recheck backlash.
- If still out of tolerance, replace carrier assembly.

NOTE: If the carrier assembly was replaced, the bearing preload must be adjusted (page 8-23).

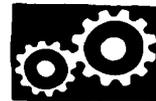

7. Stake the differential carrier at two points.

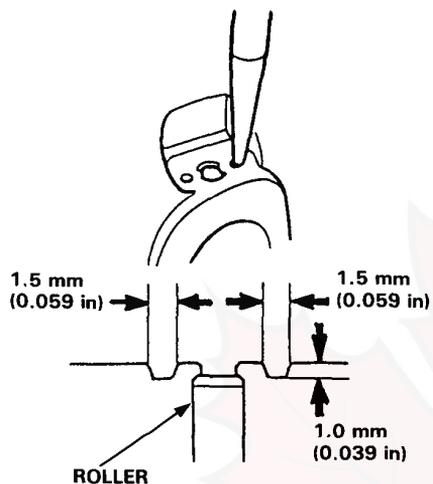

8. Install the ring gear. Torque bolts to 103 N·m (10.3 kg·m, 74 lb·ft).

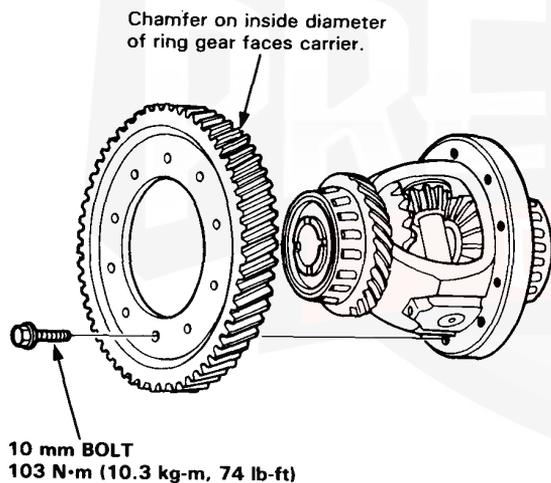

CAUTION: Ring gear bolts have left-hand threads.

Oil Seal Removal

1. Remove the differential assembly.
2. Remove the oil seal from the transmission housing.

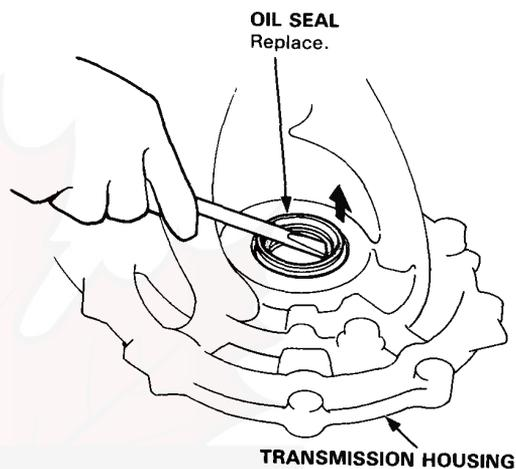

3. Remove the oil seal from the clutch housing.

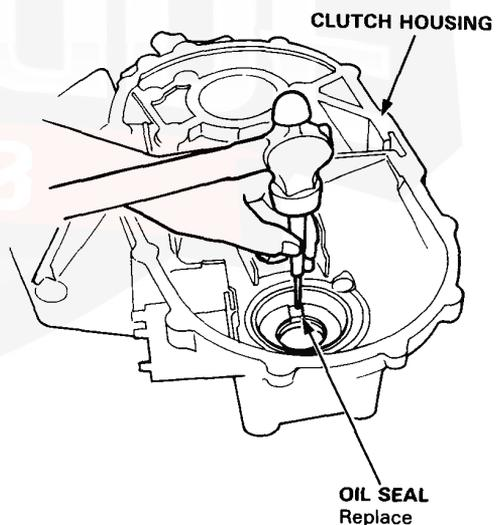

Differential

Bearing Outer Race Replacement

NOTE:

- The outer race and bearing should be replaced as a pair.
- Inspect and adjust the bearing preload whenever the bearing is replaced.

1. Remove the oil seals from the transmission housing and clutch housing (page 8-21).
2. Remove the bearing outer race and thrust shim from the transmission housing, or remove the outer race and shim from the transmission housing by heating the housing to about 100°C (212°F) with a heat gun.

CAUTION: Do not reuse the thrust shim if the outer race was pried out.

NOTE: Do not heat the transmission housing in excess of 100°C (212°F).

TRANSMISSION HOUSING:

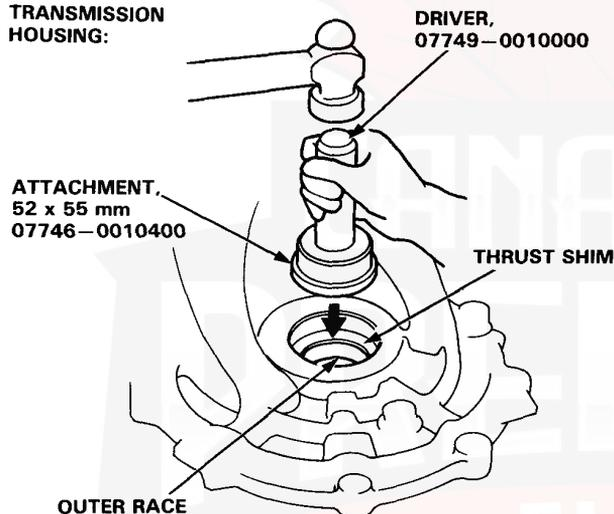

CLUTCH HOUSING:

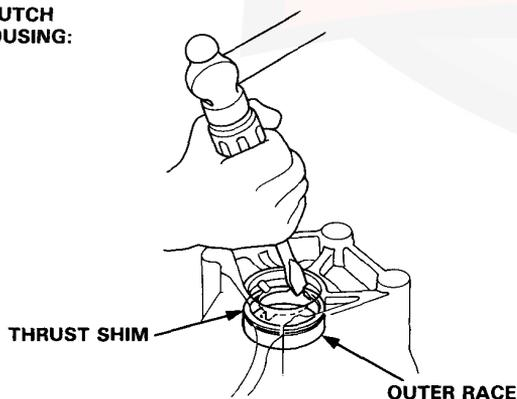

3. After installing the shim, install a outer race in the transmission housing and clutch housing.

NOTE:

- Install the outer race squarely.
- Check that there is no clearance between the outer race, shim, and transmission housing.

TRANSMISSION HOUSING:

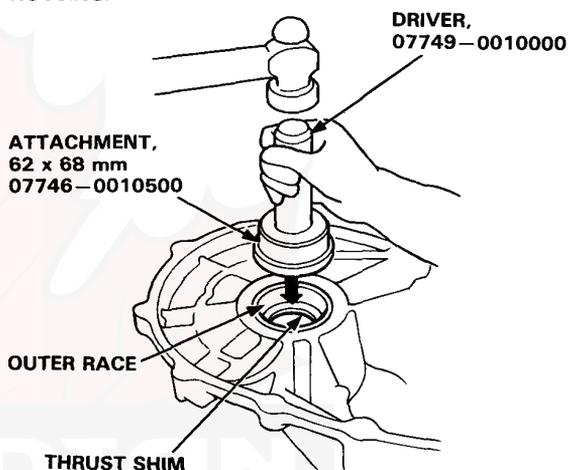

CLUTCH HOUSING:

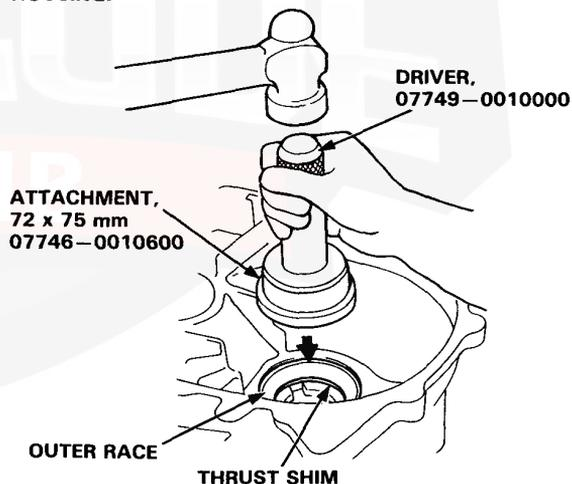

4. Install the oil seal (page 8-25).

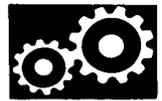

Taper Roller Bearing Preload Adjustment

NOTE: If any of the items listed below were replaced, the bearing preload must be adjusted.

- TRANSMISSION HOUSING
- CLUTCH HOUSING
- CARRIER
- TAPER ROLLER BEARING and OUTER RACE
- THRUST SHIM

1. Remove the bearing outer race and thrust shim from the transmission housing (page 8-22).

NOTE: Select the thrust shim only on the transmission housing side.

CAUTION: Do not reuse the thrust shim if the outer race was pried out.

NOTE: Let the transmission cool to the room temperature if the outer race was removed by heating the case before adjusting the bearing preload.

2. First try a 2.17 mm (0.085 in) thrust shim (standard shim).

CAUTION: Do not use more than one shim to adjust the bearing preload.

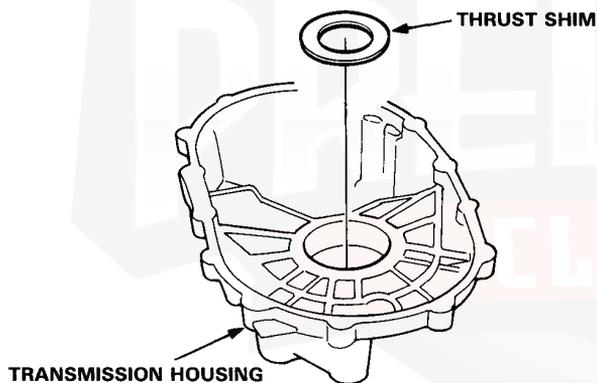

3. Select shim from the following table.

	PART NUMBER	THICKNESS
A	41381-PX5-000	1.90 mm (0.075 in)
B	41382-PX5-000	1.93 mm (0.076 in)
C	41383-PX5-000	1.96 mm (0.077 in)
D	41384-PX5-000	1.99 mm (0.078 in)
E	41385-PX5-000	2.02 mm (0.079 in)
F	41386-PX5-000	2.05 mm (0.081 in)
G	41387-PX5-000	2.08 mm (0.082 in)
H	41388-PX5-000	2.11 mm (0.083 in)
I	41389-PX5-000	2.14 mm (0.084 in)
*J	41390-PX5-000	2.17 mm (0.085 in)
K	41391-PX5-000	2.20 mm (0.087 in)
L	41392-PX5-000	2.23 mm (0.088 in)
M	41393-PX5-000	2.26 mm (0.089 in)
N	41394-PX5-000	2.29 mm (0.090 in)
O	41395-PX5-000	2.32 mm (0.091 in)
P	41396-PX5-000	2.35 mm (0.092 in)
Q	41397-PX5-000	2.38 mm (0.094 in)
R	41398-PX5-000	2.41 mm (0.095 in)
S	41399-PX5-000	2.44 mm (0.096 in)
T	41400-PX5-000	2.47 mm (0.097 in)

* Standard shim

4. After installing the shim, install the outer race in the transmission housing (page 8-22).

NOTE:

- Install the outer race squarely.
- Check that there is no clearance between the outer race, shim and transmission housing.

5. With the mainshaft and countershaft removed, install the differential assembly, and torque the clutch and transmission housing.

TORQUE: 10 x 1.25 mm: 45 N·m
(4.5 kg-m, 33 lb-ft)

8 x 1.25 mm: 28 N·m
(2.8 kg-m, 20 lb-ft)

NOTE: It is not necessary to use sealing agent between the housings.

(cont'd)

Differential

Taper Roller Bearing Preload Adjustment (cont'd)

6. Rotate the differential assembly in both directions to seat the bearing.
7. Measure the starting torque of the differential assembly with the Preload Inspection Tool and a torque wrench.

**STANDARD: 1.4–2.6 N·m
(14–26 kg-cm, 12–23 lb-in)**

NOTE:

- Measure the preload at normal room temperature.
- Measure the preload in both directions.

8. If out of spec, select the shim which will give the correct preload and repeat steps 1 thru 7.

NOTE: Changing the shim to the next size will increase or decrease preload about 3–4 kg-cm (2.60–3.47 lb-in).

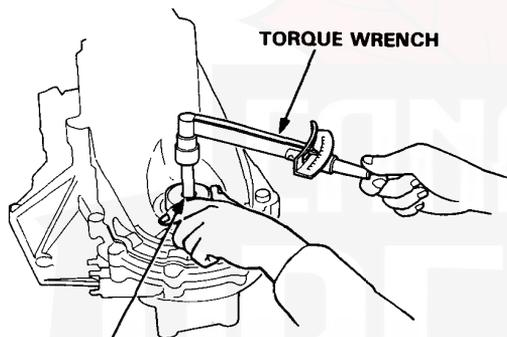

**PRELOAD INSPECTION TOOL
07HAJ-PK40201**

9. How to select the correct shim:

- 1) Compare the preload you get with the standard 2.17 mm shim, with the specified preload of 14–26 kg-cm (12–19 lb-in).
- 2) If your measured preload is less than specified, subtract your's from the specified. If your's is more than specified, subtract the specified from your measurement.

For example:

$$\begin{array}{r} \textcircled{A} \text{ specified} \quad 26 \text{ kg-cm (23 lb-in)} \\ - \text{ you measure} \quad 6 \text{ kg-cm (5 lb-in)} \\ \hline 20 \text{ kg-cm (18 lb-in) less} \end{array}$$

$$\begin{array}{r} \textcircled{B} \text{ you measure} \quad 34 \text{ kg-cm (30 lb-in)} \\ - \text{ specified} \quad 26 \text{ kg-cm (23 lb-in)} \\ \hline 8 \text{ kg-cm (7 lb-in) more} \end{array}$$

- 3) Each shim size up or down from standard makes about 3–4 kg-cm (2.60–3.47 lb-in) difference in preload.

- In example A, your measured preload was 20 kg-cm less than standard so you need a shim five sizes thicker than standard (try the 2.32 mm shim, and recheck).
- In example B, your's was 8 kg-cm more than standard, so you need a shim two sizes thinner (try the 2.11 mm shim, and recheck).

10. After adjusting the preload, assemble the transmission and install the transmission housing.

**TORQUE: 10 x 1.25 mm: 45 N·m
(4.5 kg-m, 33 lb-ft)
8 x 1.25 mm: 28 N·m
(2.8 kg-m, 20 lb-ft)**

11. Rotate the differential assembly in both directions to seat the bearings.

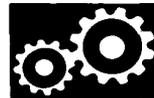

Oil Seal Installation

1. Drive the oil seal in until it's flush with the transmission housing using the special tools.

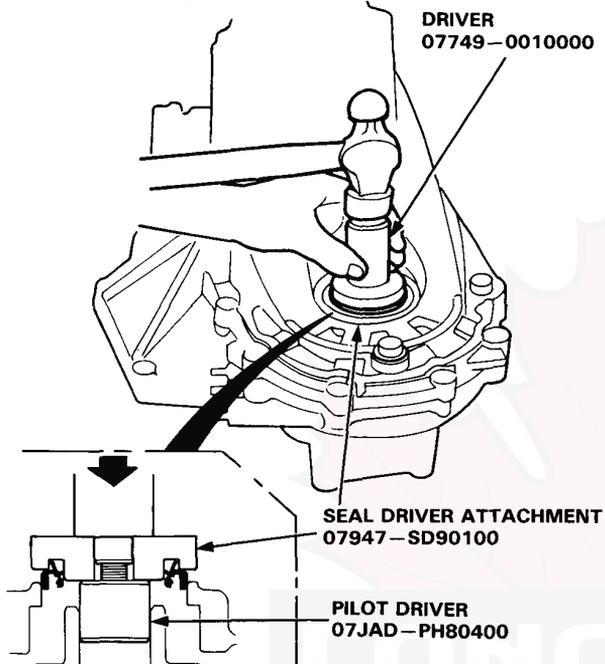

2. Install the oil seal in the clutch housing using the special tools.

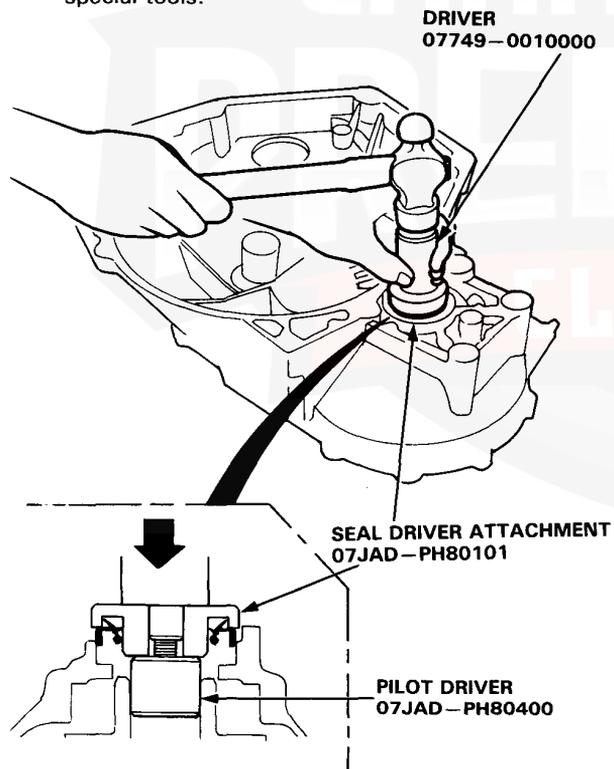

Automatic Transmission

Transmission	9-1
Differential	9-115

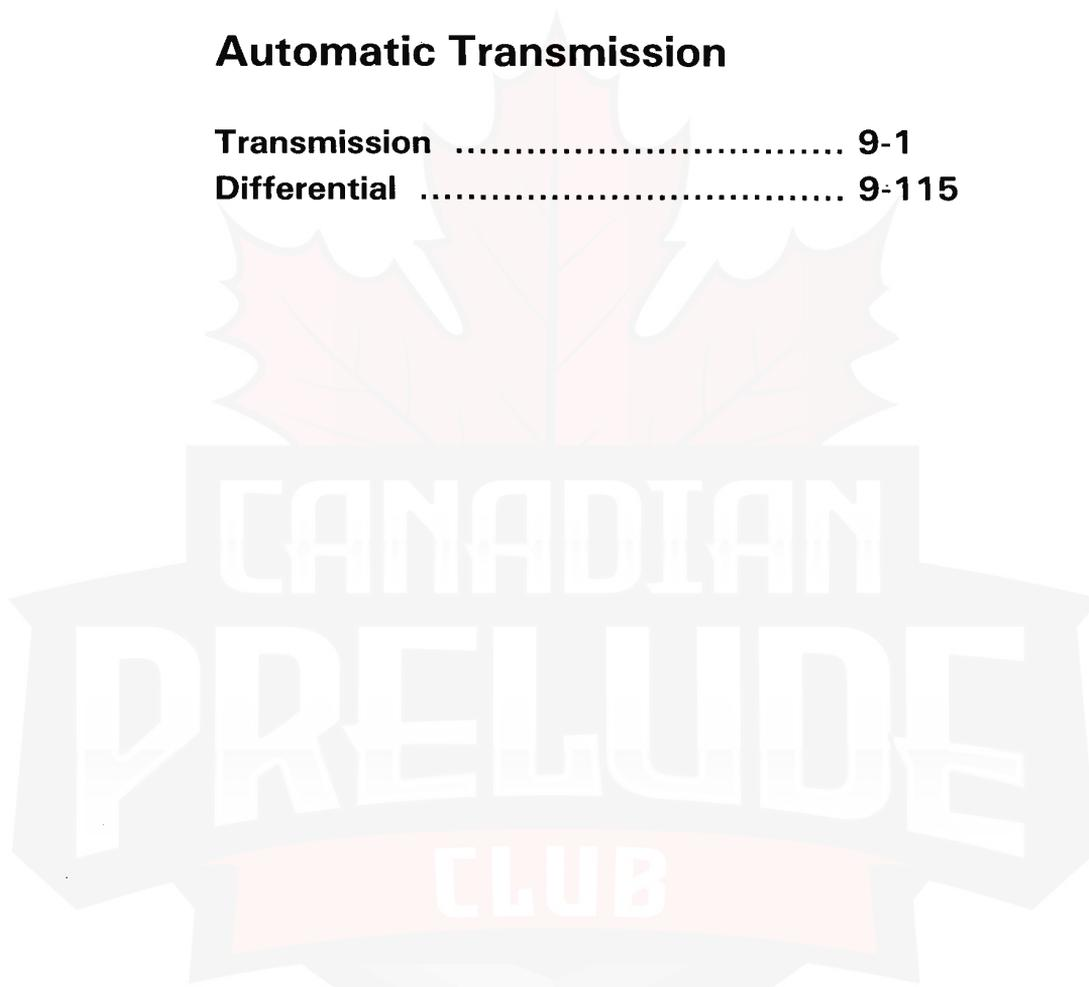

Outline of Model Changes

- The A/T control unit wiring color has been modified.
- The lock-up control solenoid valve and shift control solenoid valve have been changed.
- The on-road test values has been changed.
- The line pressure and throttle B pressure of carbureted engine have been changed.
- The valve body has been modified.
- The mainshaft thrust washer selecting has been changed.
- The 2nd clutch disc spring assembly direction has been changed.
- The gearshift selector removal/installation has been added.
- The shift indicator panel adjustment has been modified.
- The throttle control cable adjustment/inspection has been modified.
- The differential bearing replacement has been changed.

Transmission

Special Tools	9-2	Valve	
Description	9-3	Assembly	9-80
Component Location	9-20	Main Valve Body	9-81
A/T Control Unit		Regulator Valve Body	9-83
Circuit Diagram	9-24	Secondary Valve Body	9-84
Troubleshooting Procedures	9-30	Servo Valve Body	9-86
Symptom-to-Component Chart		Lock-Up Body	9-87
Electrical System	9-31	2nd Accumulator Body	9-88
Troubleshooting Flowchart	9-33	ATV Pulser Rotor	9-88
A/T Speed Pulser	9-54	1st Accumulator/R. Side Cover	9-89
Lock-up Control Solenoid		Mainshaft	9-90
Valve A/B	9-55	Countershaft	9-92
Shift Control Solenoid		Clutch	
Valve A/B	9-56	Illustrated Index	9-94
Symptom-to-Component Chart		Disassembly	9-96
Hydraulic System	9-57	Reassembly	9-98
Road Test	9-61	Transmission	
Stall Speed	9-65	Reassembly	9-102
Pressure Testing	9-66	Installation	9-108
Fluid Level	9-72	Gear Shift Selector	9-110
Transmission		Shift Cable	
Removal	9-73	Adjustment	9-111
Illustrated Index	9-76	Shift Indicator Panel	9-112
Transmission Housing/Valve Body		Throttle Control Cable	9-113
Removal	9-78		

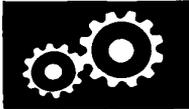

Special Tools

Special Tools

Ref. No.	Tool Number	Description	Qty	Remarks
①	07GAB—PF50100	Mainshaft Holder	1	
②	07GAE—PG40001	Clutch Spring Compressor Set	1	
②-1	07HAE—PL50100 or 07LAE—PX40100	Clutch Spring Compressor Attachment	1	
②-2	07GAE—PG40200	Clutch Spring Compressor Bolt Assembly	1	
②-3	07960—6120100 or 07960—6120101	Clutch Spring Compressor Attachment	1	
③	07GMJ—ML80100	Test Harness	1	
④	07HAC—PK40100 or 07HAC—PK4010A or 07GAC—PG40102	Housing Puller	1	
⑤	07406—0020003	A/T Oil Pressure Gauge Set	1	
⑤-1	07406—0020201	A/T Oil Pressure Gauge Replacement Hose		

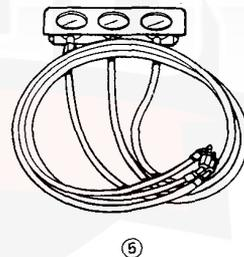
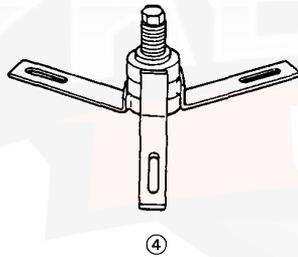
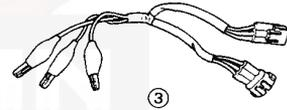
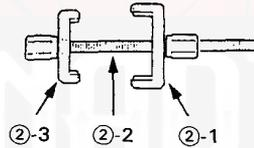
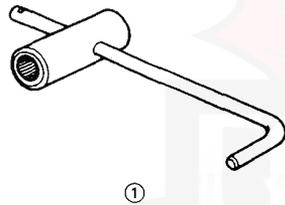

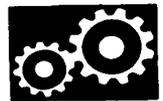

Description

A/T Control Unit

- From various input signals, the A/T control unit controls the shift control solenoid valves A and B and the lock-up control solenoid valves A and B.
- The A/T control unit is below the dash under the carpet on the passenger's side of the car.
- The A/T control unit has a self-diagnosis function that indicates the area of trouble with the number of blinks of the self-diagnosis indicator (LED).

Circuit Diagram for PGM-FI model

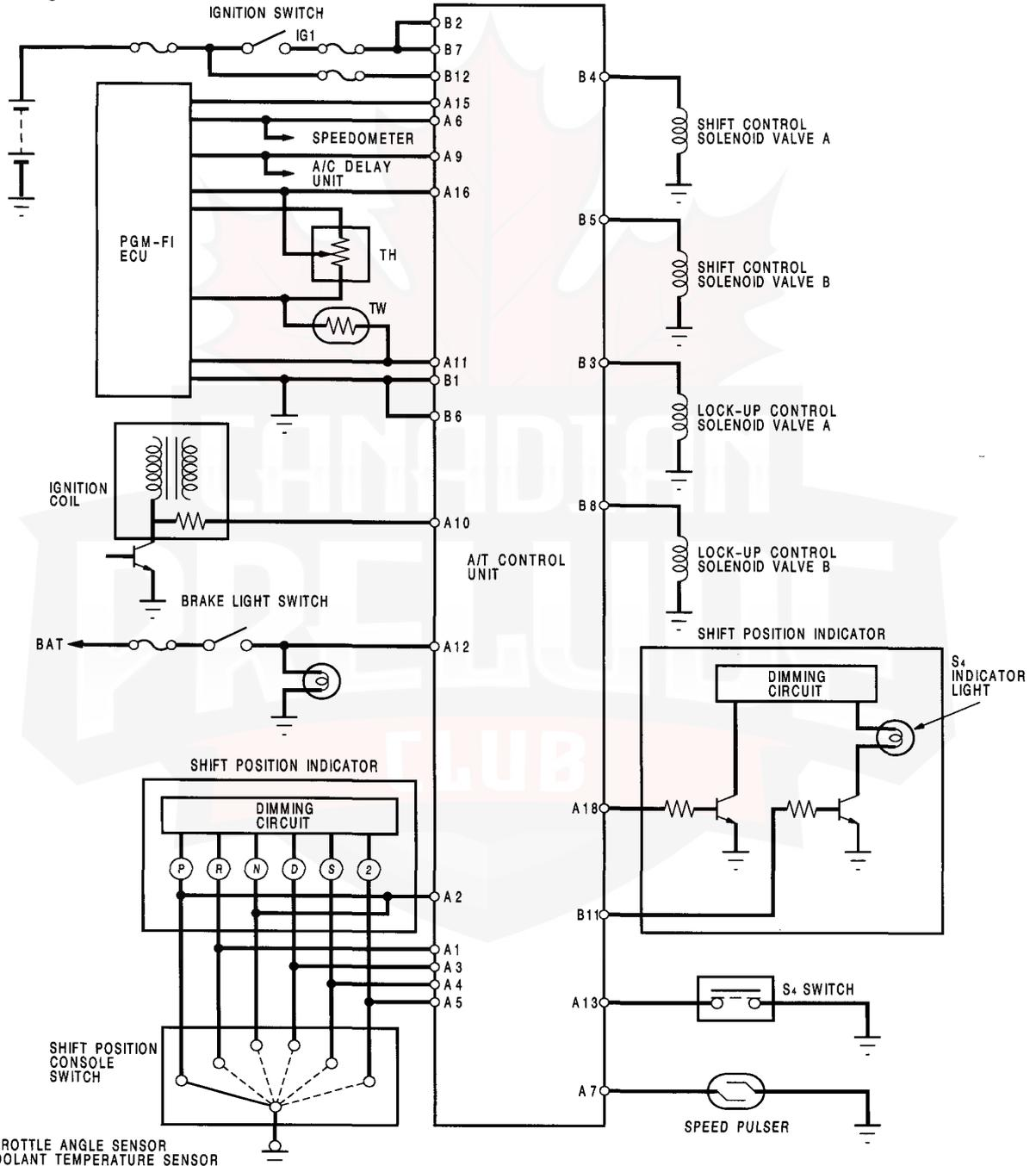

Description

Hydraulic Flow

Generation of Hydraulic Pressure



Distribution of Hydraulic Pressure

- Manual Valve → to select Line Pressure
- Throttle Valve B → Throttle B Pressure
- 1-2 Shift Valve → Clutch Pressure
- 2-3 Shift Valve → Clutch Pressure
- 3-4 Shift Valve → Clutch Pressure
- Line Pressure → Servo Valve
- Line Pressure → Throttle Valve

No.	DESCRIPTION OF PRESSURE	PATTERN
1	LINE	■
2	LINE	■
3	LINE	■
3'	LINE	■
3''	LINE	■
4	LINE	■
4'	LINE	■
4''	LINE	■
4'''	LINE	■
5	LINE	■
6	MODULATE	▨
10	1ST CLUTCH	■
11	1ST CLUTCH	■
20	2ND CLUTCH	■
25	2ND CLUTCH	■

No.	DESCRIPTION OF PRESSURE	PATTERN
30	3RD CLUTCH	■
31	3RD CLUTCH	■
40	4TH CLUTCH	■
41	4TH CLUTCH	■
55	THROTTLE B	▨
56	THROTTLE B	▨
90	TORQUE CONVERTER	▧
91	TORQUE CONVERTER	▧
92	TORQUE CONVERTER	▧
93	OIL COOLER	▧
94	TORQUE CONVERTER	▧
95	LUBRICATION	▧
96	TORQUE CONVERTER	▧
99	SUCTION	■
x	LEAK	■



N Position

As the engine turns, the oil pump also starts to operate. Automatic Transmission Fluid (ATF) is drawn from (99) and discharged into (1). Then, AFT pressure is controlled by the regulator valve and becomes the line pressure (1). The torque converter inlet pressure (92) enters (94) of torque converter through the orifice and discharges into (90). The torque converter check valve prevents the torque converter pressure from falling. Under this condition, the hydraulic pressure is not applied to the clutches as the manual valve stops line pressure (1).

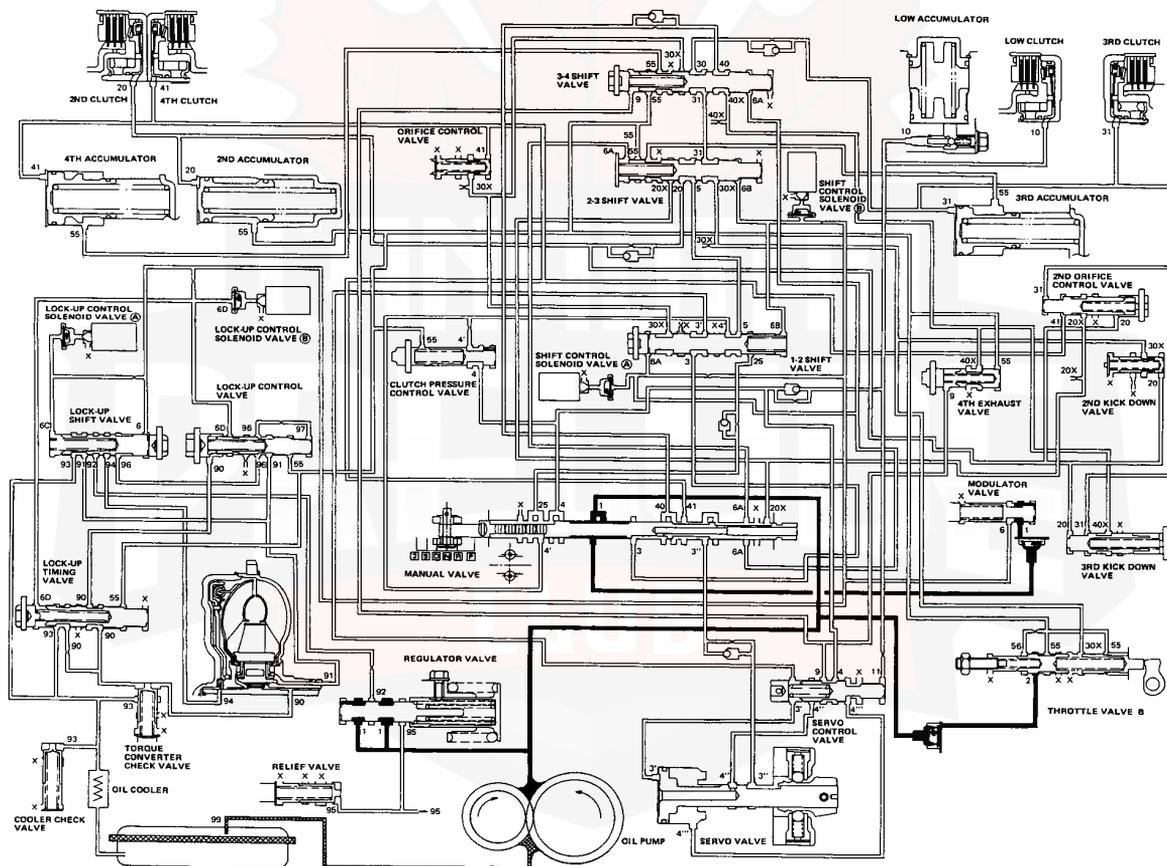

(cont'd)

Description

Hydraulic Flow (cont'd)

2 Position

The line pressure (1) becomes the 2nd clutch pressure (25) as it passes through the manual valve. The 2nd clutch pressure (25) changes at the 1-2 shift valve to the line pressure (5), it changes to the 2nd clutch pressure (20) at the 2-3 shift valve. And then it goes to the 2nd clutch. Also, the line pressure (1) goes to the modulator valve through the filter and becomes the modulator pressure (6). The modulator pressure (6) is supplied to the 1-2, 2-3 and 3-4 shift valves. The line pressure (2) also flows to the throttle valve B.

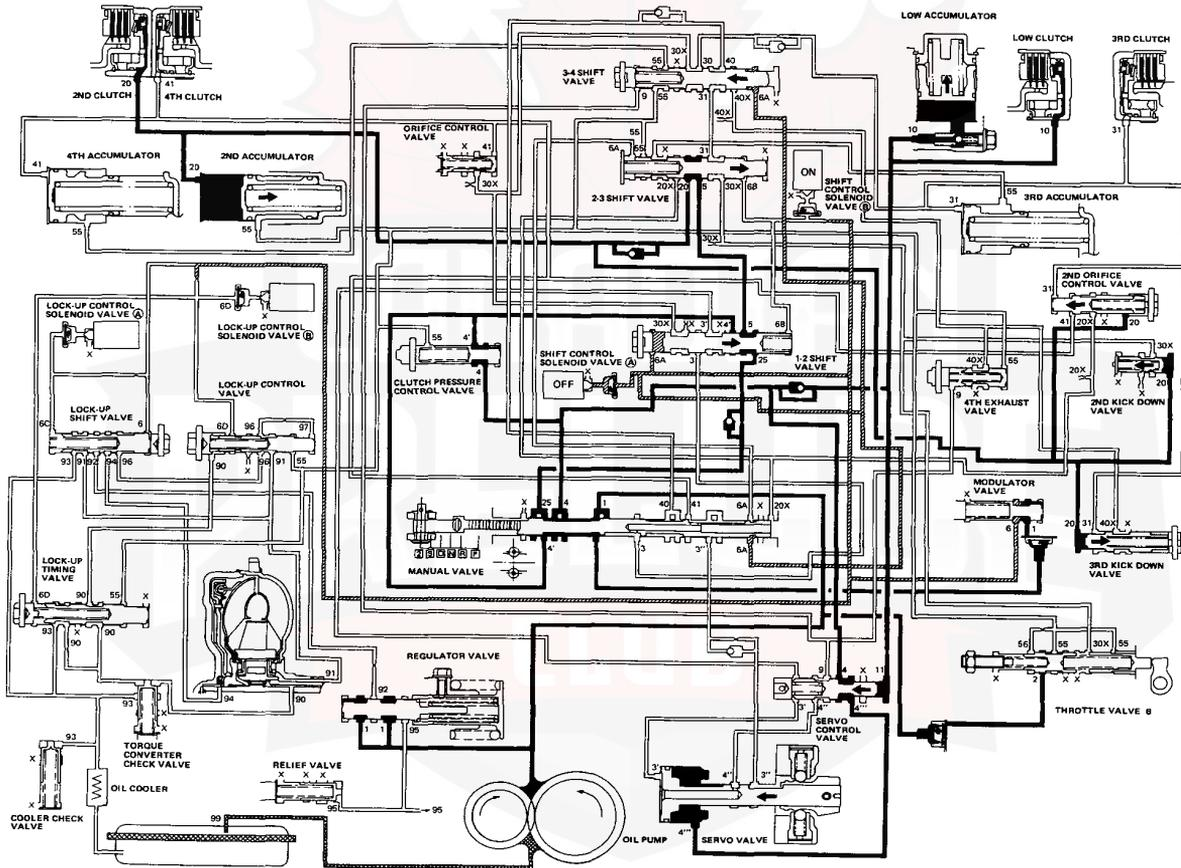

Description

Hydraulic Flow (cont'd)

2. 2nd Speed

The flow of fluid up to the 1-2 and 2-3 shift valves is the same as in the 1st speed. When the vehicle speed is increased and reaches the prescribed value, the solenoid valve A is turned on by means of the control unit. As a result, the 1-2 shift valve is moved to the left and uncovers the port leading to the 2nd clutch; the 2nd clutch is engaged.

The fluid flows by way of:

Line Pressure (1) → Manual Valve-Line Pressure (4) → Clutch Pressure Control Valve → 1-2 Shift Valve-Line Pressure (5) → 2-3 Shift Valve-2nd Clutch Pressure → 2nd Clutch

The hydraulic pressure also flows to the 1st clutch. However no power will transmit by means of the one-way clutch.

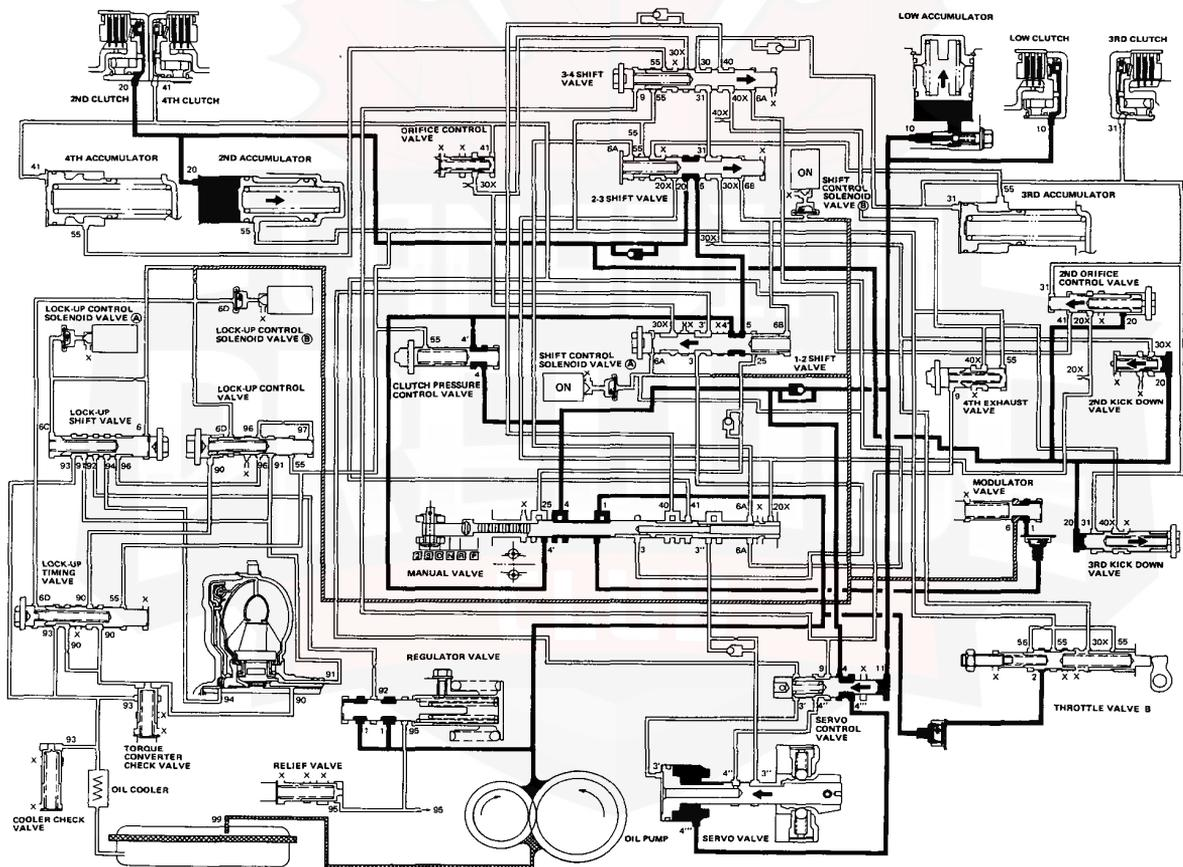

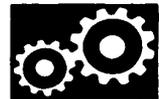

3. 3rd Speed

The flow of fluid up to the 1-2, 2-3 and 3-4 shift valves is the same as in the 2nd speed. As the speed of the car reaches the prescribed value, the shift control solenoid valve B is turned off (shift control valve A remains on). The 2-3 shift valve is then moved to the left, uncovering the oil port leading to the 3rd clutch. Since the 3-4 shift valve is moved to the right to cover the oil port to the 4th clutch, the 3rd clutch is turned on.

Fluid flows by way of:

Line Pressure (1) → Manual Valve-Line Pressure (4) → Clutch Pressure Control Valve → 1-2 Shift Valve-Line Pressure (5) → 2-3 Shift Valve-3rd Clutch Pressure (31) → 3-4 Shift Valve-3rd Clutch Pressure (30) → 3rd Clutch

The hydraulic pressure also flows to the 1st clutch. However no power will transmit by means of the one-way clutch as in the 2nd speed.

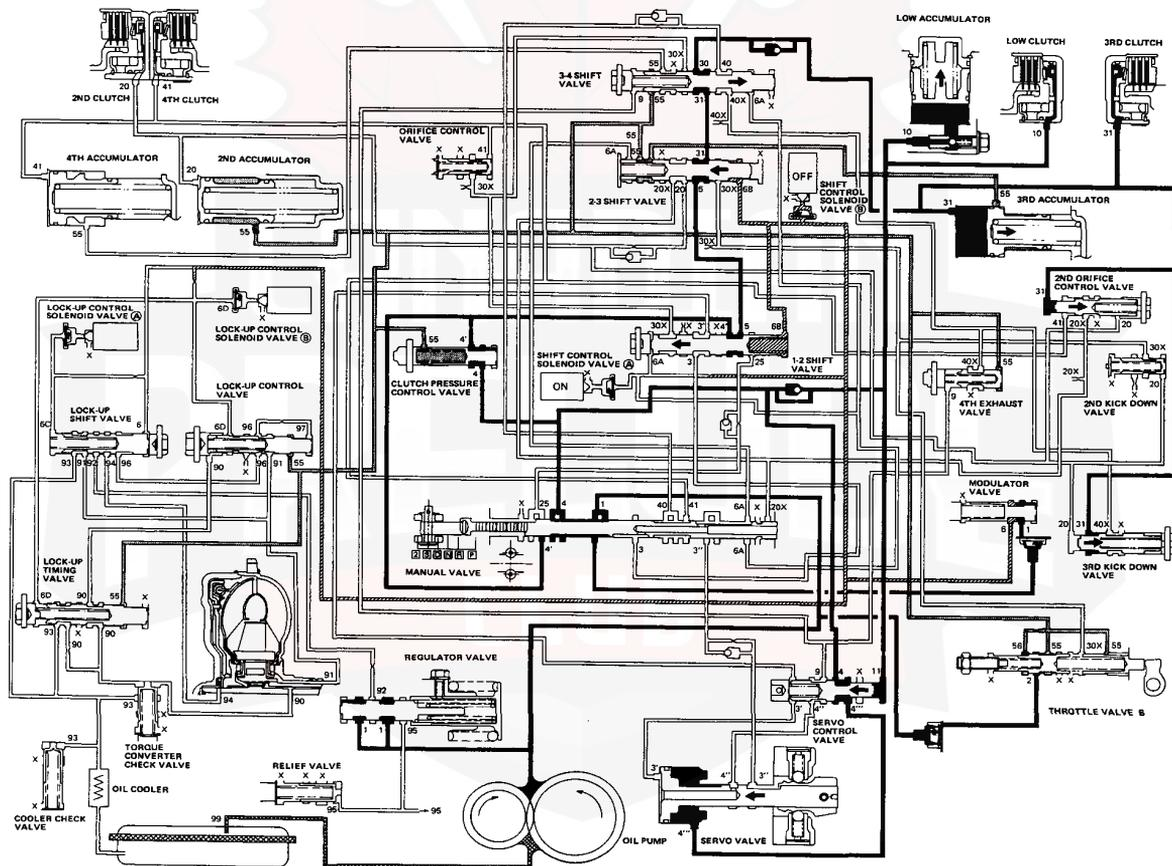

(cont'd)

Description

Hydraulic Flow (cont'd)

4. 4th Speed

The flow of fluid up to the 1-2, 2-3 and 3-4 shift valves is the same as in the 3rd speed. When the speed of the car reaches the prescribed value, the shift control solenoid valve A is turned off (shift control solenoid valve B remains off). As this takes place, 3-4 shift valve is moved to the left and uncovers the oil port leading to the 4th clutch. Since the 1-2 and 2-3 shift valves are kept on the left side, the fluid flows through the 4th clutch; the power is transmitted through the 4th clutch.

Fluid flows by ways of:

Line Pressure (1) → Manual Valve-Line Pressure (4) → Clutch Pressure Control Valve → 1-2 Shift Valve-Line Pressure (5) → 2-3 Shift Valve-3rd Clutch Pressure (31) → 3-4 Shift Valve-4th Clutch Pressure (40) → Manual Valve-4th Clutch Pressure (40) → 4th Clutch

The hydraulic pressure also flows to the 1st clutch. However no power will transmit by means of the one-way clutch as in 2nd and 3rd speed.

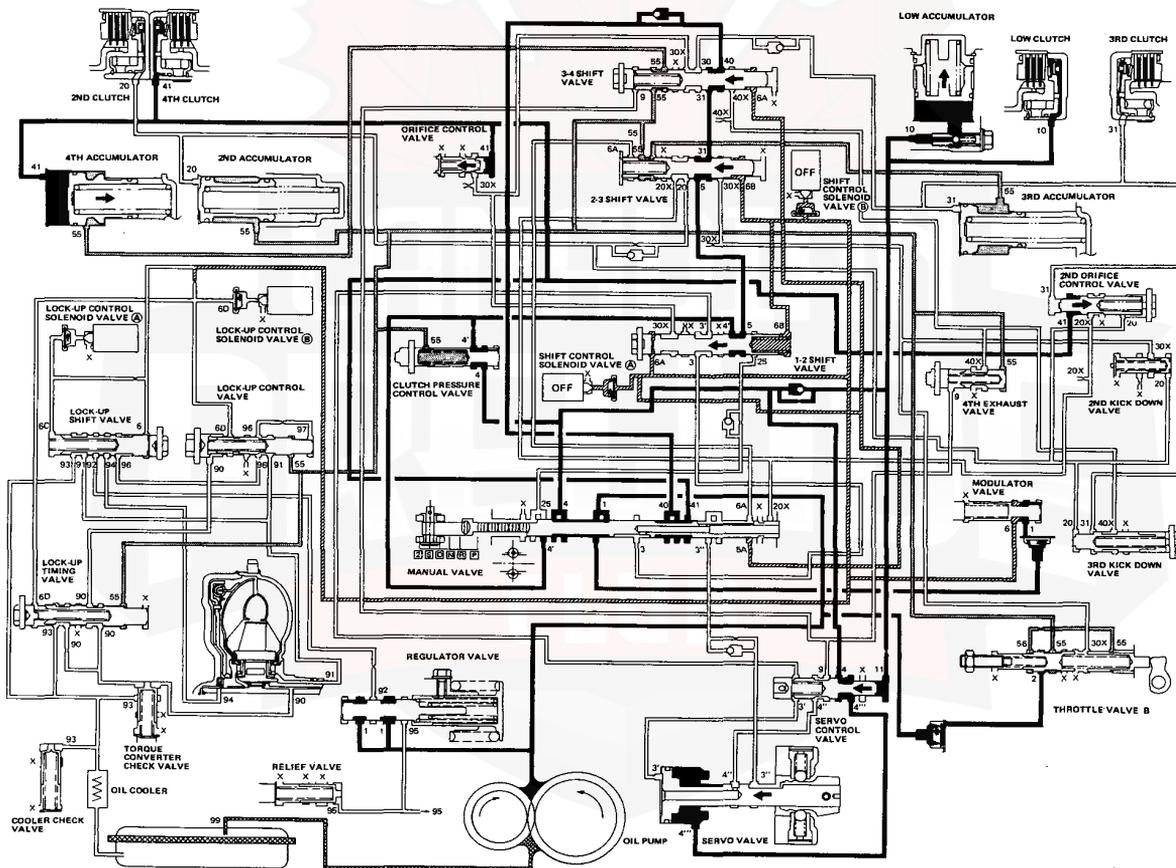

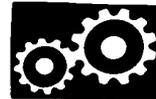

R Position

The flow of fluid through the torque converter circuit is the same as in the **N**. The fluid (1) from the oil pump flows through the manual valve and becomes the line pressure (3). It then flows through the 1-2 shift valve and servo control valve to the servo valve (3), causing the shift fork shaft to be moved in the reverse direction. Under this condition, the shift control solenoid valve on whereas the valve B is turned off as in 3rd. As a result, the 1-2 Shift valve is also moved to the left. The Fluid (3'') will flow through the servo valve and manual valve to the 4th clutch; power is transmitted through the 4th clutch.

Reverse Inhibitor Control

When the **R** position is selected while the vehicle is moving forward at a speed over 10 km/h, the control unit outputs 1st signal (A: OFF, B: ON), the 1-2 shift valve is moved to the right. The line pressure (3) is intercepted by the 1-2 shift valve, consequently the power is not transmitted as the 4th clutch and servo valve are not operated.

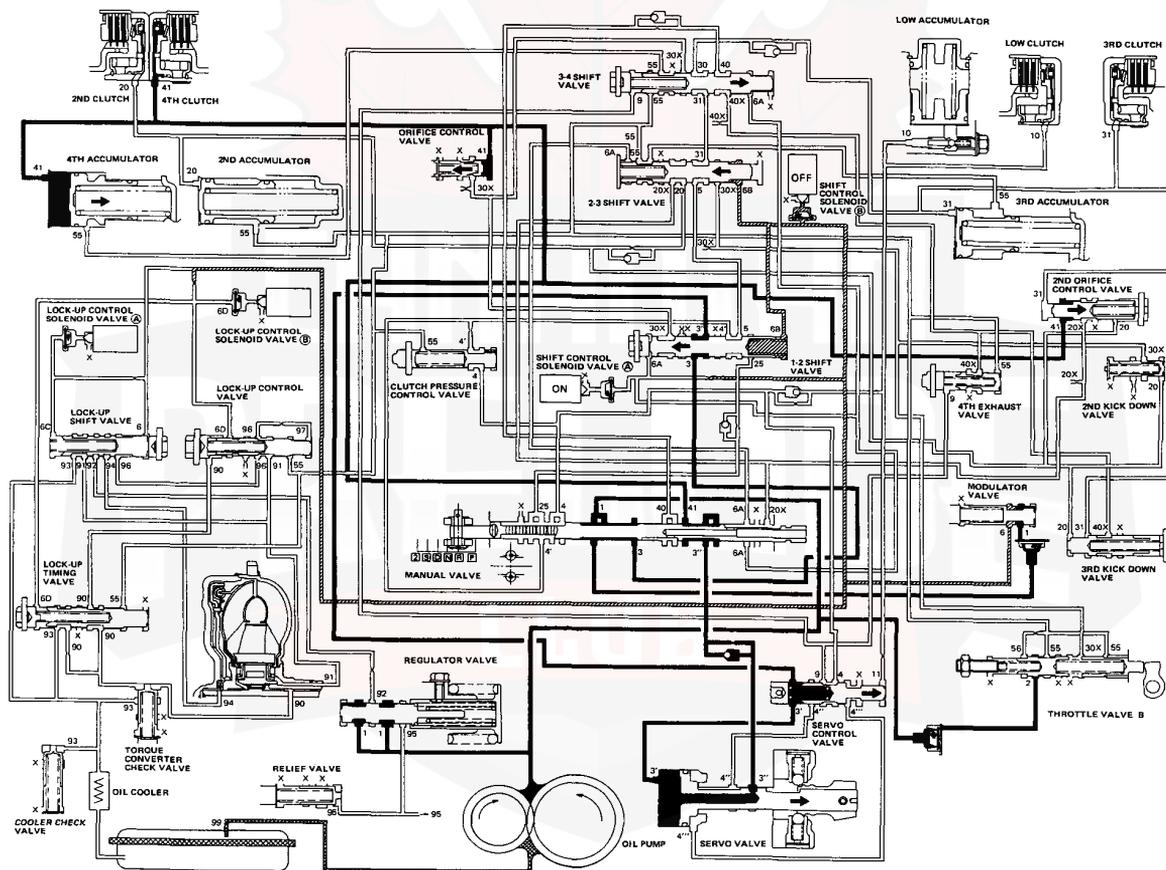

(cont'd)

Description

Hydraulic Flow (cont'd)

P Position

The flow of fluid through the torque converter is the same in **N** position.

The line pressure (1) is intercepted by the manual valve, and is not supplied to the clutches. The power is not transmitted.

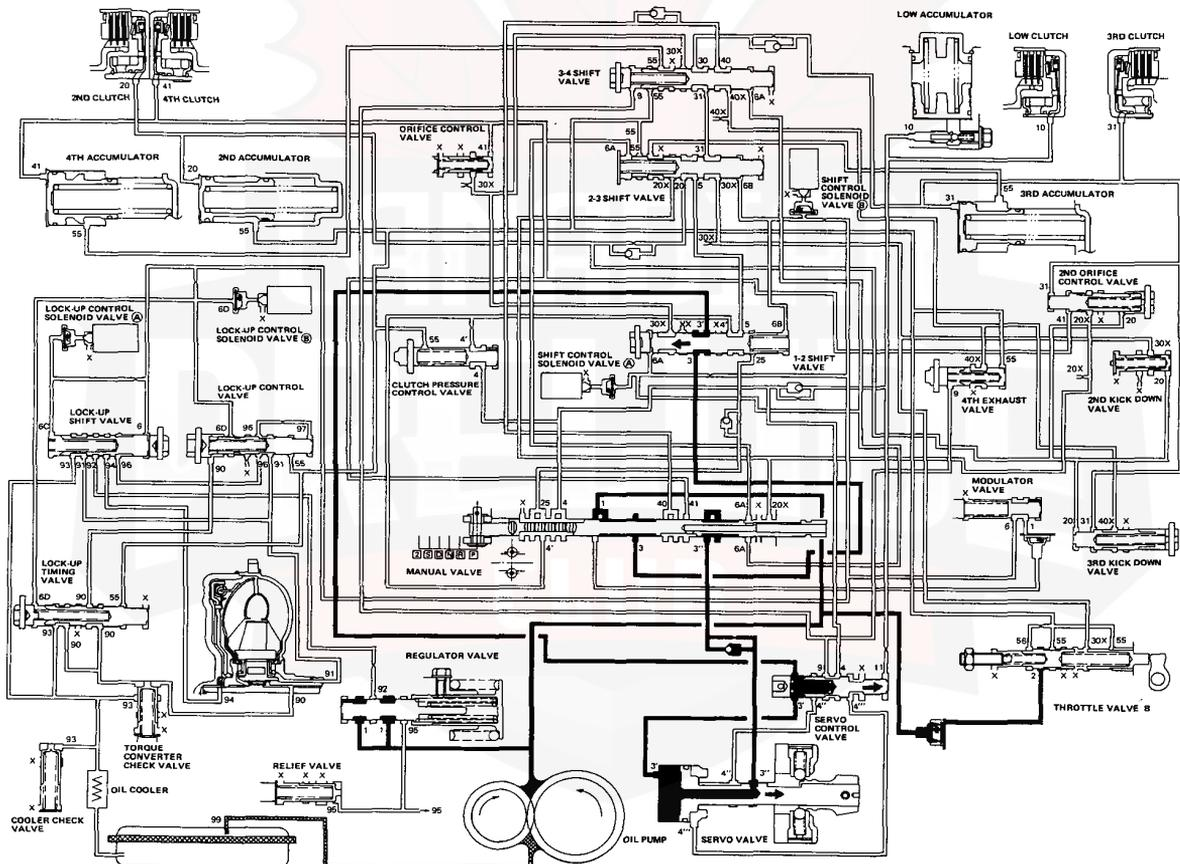



Lock-Up System

In **S4** or **D**, in 2nd, 3rd and 4th, pressurized fluid is drained from the back of the torque converter through an oil passage, causing the lock-up piston to be held against the torque converter cover. As this takes place, the mainshaft rotates at the same speed as the engine crankshaft. Together with hydraulic control, an electronic control unit optimizes the timing of the lock-up system. Under certain condition, the lock-up operation is applied during the deceleration, in 3rd and 4th speed.

The lock-up shift valve body controls the range of lock-up according to lock-up control solenoid valves A and B, and throttle valve B. When lock-up control solenoid valves A and B activate, modulator pressure changes. Lock-up control solenoid valves A and B are mounted on the torque converter housing, and are controlled by the A/T control unit.

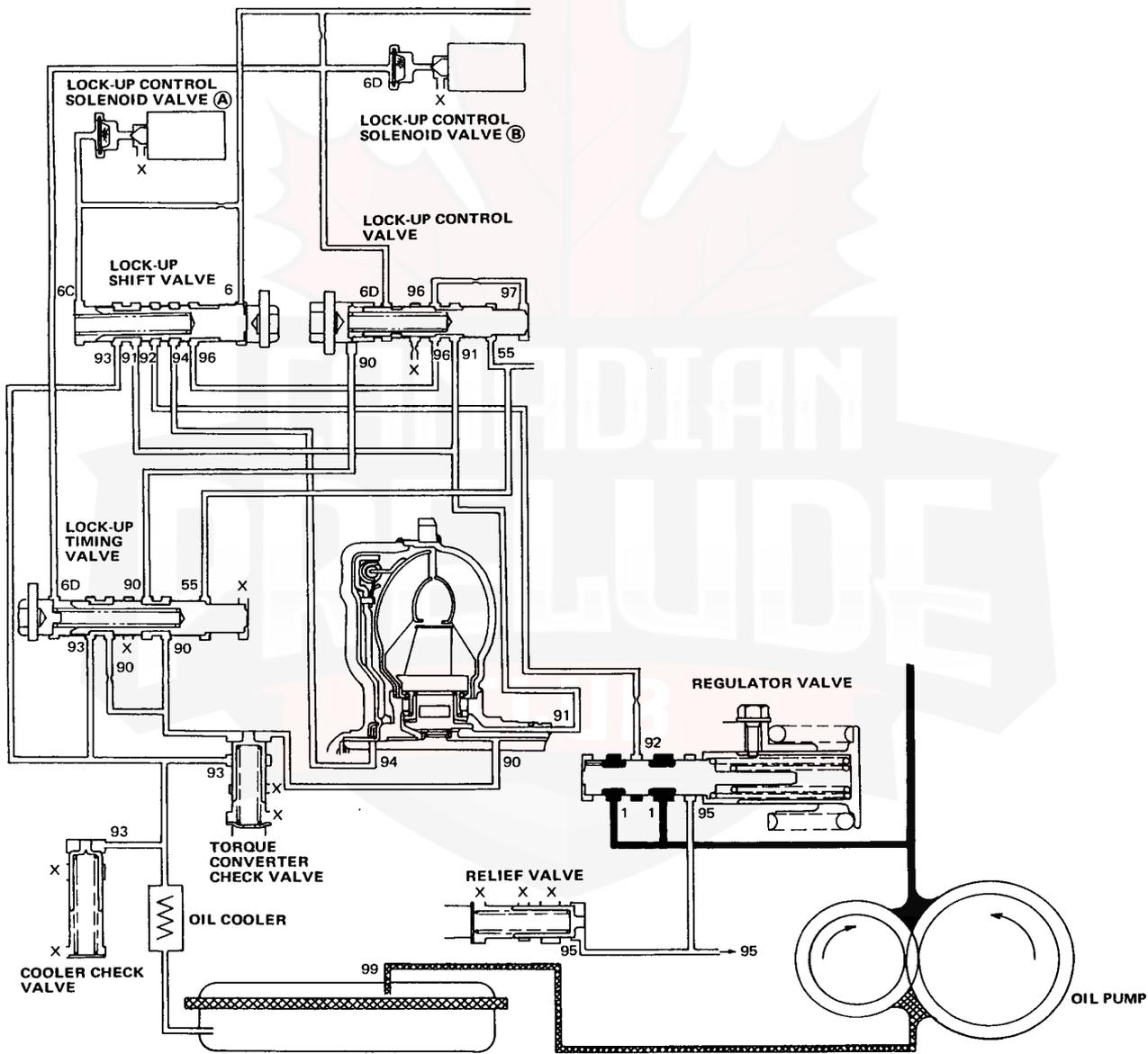

(cont'd)

Description

Lock-Up System (cont'd)

No Lock-Up

The pressurized fluid regulated by the modulator works on both ends of the lock-up shift valve and on the left side of the lock-up control valve. Under this condition, the pressures working on both ends of the lock-up shift valve are equal, the shift valve is moved to the right by the tension of the valve spring alone. The fluid from the oil pump will flow through the left side of the lock-up clutch to the torque converter; i.e., the lock-up clutch is in OFF condition.

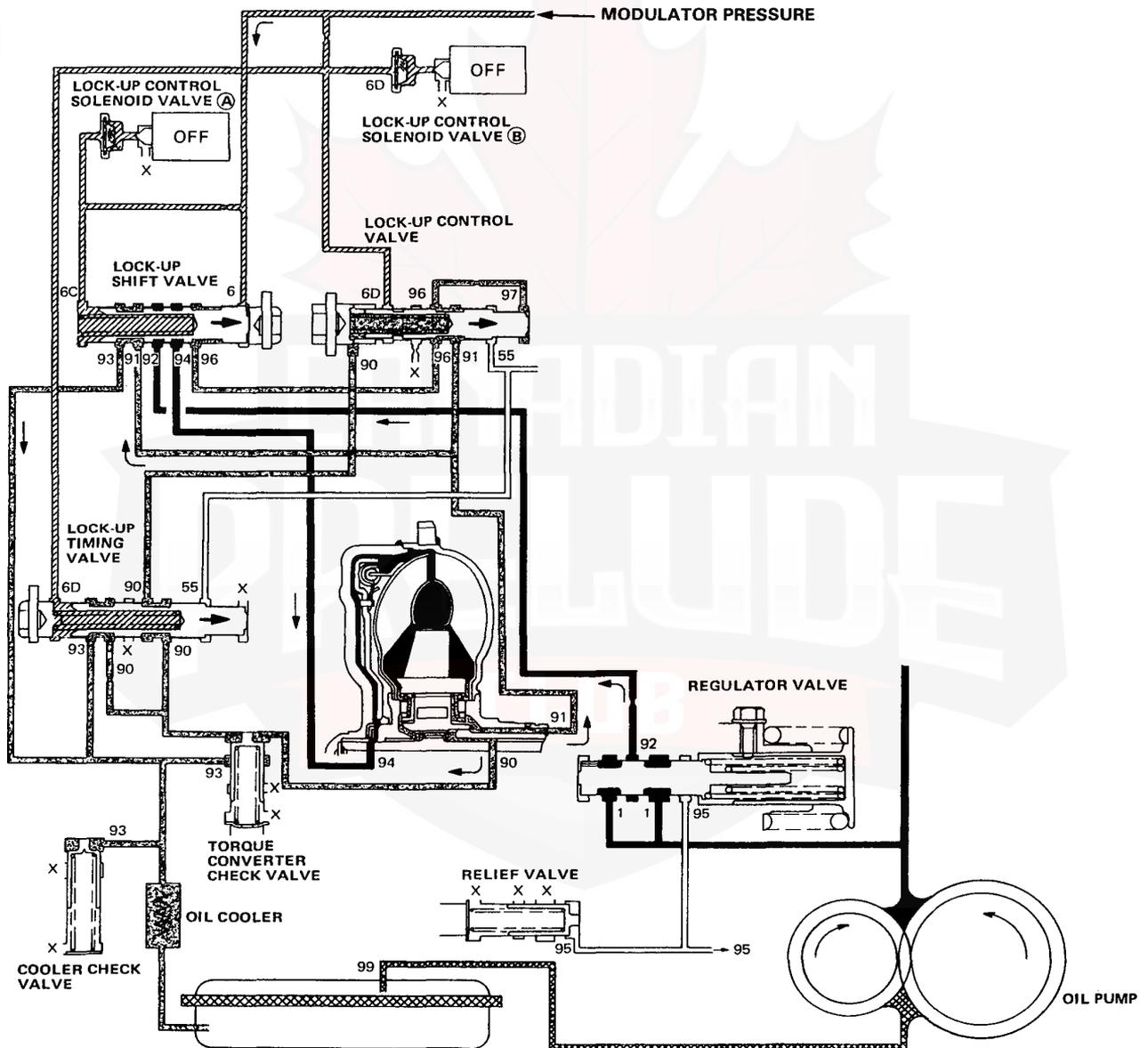

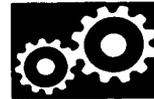

Slight Lock-Up

Lock-UP Control Solenoid Valve A: ON Lock-Up Control Solenoid Valve B: OFF

The control unit switches the solenoid valve A to on to release the modulator pressure in the left cavity of the lock-up shift valve. The modulator pressure in the right cavity of the lock-up shift valve overcomes the spring force, thus the lock-up shift valve is moved to the left side.

The torque converter pressure is separated to the two passages:

Torque Converter Inner Pressure (F1): entered into right side—to engage lock-up clutch

Torque Converter Back Pressure (F2): entered into left side—to disengage lock-up clutch

The back pressure (F2) is regulated by the lock-up control valve whereas the position of the lock-up timing valve is determined by the throttle B pressure, tension of the valve spring and pressure regulated by the modulator. Also the position of the lock-up control valve is determined by the throttle valve B pressure, back pressure of the lock-up control valve and torque converter pressure regulated by the check valve. In low speed range, the throttle B pressure working on the right side of the lock-up control valve is low, causing the valve to be moved to the right. With the lock-up control solenoid valve B kept off, the modulator pressure is maintained in the left end of the lock-up control valve; in other words, the lock-up control valve is moved slightly to the left side. This slight movement of the lock-up control valve causes the back pressure to be lowered slightly, resulting in slight lock-up.

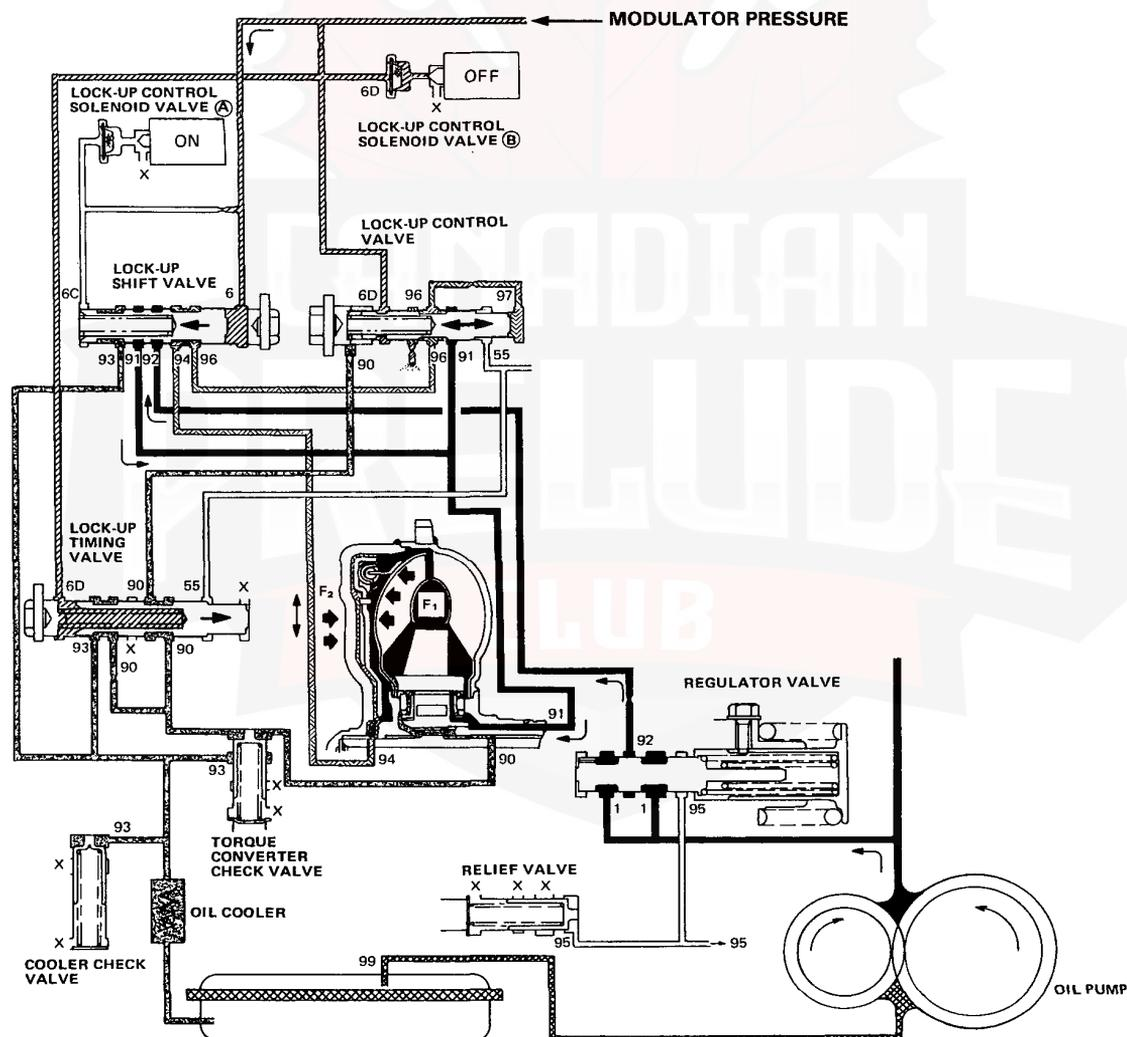

(cont'd)

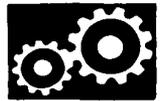

Full Lock-Up

Lock-Up Control Solenoid Valve A: ON Lock-Up Control Solenoid Valve B: ON

When the vehicle speed further increases, the throttle valve B pressure is increased in accordance with the throttle opening.

The lock-up timing valve overcomes the spring force and moves to the right side. Also this valve closes the oil port leading to the torque converter check valve.

Under this condition, the throttle B pressure working on the right end of the lock-up control valve becomes greater than that on the left end (modulator pressure in the left end has already been released by the solenoid valve B); i.e., the lock-up control valve is moved to the left. As this happens, the torque converter back pressure is released fully, causing the lock-up clutch to be engaged fully.

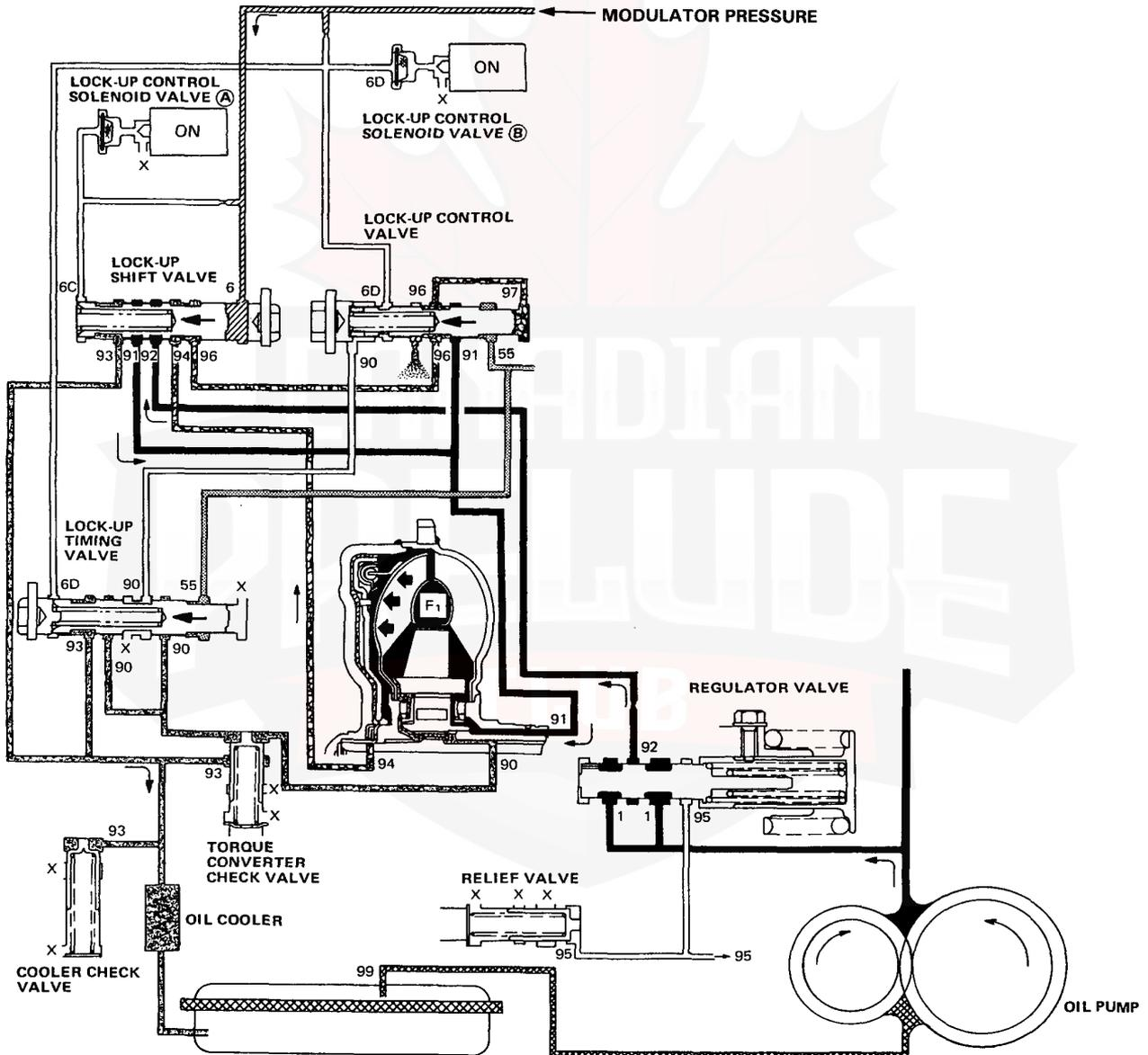

(cont'd)

Description

Lock-Up System (cont'd)

Deceleration Lock-Up

Lock-Up Control Solenoid Valve A: ON Lock-Up Control Solenoid Valve B: Duty Operation (ON ↔ OFF)

The A/T control unit switches the solenoid valve B to on and off alternately in high speed under certain condition. The slight lock-up and half lock-up regions are maintained so as to lock the torque converter properly.

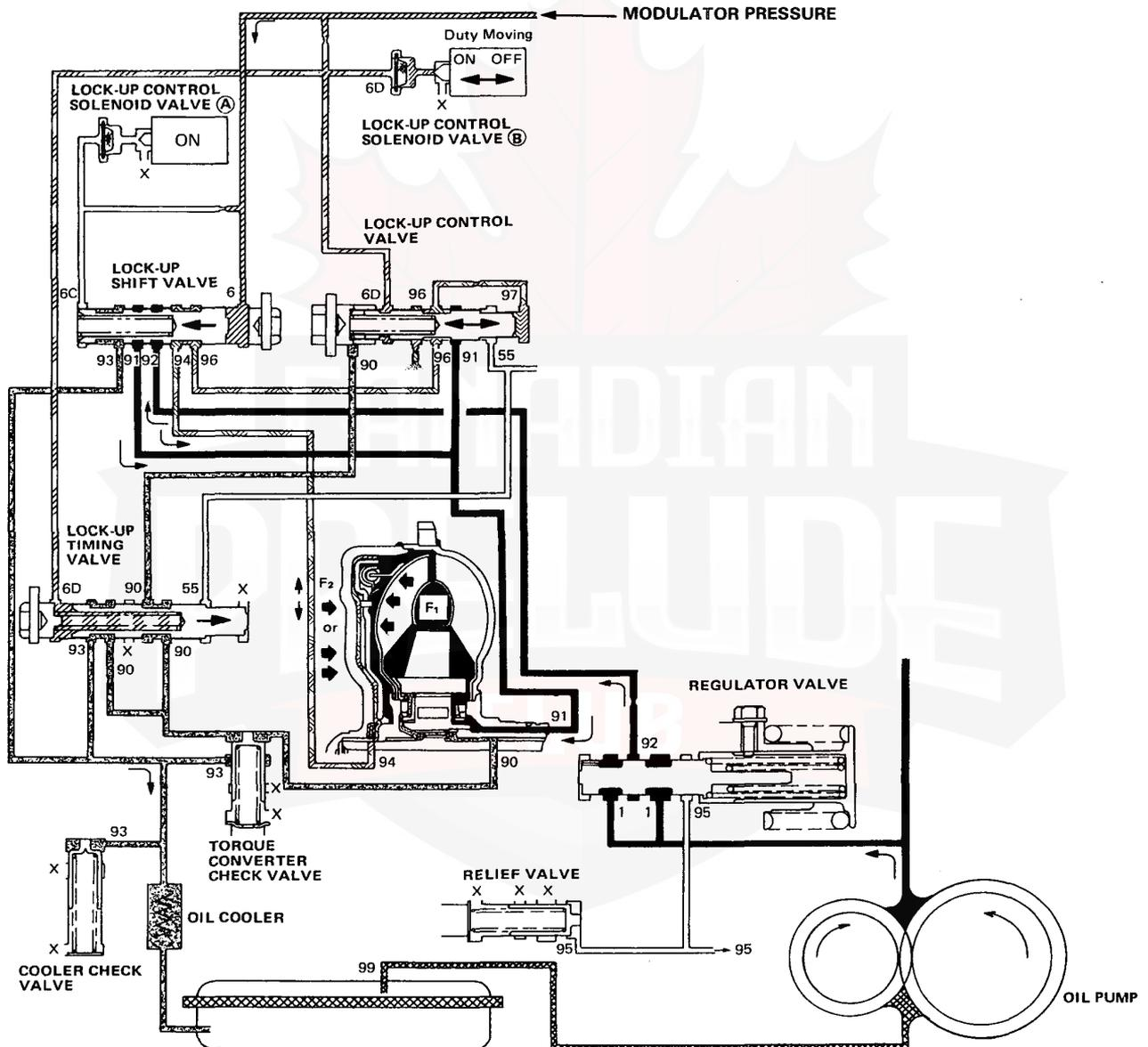

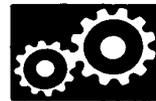

Hydraulic Control

In the hydraulic control unit, the regulator valve, manual valve and oil pump connected to the torque converter are unified and contained inside the valve body. The valve body includes the main valve body, the regulator valve body, the secondary valve body, the servo body, and the lock-up timing valve body.

The oil pump is driven by splines on the right end of the torque converter which is attached to the engine. Oil flows through the regulator valve, to maintain specified pressure through the main valve body to the manual valve, and servo body, directing pressure to each of the clutches.

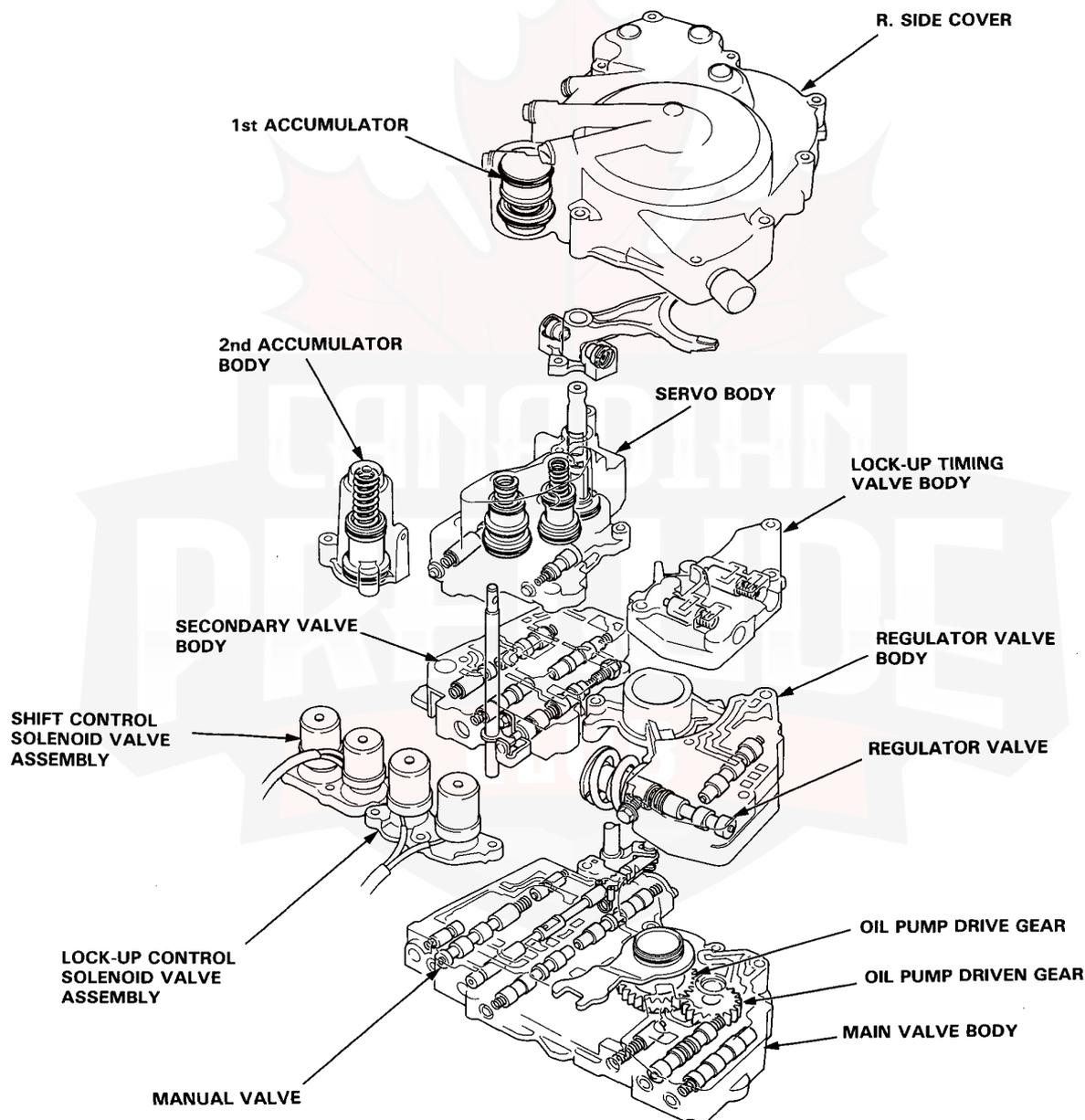

Component Locations

Carbureted engine:

LHD:

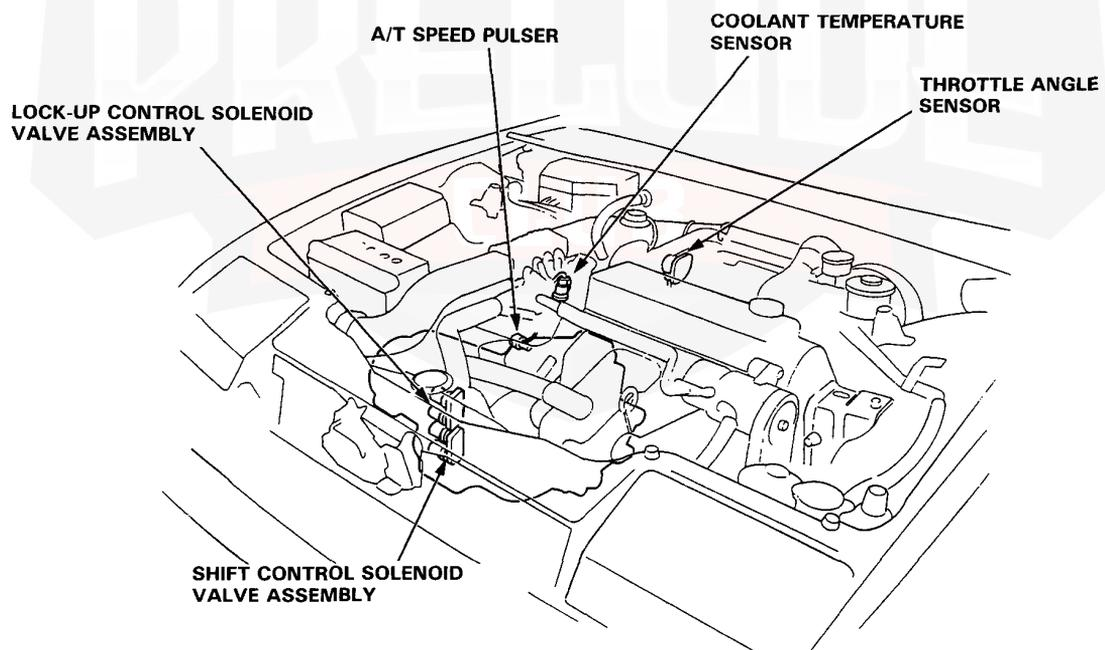
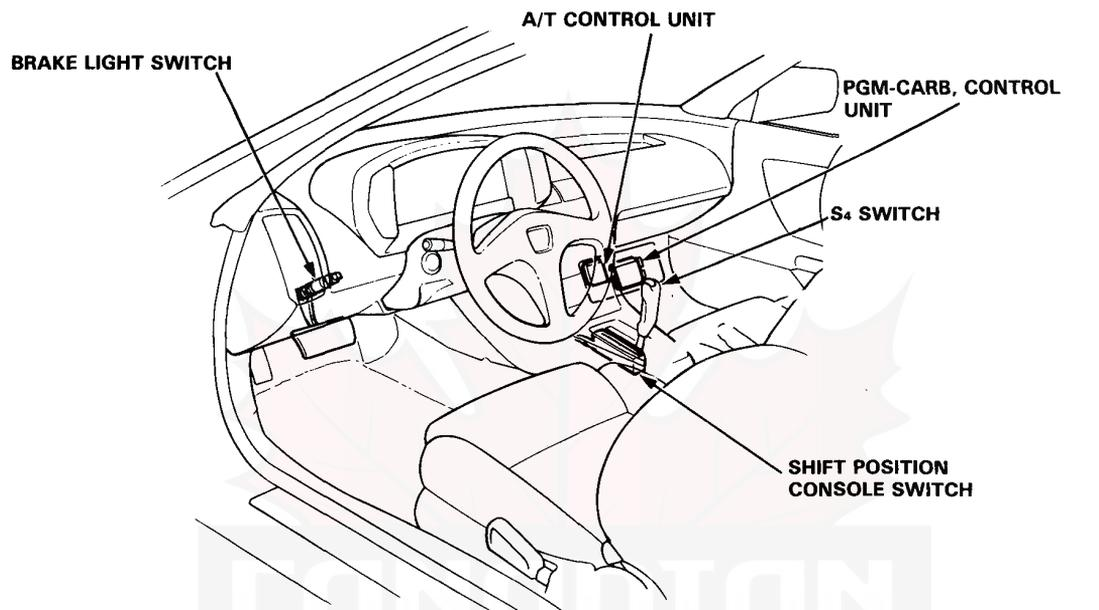

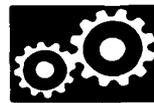

RHD:

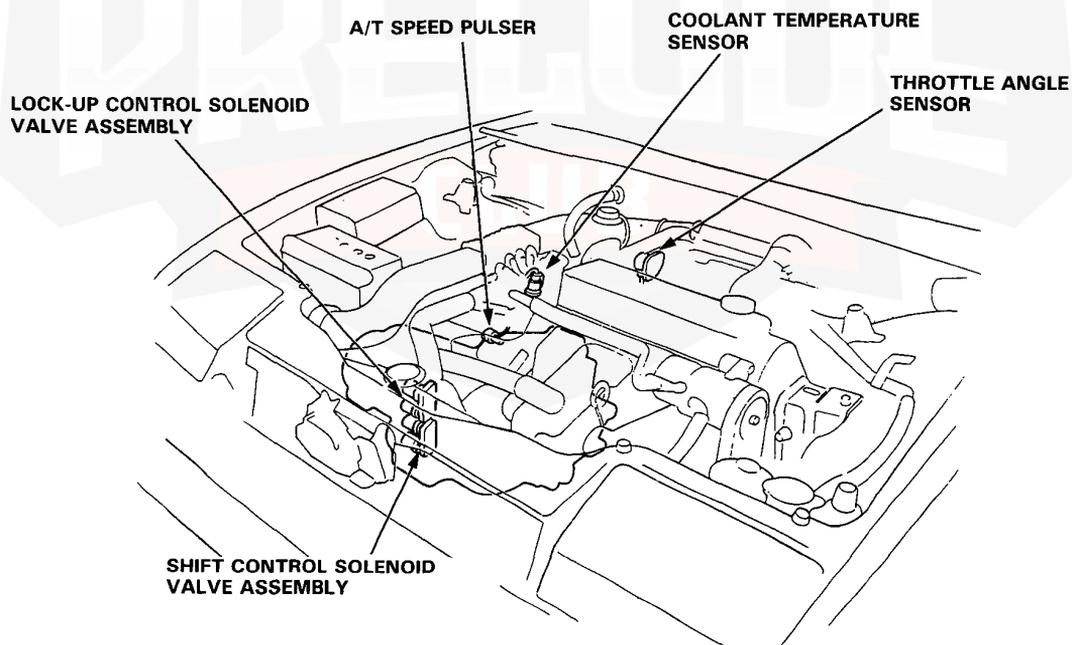
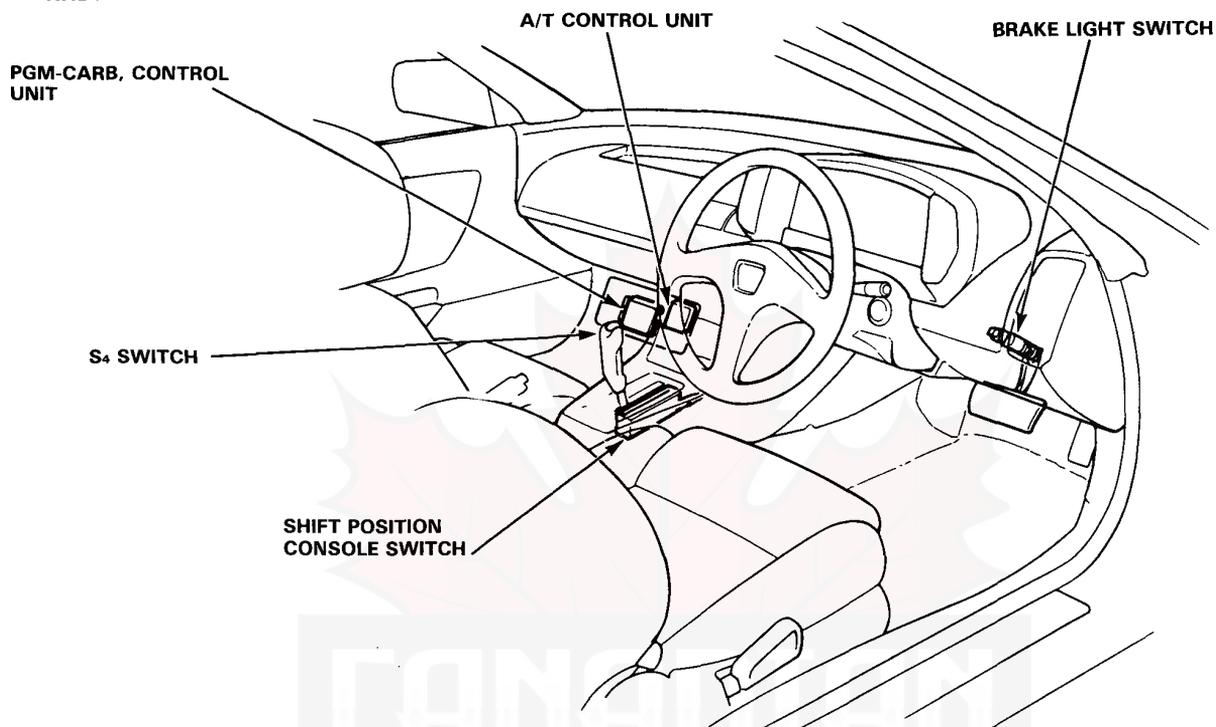

Component Locations

Fuel-Injected engine:

LHD:

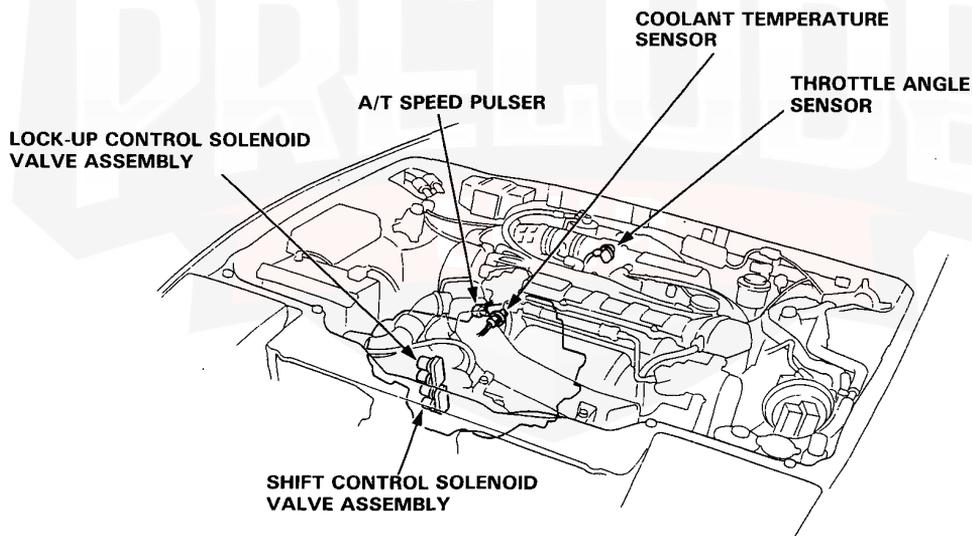
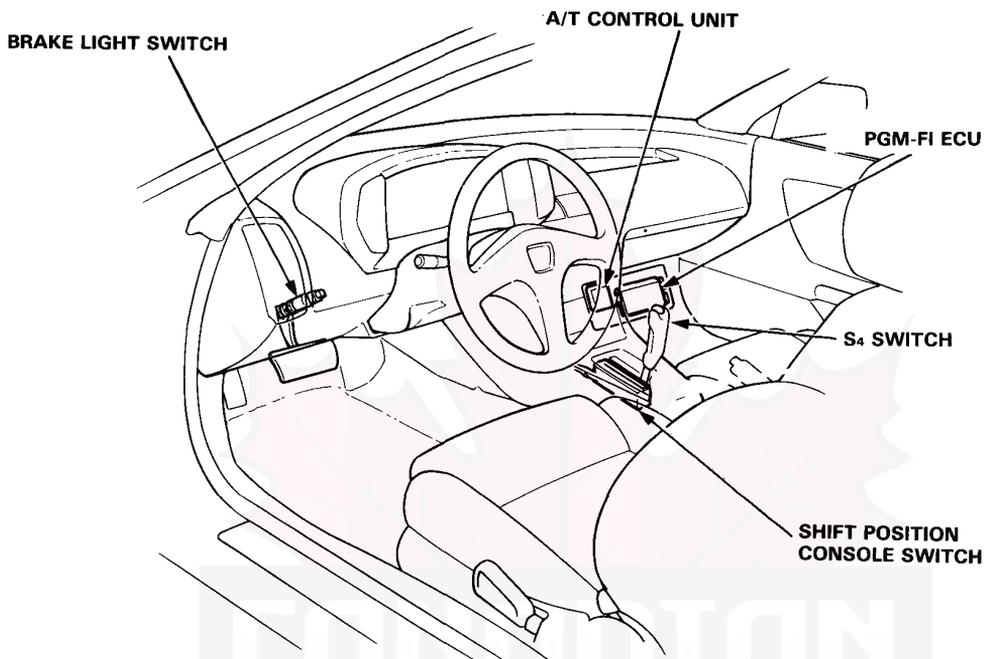

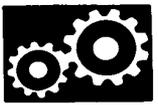

RHD:

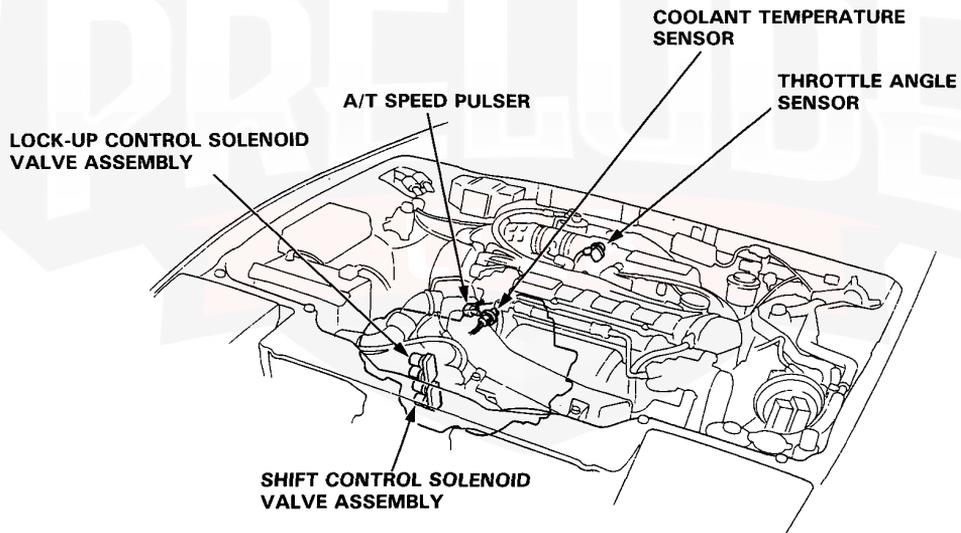
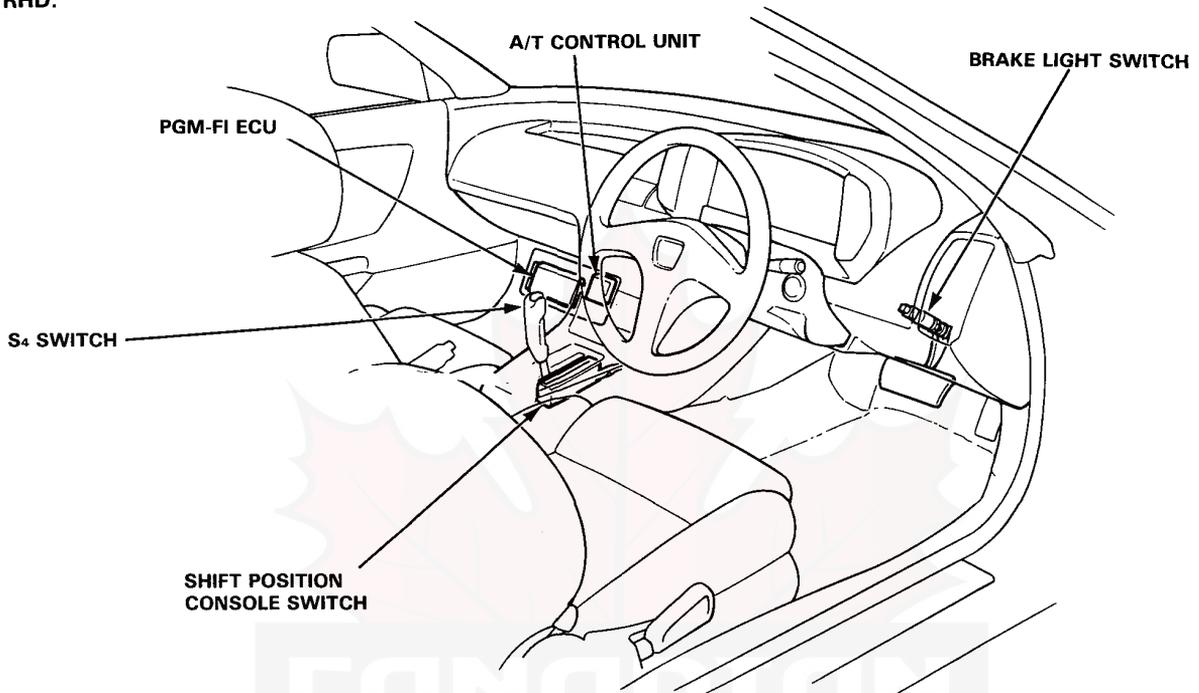

A/T Control Unit

Circuit Diagram

Carbureted engine (PGM-CARB):

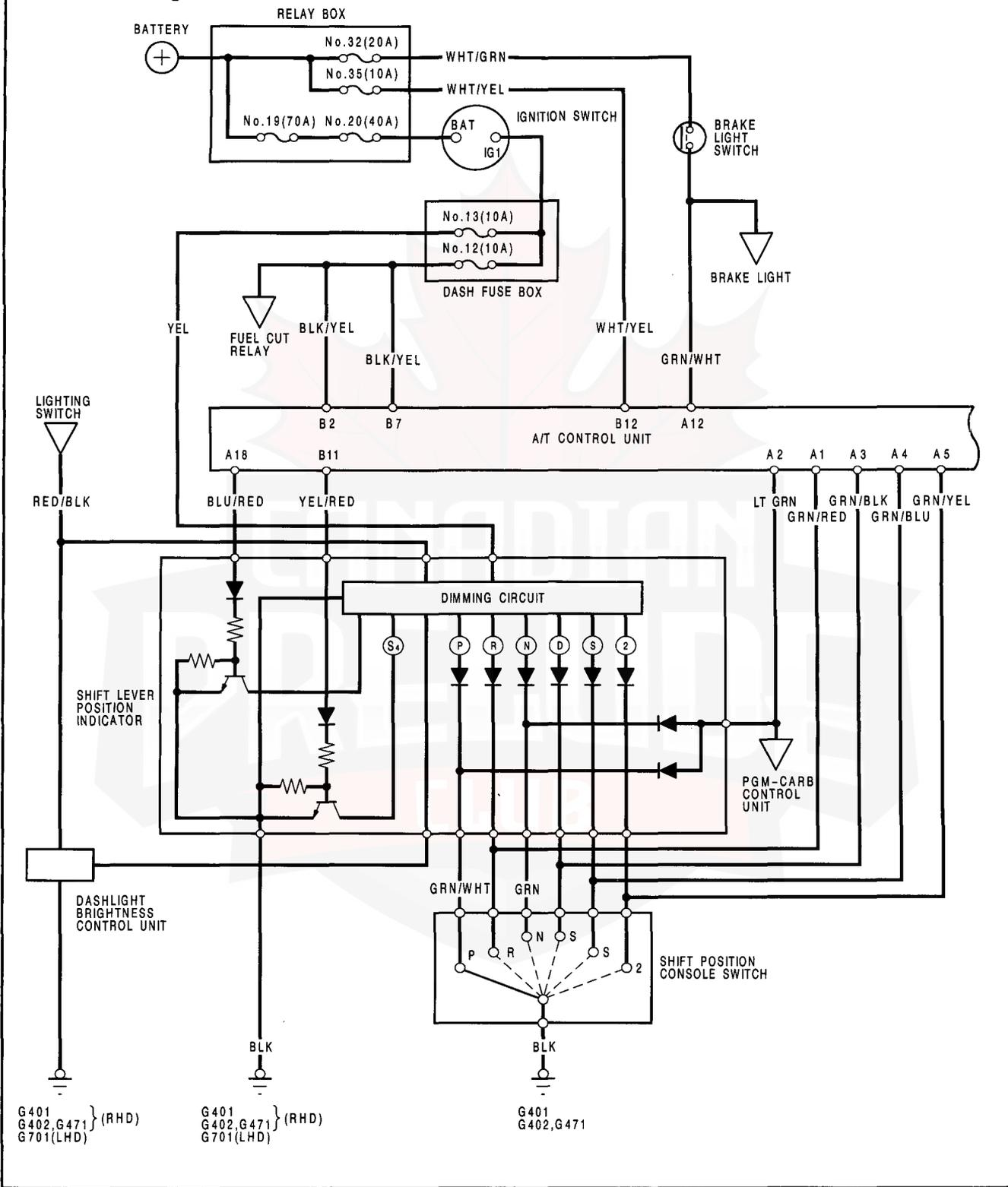

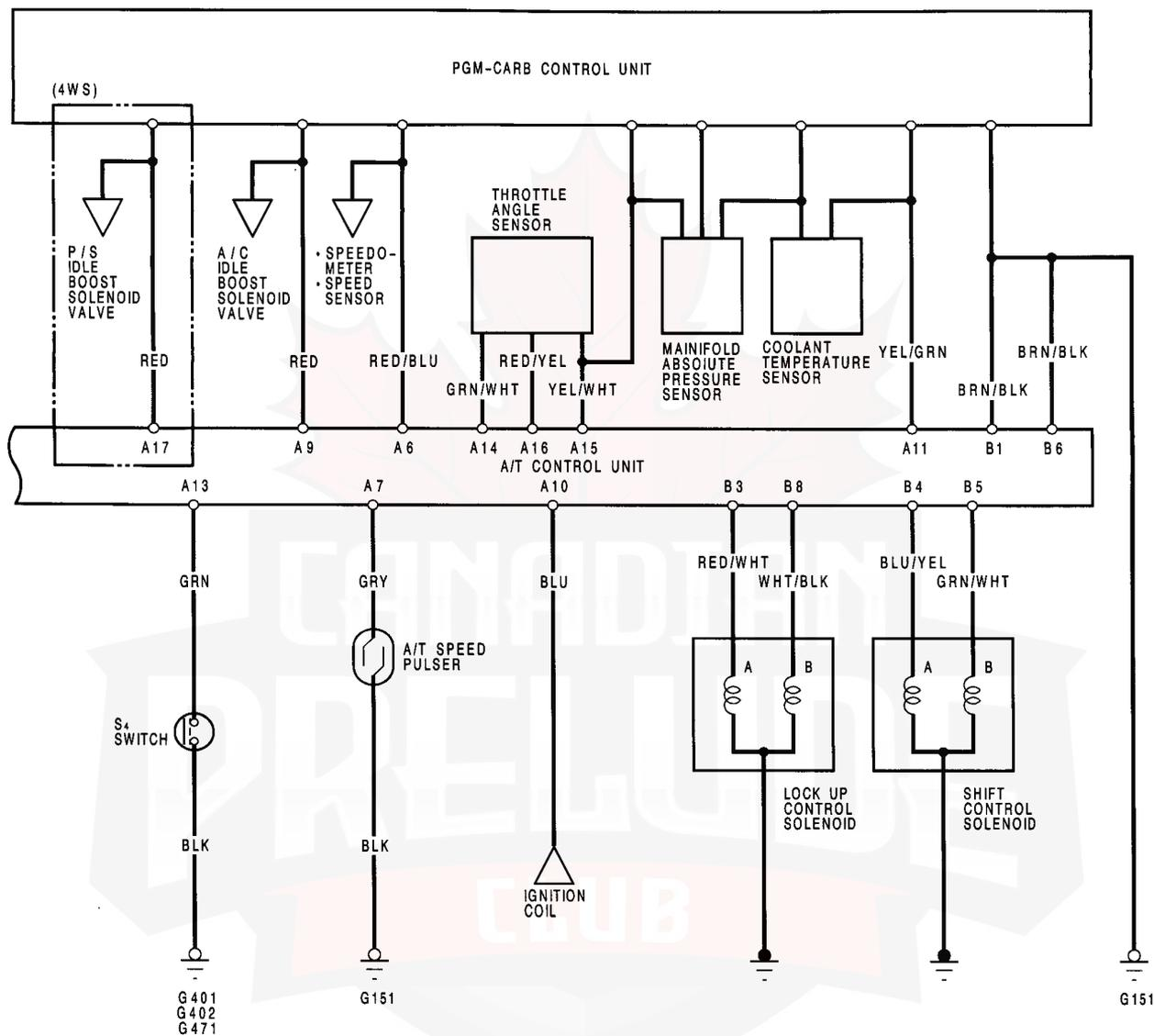
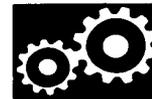

	A7	A6	A5		A4	A3	A2	A1	
A18	A17	A16	A15	A14	A13	A12	A11	A10	A9

	B5	B4		B3	B2	B1
B12	B11		B8	B7	B6	

TERMINAL LOCATION

NOTE: View from wire side.

A/T Control Unit

Circuit Diagram

Carbureted engine (Except PGM-CARB):

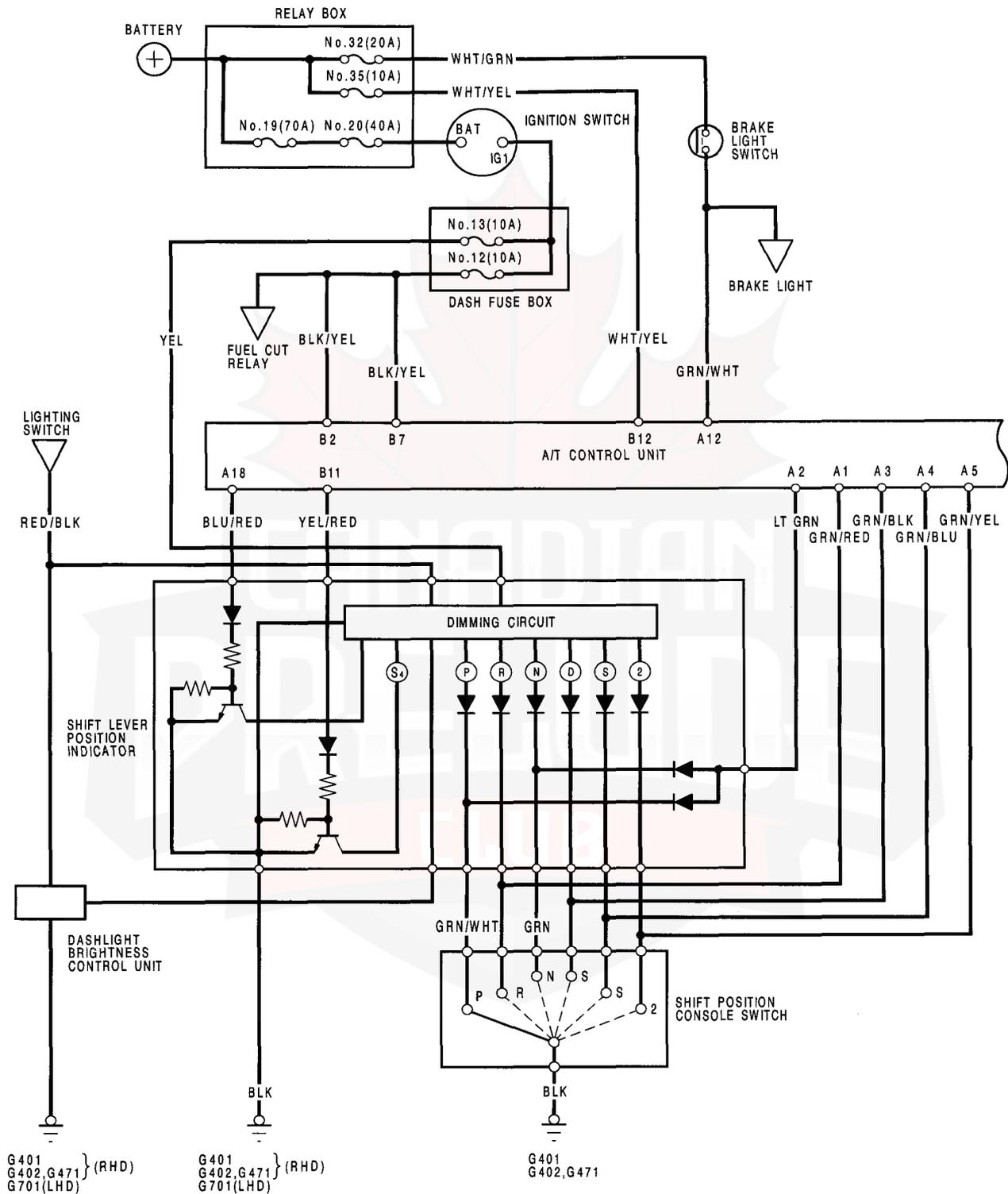

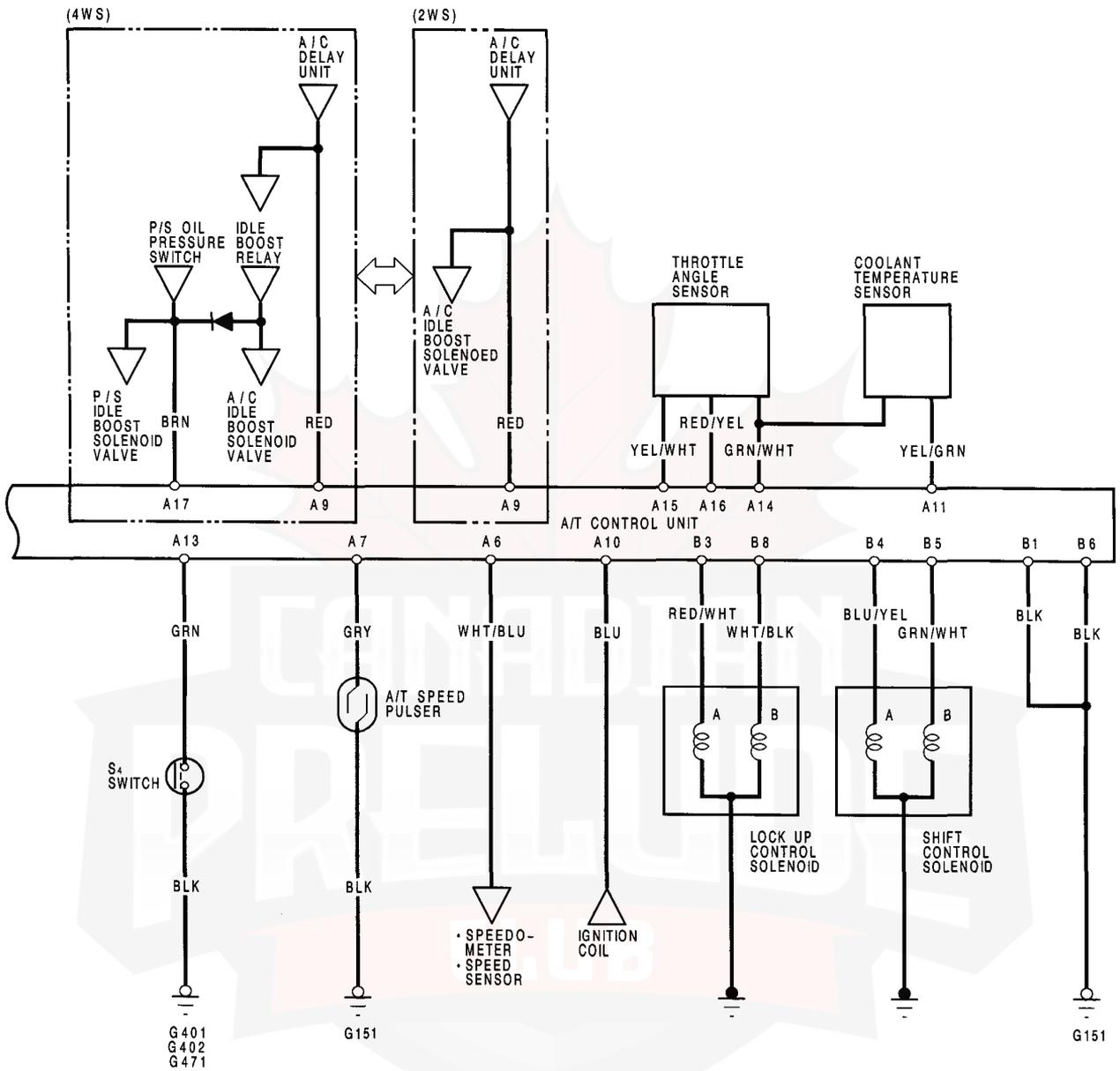
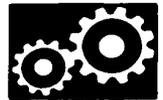

	A7	A6	A5		A4	A3	A2	A1	
A18	A17	A16	A15	A14	A13	A12	A11	A10	A9

	B5	B4		B3	B2	B1
B12	B11		B8	B7	B6	

TERMINAL LOCATION

NOTE: View from wire side.

A/T Control Unit

Circuit Diagram

Fuel-Injected engine:

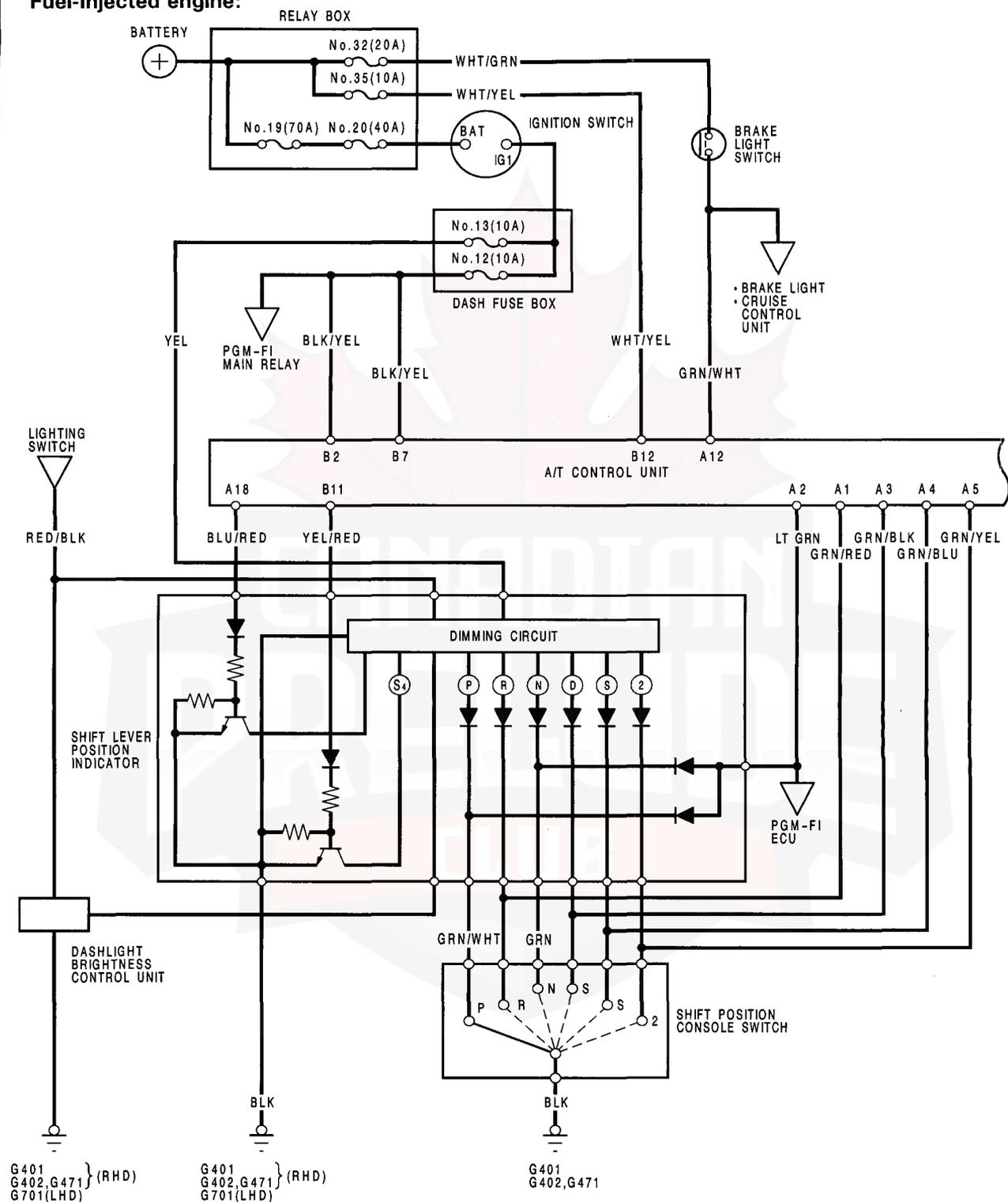

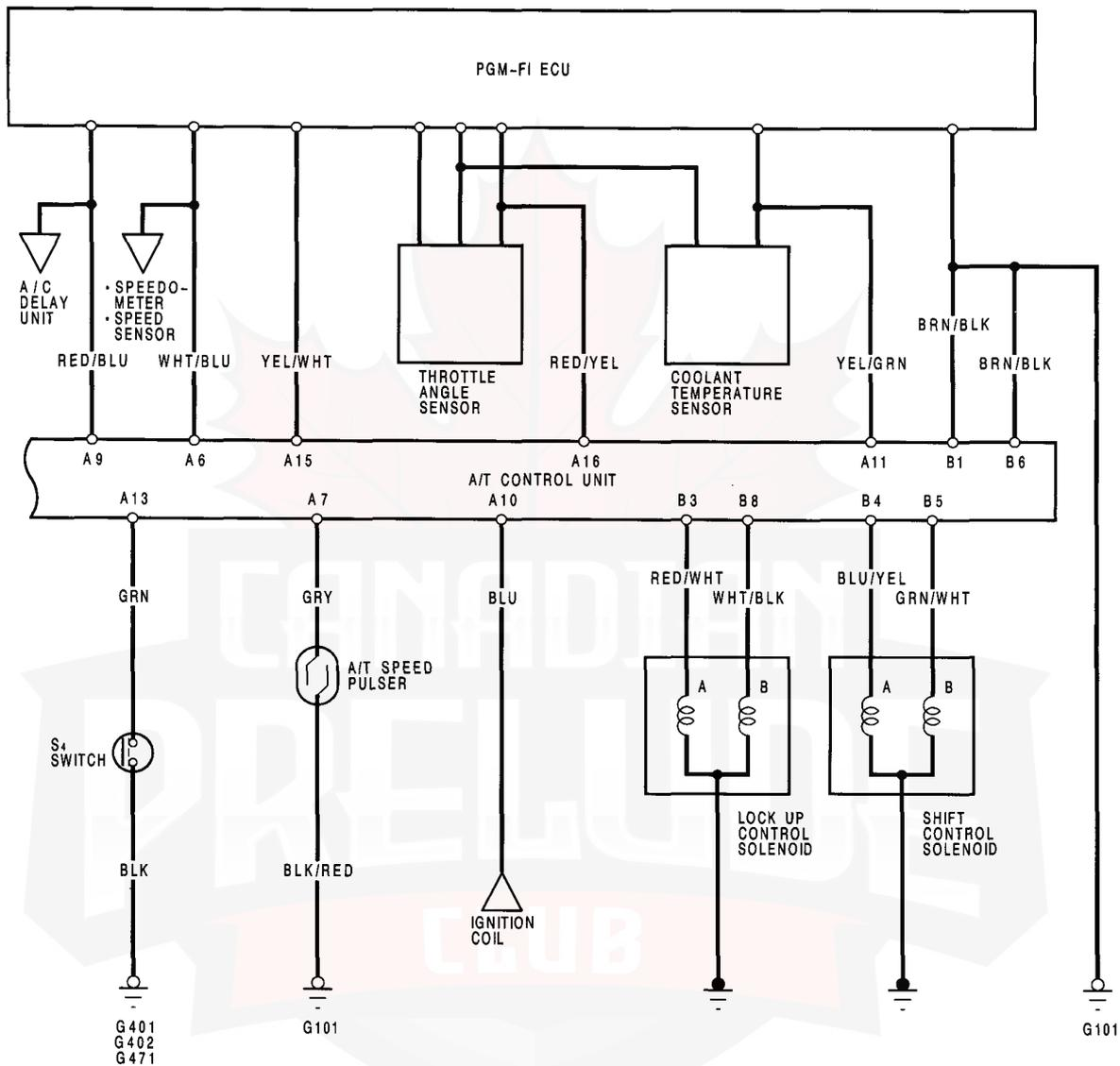
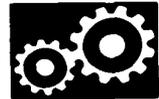

	A7	A6	A5		A4	A3	A2	A1
A18	A16	A15	A13	A12	A11	A10	A9	

	B5	B4		B3	B2	B1
B12	B11		B8	B7	B6	

TERMINAL LOCATION

NOTE: View from wire side.

Troubleshooting Procedures

The A/T Control Unit has a built-in self-diagnosis function. The S₄ indicator light in the gauge assembly and LED display on the A/T control unit blink when the A/T control unit senses an abnormality in the input or output systems. The number of blinks from the LED display varies according to the problem, which can be diagnosed by counting the number of blinks.

For problem diagnosis count the number of blinks from the LED display as shown on the Symptom-to-Component Chart on page 9-31. If no abnormality is found from your inspection, refer to the hydraulic system Symptom-to-Component Chart on page 9-57.

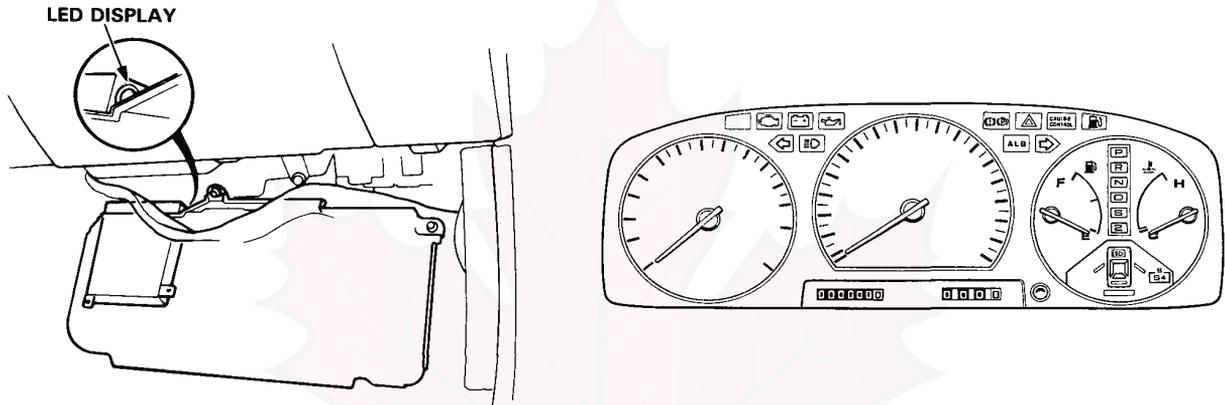

When the ignition switch is turned ON, the S₄ indicator light comes on for about two seconds regardless of whether there is a problem. The S₄ indicator light will also come on when in S₄ mode.

If there is a system problem, the S₄ indicator light will come on and continue to blink until the ignition key is turned OFF. When the ignition key is turned ON again, the S₄ indicator light will not blink again for the original problem. But if the A/T control unit senses the original abnormality again with ignition switch ON, the S₄ indicator light will blink again for the original problem. Therefore, even though the S₄ indicator light does not come on when turning the ignition key ON, check the LED display for automatic transmission problem diagnosis.

Since the LED problem code is retained in memory, it will blink again whenever the ignition key is turned on. If the LED problem code is not memorized, check the following causes:

- Check the EFI ECU fuse (10A) in the under-hood relay box.
- Check for an open circuit in the WHT/YEL wire between the EFI ECU fuse (10A) and A/T control unit B12 terminal.

After making repair, disconnect the EFI ECU fuse (10A) in the under-hood relay box for more than ten seconds to reset LED display memory.

Symptom-to-Component Chart

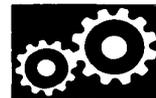

Electrical System

Number of LED display blinks	S4 indicator light	Symptom	Probable Cause	Ref. page
1	Blinks	<ul style="list-style-type: none"> Lock-up clutch does not engage. Lock-up-clutch does not disengage. Frequent engine stalling. 	<ul style="list-style-type: none"> Disconnected lock-up control solenoid valve A connector Open or short in lock-up control solenoid valve A wire Faulty lock-up control solenoid valve A 	9-36
2	Blinks	<ul style="list-style-type: none"> Lock-up clutch does not engage. 	<ul style="list-style-type: none"> Disconnected lock-up control solenoid valve B connector Open or short in lock-up control solenoid valve B wire Faulty lock-up control solenoid valve B 	9-37
3	Blinks or OFF	<ul style="list-style-type: none"> Lock-up clutch does not engage. 	<ul style="list-style-type: none"> Disconnected throttle angle sensor connector Open short in throttle angle sensor wire Faulty throttle angle sensor 	9-38 9-40
4	Blinks	<ul style="list-style-type: none"> Lock-up clutch does not engage. 	<ul style="list-style-type: none"> Disconnected speed pulser connector Open or short in speed pulser wire Faulty speed pulser 	9-41
5	Blinks	<ul style="list-style-type: none"> Fails to shift other than 2nd ↔ 4th gear. Lock-up clutch does not engage. 	<ul style="list-style-type: none"> Short in shift position console switch wire Faulty shift position console switch 	9-42
6	OFF	<ul style="list-style-type: none"> Fails to shift other than 2nd ↔ 4th gear. Lock-up clutch does not engage. Lock-up clutch engages and disengages alternately. 	<ul style="list-style-type: none"> Disconnected shift position console switch connector Open in shift position console switch wire Faulty shift position console switch. 	9-44
7	Blinks	<ul style="list-style-type: none"> Fails to shift other than 1st ↔ 4th, 2nd ↔ 4th, or 2nd ↔ 3rd gears. Fails to shift (stuck in 4th gear). 	<ul style="list-style-type: none"> Disconnected shift control solenoid valve A connector Open or short in shift control solenoid valve A wire Faulty shift control solenoid valve A 	9-46
8	Blinks	<ul style="list-style-type: none"> Fails to shift (stuck in 1st gear or 4th gear). 	<ul style="list-style-type: none"> Disconnected shift control solenoid valve B connector Open or short in shift control solenoid valve B wire Faulty shift control solenoid valve B 	9-47
9	Blinks	<ul style="list-style-type: none"> Lock-up clutch does not engage. 	<ul style="list-style-type: none"> Disconnected A/T speed pulser Open or short in A/T speed pulser wire Faulty A/T speed pulser 	9-48
10	Blinks	<ul style="list-style-type: none"> Lock-up clutch does not engage. 	<ul style="list-style-type: none"> Disconnected coolant temperature sensor connector Open or short in coolant temperature sensor wire Faulty coolant temperature sensor 	9-49 9-50
11	OFF	<ul style="list-style-type: none"> Lock-up clutch does not engage. 	<ul style="list-style-type: none"> Disconnected ignition coil connector Open or short in ignition coil wire Faulty ignition coil 	9-51

NOTE:

- If a customer describes the symptoms for codes 3, 6 or 11, yet the LED is not blinking, it will be necessary to recreate the symptom by test driving, and then checking the LED with the ignition STILL ON.
- If the LED display blinks 12 or more times, the control unit is faulty.

(cont'd)

Symptom-to-Component Chart

Electrical System (cont'd)

If the self-diagnosis LED indicator does not blink, perform an inspection according to the table listed below.

Symptom	INSPECTION		Probable Cause	Ref. page
	Carbureted engine	Fuel-injected engine		
<ul style="list-style-type: none"> S₄ indicator light does not come on with the ignition switch ON (S₄ indicator light should come on for about 2 sec.). Fails to shift (stuck in 4th gear). 	①	①	<ul style="list-style-type: none"> Loosely or poorly connected power line to control unit or disconnected control unit ground wire Open or short in S₄ indicator light wire Blown S₄ indicator light bulb 	9-33
<ul style="list-style-type: none"> S₄ won't engage. 	②	②	<ul style="list-style-type: none"> Open or short in S₄ switch wire Faulty S₄ switch 	9-34
<ul style="list-style-type: none"> At first, you step on the brake pedal with shift lever in N range, then fails to shift from 2nd to 1st gear when releasing brake pedal with shift lever shifted in S or D range from N range. 	③	③	<ul style="list-style-type: none"> Open or short in brake light switch wire 	9-35
<ul style="list-style-type: none"> Lock-up clutch turns ON and turns OFF alternately. 	④		<ul style="list-style-type: none"> Faulty A/C idle up solenoid valve driving signal. 	9-52
<ul style="list-style-type: none"> Lock-up clutch does not engage. 	④			



Electrical Troubleshooting

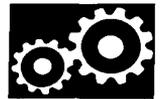

Troubleshooting Flow Chart

S₄ indicator light does not come on with the ignition switch ON. (It should come on for about 2 sec.)

Disconnect the 12 P connector from the control unit.

Check for continuity between the B1 (BRN/BLK) terminal and body ground, and between the B6 (BRN/BLK) terminal and body ground.

Is there continuity?

NO

YES

Turn the ignition switch ON.

Measure voltage between the B2 (BLK/YEL) and B1 (BRN/BLK) terminals, and between the B7 (BLK/YEL) and B1 terminals.

Is there battery voltage?

NO

YES

Turn the ignition switch OFF.

Measure resistance between the B11 (YEL/RED) and B1 (BRN/BLK) terminals.

Is the resistance more than 100 Ω?

NO

YES

Connect the 12P connector to the control unit.

Turn the ignition switch ON. Be sure that the voltage is available for 2 sec. between the B11 (YEL/RED) terminal and B1 (BRN/BLK) terminals.

Is the voltage 3-6 V?

YES

NO

Check for loose control unit connectors. If necessary, substitute a known good control unit and recheck.

View from wire side.

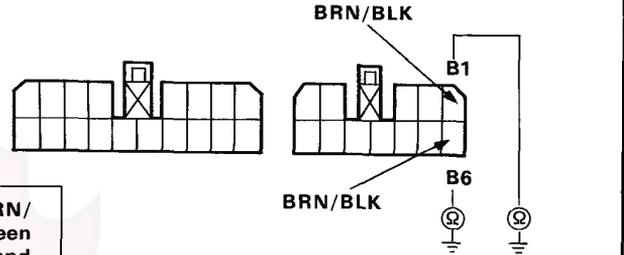

Repair open in BRN/BLK wire between the B1 terminal and G101/G151 and/or between the B6 terminal and G101/G151.

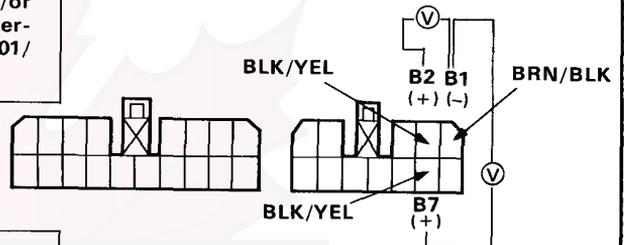

Repair open or short in BLK/YEL wire between the B2/B7 terminal and the dash fuse box.

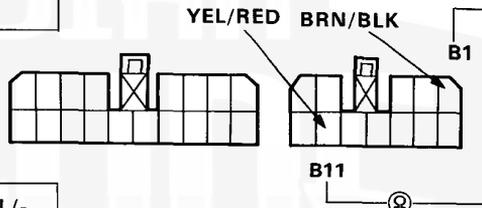

Repair Short in YEL/RED wire between the B11 terminal and the gauge assembly.

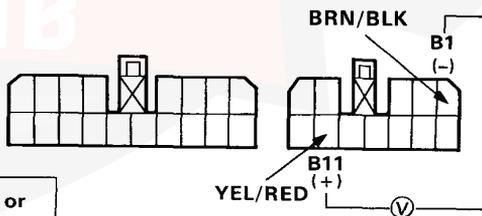

Check for open or short in YEL/RED wire between the B11 terminal and the gauge assembly. If wire is OK, check the S₄ Indicator Light Bulb and the Safety Indicator Circuit.

(cont'd)

Electrical Troubleshooting

Troubleshooting Flow Chart (cont'd)

S₄ won't engage.

Disconnect the 18P and 12P connectors from the control unit.

Check for continuity between the A13 (GRN) and B1 (BRN/BLK) terminals.

View from wire side.

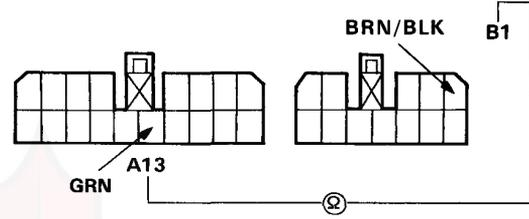

Is there continuity?

YES
Check for short in GRN wire between the A13 terminal and the S₄ switch. If wire is OK, check the S₄ Switch.

NO

Check for continuity between the A13 (GRN) and B1 (BRN/BLK) terminals while pressing the S₄ switch.

Is there continuity?

NO
Check for open in GRN wire between the A13 terminal and the S₄ switch. If wire is OK, check the S₄ Switch.

YES

Check for loose control unit connectors. If necessary, substitute a known good control unit and recheck.

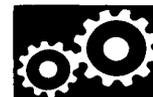

Fails to shift from 2nd to first on releasing the brake pedal when stopped in D or S.

Depress the brake pedal and check that the brake lights come on.

Do the lights come on?

NO
Repair the Brake Light Circuit.

YES

Disconnect the 18P and 12P connectors from the control unit.

Depress the brake pedal.

Measure the voltage between the A12 (GRN/WHT) and B1 (BRN/BLK) terminals.

Is there battery voltage?

NO
Repair open in GRN/WHT wire between the A12 and the brake light switch.

YES

Check for loose control unit connectors. If necessary, substitute a known good control unit and recheck.

View from wire side.

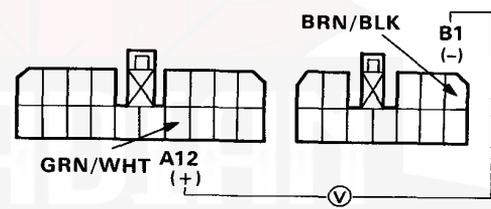

(cont'd)

Electrical Troubleshooting

Troubleshooting Flow Chart (cont'd)

Self-diagnosis LED indicator blinks once.

Disconnect the 12P connector from the control unit.

Turn the ignition switch ON.

Measure the voltage between the B3 (RED/WHT) and B1 (BRN/BLK) terminals.

Is there voltage? YES

Repair short to power source in RED/WHT wire between the B3 terminal and the lock-up solenoid valve A.

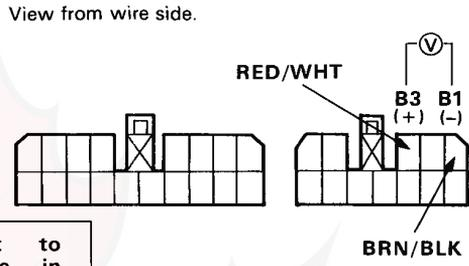

NO
Turn the ignition switch OFF.

Measure the resistance between the B3 (RED/WHT) and B1 (BRN/BLK) terminals.

Is the resistance 14-30Ω? NO

Check for open in RED/WHT wire between the B3 terminal and the lock-up solenoid valve A. If wire is OK, check the Lock-up Control Solenoid Valve A (page 9-55).

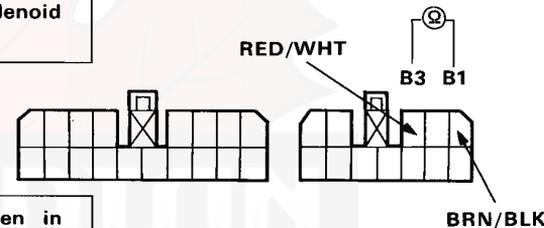

YES
Disconnect the 2P connector from the lock-up control solenoid valves assembly.

Check for continuity between the B3 (RED/WHT) and B1 (BRN/BLK) terminals.

Is there continuity? YES

Repair short to ground in RED/WHT wire between the B3 terminal and the lock-up control solenoid valve A.

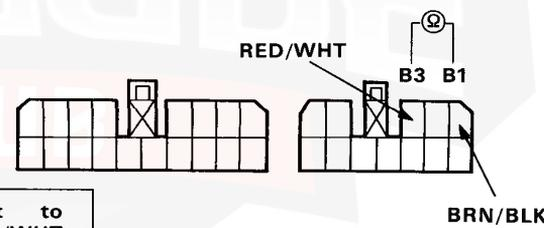

NO
Connect the 2P connector to the lock-up control solenoid valve assembly.

Check for loose control unit connectors. If necessary, substitute a known good control unit and recheck.



Self-diagnosis LED indicator blinks twice.

Disconnect the 12P connector from the control unit.

Turn the ignition switch ON.

Measure the voltage between the B8 (WHT/BLK) and B1 (BRN/BLK) terminals.

Is there voltage?

YES

NO

Turn the ignition switch OFF.

Measure the resistance between the B8 (WHT/BLK) and B1 (BRN/BLK) terminals.

Is the resistance 14-30 Ω ?

NO

YES

Disconnect the 2P connector from the lock-up control solenoid valves assembly.

Check for continuity between the B8 (WHT/BLK) and B1 (BRN/BLK) terminals.

Is there continuity?

YES

NO

Connect the 2P connector to the lock-up control solenoid valve assembly.

Check for loose control unit connectors. If necessary, substitute a known good control unit and recheck.

View from wire side.

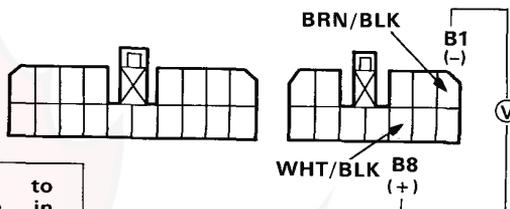

Repair short to power source in WHT/BLK wire between the B8 terminal and the lock-up control solenoid valve B.

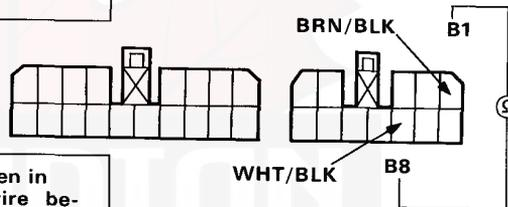

Check for open in WHT/BLK wire between the B8 terminal and the lock-up control solenoid valve B. If wire is OK, check the Lock-up Control Solenoid Valve B (page 9-55).

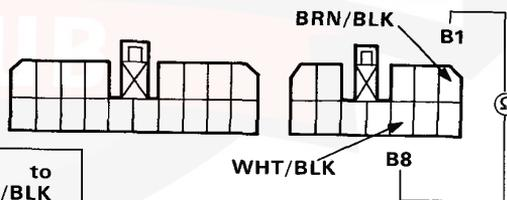

Repair short to ground in WHT/BLK wire between the B8 terminal and the lock-up control solenoid valve B.

(cont'd)

Electrical Troubleshooting

Troubleshooting Flow Chart (cont'd)

Self-diagnosis LED indicator blinks three times. (Carbureted engine)

Turn the ignition switch ON.

Check whether the PGM-CARB. LED display blinks.

Does the LED blink?

YES

Repair the PGM-CARB. system.

NO

Turn the ignition switch OFF.

⚠ WARNING

Throttle angle sensor is very near hot engine components

Connect the inspection adaptor between the throttle angle sensor and the engine wire harness.

Start the engine and warm it up to normal operating temperature.

Measure the voltage between the red clip (+) and green clip (-) of the adaptor.

Stop the engine and turn the ignition switch ON.

Is the voltage 4.50—5.50 V?

NO

Measure the voltage between the red clip (+) and body ground.

YES

Start the engine.

When the throttle valve opening is at idle angle, measure the voltage between the white clip (+) and the green clip (-) of the adaptor.

Is the voltage 4.50—5.50 V?

NO

Repair open or short circuit in YEL/WHT wire between the A15 terminal of the A/T control unit and the throttle angle sensor, and between the throttle angle sensor and the A7 terminal of the PGM-CARB control unit.

YES

Repair open in GRN/WHT wire between the A14 terminal and the throttle angle sensor.

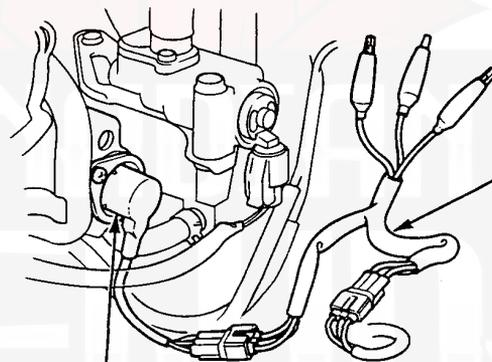

INSPECTION ADAPTOR
07GMJ-ML80100

THROTTLE ANGLE SENSOR

(To page 9-39)



(From page 9-38)

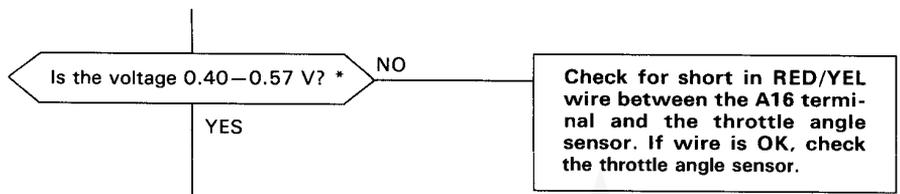

Stop the engine and turn the ignition switch ON.

When the throttle valve is fully opened, measure the voltage between the white clip (+) and the green clip (-).

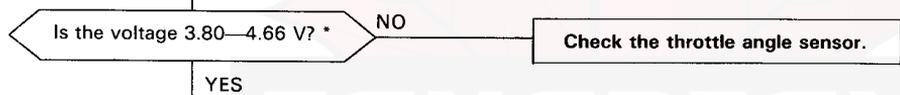

Start the engine.

When the throttle valve opening is at idle angle, measure the voltage between the A16 (RED/YEL) and A14 (GRN/WHT) terminals.

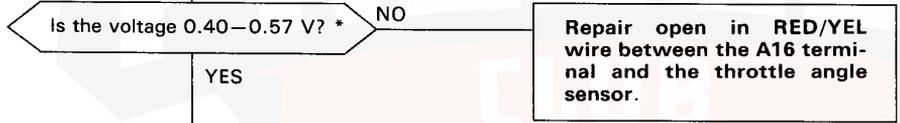
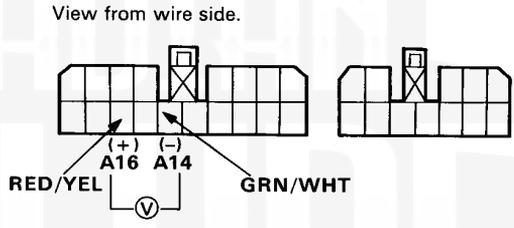

Check for loose control unit connectors. If necessary, substitute a known good control unit and recheck.

* ±10%

(cont'd)

Electrical Troubleshooting

Troubleshooting Flow Chart (cont'd)

Self-diagnosis LED indicator blinks three times. (Fuel-injected engine)

Turn the ignition switch ON.

Check whether the PGM-FI LED display blinks.

Does the LED blink? **YES** → Repair the PGM-FI System.

NO
Turn the ignition switch OFF.

Disconnect the 18P and 12P connectors from the control unit.

Turn the ignition switch ON.

Measure the voltage between the A15 (YEL/WHT) and B1 (BRN/BLK) terminals.

Is the voltage 4.75 — 5.25 V? **NO** → Repair open or short in YEL/WHT wire between the A15 terminal and the A10 terminal of the PGM-FI ECU.

YES
Turn the ignition switch OFF.

Connect the 18P and 12P connectors to the control unit.

Turn the ignition switch ON.

Measure the voltage between the A16 (RED/YEL) and B1 (BRN/BLK) terminals.

Is the voltage 0.44—0.56 V? * **NO** → Repair open or short in RED/YEL wire between the A16 terminal and the throttle angle sensor.

YES
Check for loose control unit connectors. If necessary, substitute a known good control unit and recheck.

View from wire side.

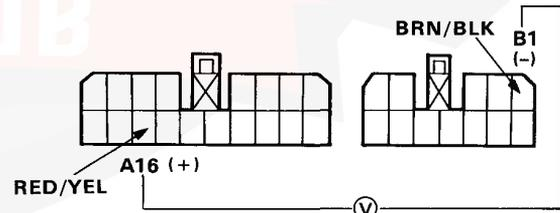
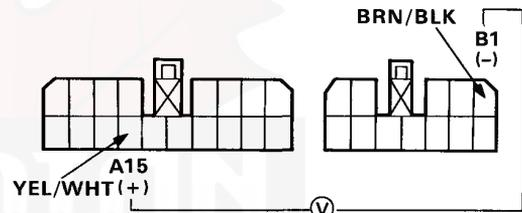

* ±10%

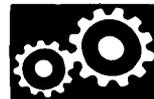

Self-diagnosis LED indicator blinks four times.

Jack up the front of the car and block one wheel.

⚠ WARNING

- Set the parking brake securely and block the rear wheels.
- Jack up the front of the car and support with a rigid rack.

Turn the ignition switch ON and shift transmission to N.

Rotate the front wheel and measure the voltage between the A6 (WHT/BLU) and B1 (BRN/BLK) terminals.

View from wire side.

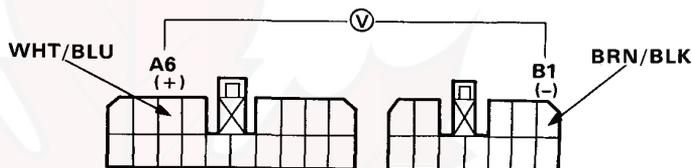

Does the voltage 0 — 5 V appear alternately?

NO

Turn the ignition switch OFF.

YES

Substitute a known good control unit and recheck.

Disconnect the 18P and 12P connectors from the control unit.

Turn the ignition switch ON.

Rotate the front wheel and check for voltage between the B1 (BRN/BLK) and A6 (WHT/BLU) terminals.

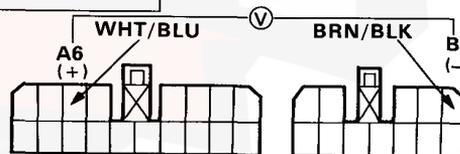

Does the voltage 0 — 5 V appear alternately?

NO

Check for short or open in WHT/BLU wire between the A6 terminal and the gauge assembly. If wire is OK, check the Speed Pulser.

YES

Check for loose control unit connectors. If necessary, substitute a known good control unit and recheck.

(cont'd)

Electrical Troubleshooting

Troubleshooting Flow Chart (cont'd)

Self-diagnosis LED indicator blinks five times.

Check the shift lever position indicator in gauge for operation.

Does it operate properly?

NO
Repair the Shift Lever Position Indicator Circuit.

YES

Turn the ignition switch ON.

Shift to other than R position.

Measure the voltage between the A1 (GRN/RED) and B1 (BRN/BLK) terminals.

Is there battery voltage?

NO
Check for short in GRN/RED wire between the A1 terminal and the shift position console switch. If wire is OK, check for loose connectors. If necessary, substitute a known good control unit and recheck.

YES

Shift to other than N and P position.

Measure the voltage between the A2 (LT GRN) and B1 (BRN/BLK) terminals.

Is there battery voltage?

NO
Check for short in LT GRN wire between the A2 terminal and the shift position console switch. If wire is OK, check for loose control unit connectors. If necessary, substitute a known good control unit and recheck.

YES

Shift to other than D position.

Measure the voltage between the A3 (GRN/BLK) and B1 (BRN/BLK) terminals.

Is there battery voltage?

NO
Check for short in GRN/BLK wire between the A3 terminal and the shift position console switch. If wire is OK, check for loose control unit connectors. If necessary, substitute a known good control unit and recheck.

YES

(To page 9-43)

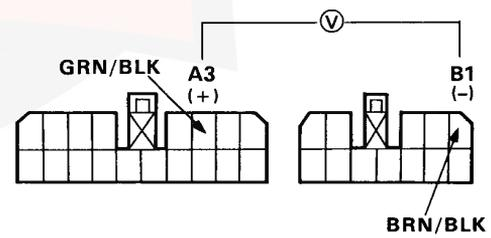
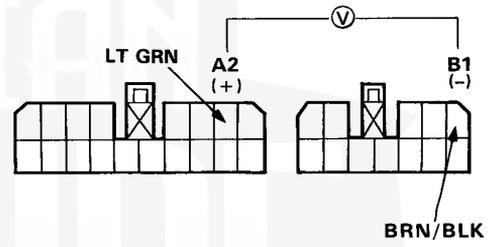
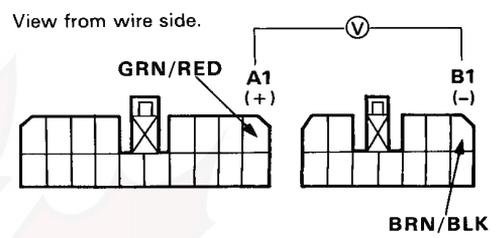

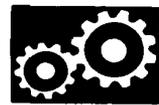

(From page 9-42)

Shift to other than S position.

Measure the voltage between the A4 (GRN/BLU) and B1 (BRN/BLK) terminals.

Is there battery voltage?

NO

YES

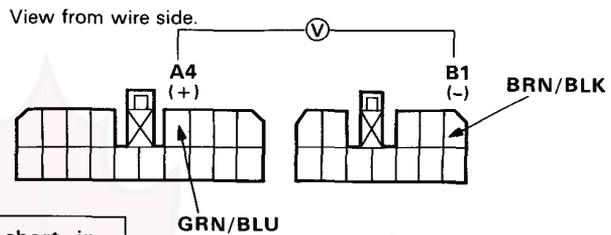

Check for short in GRN/BLU wire between the A4 terminal and the shift position console switch. If wire is OK, check for loose control unit connectors. If necessary, substitute a known good control unit and recheck.

Shift to other than 2 position.

Measure the voltage between the A5 (GRN/YEL) and B1 (BRN/BLK) terminals.

Is there battery voltage?

NO

YES

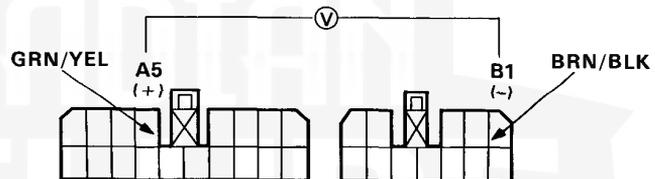

Check for short in GRN/YEL wire between the A5 terminal and the shift position console switch. If wire is OK, check for loose control unit connectors. If necessary, substitute a known good control unit and recheck.

Substitute a known good control unit and recheck.

(cont'd)

Electrical Troubleshooting

Troubleshooting Flow Chart (cont'd)

Self-diagnosis LED indicator blinks six times.

Turn the ignition switch ON.

Check the shift lever position indicator in gauge for operation.

Does it operate properly?

NO
Repair the Shift Lever Position Indicator Circuit.

Shift to R position.

Measure the voltage between the A1 (GRN/RED) and B1 (BRN/BLK) terminals.

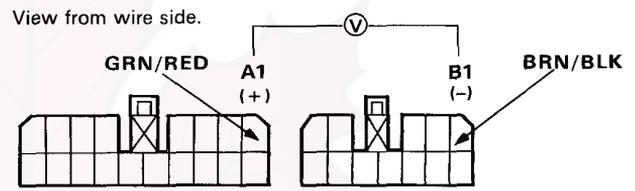

Is there voltage?

YES
Repair open in GRN/RED wire between the A1 terminal and the shift position console switch.

Shift to N and P position.

Measure the voltage between the A2 (LT GRN) and B1 (BRN/BLK) terminals.

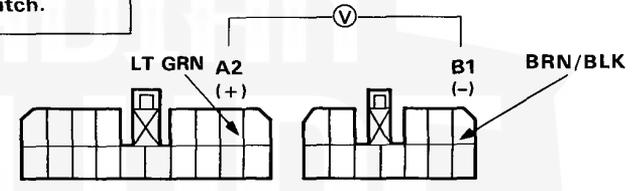

Is there voltage?

YES
Repair open in LT GRN wire between the A2 terminal and the shift position console switch.

Shift to D position.

Measure the voltage between the A3 (GRN/BLK) and B1 (BRN/BLK) terminals.

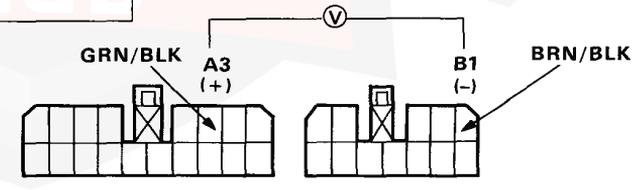

Is there voltage?

YES
Repair open in GRN/BLK wire between the A3 terminal and the shift position console switch.

(To page 9-45)

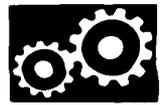

(From page 9-44)

Shift to S position.

Measure the voltage between the A4 (GRN/BLU) and B1 (BRN/BLK) terminals.

Is there voltage?

YES

NO

Shift to 2 position.

Measure the voltage between the A5 (GRN/YEL) and B1 (BRN/BLK) terminals.

Is there voltage?

YES

NO

Check for loose control unit connectors. If necessary, substitute a known good control unit and recheck.

View from wire side.

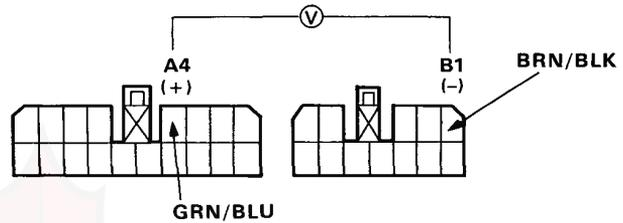

Repair open in GRN/BLU wire between the A4 terminal and the shift position console switch.

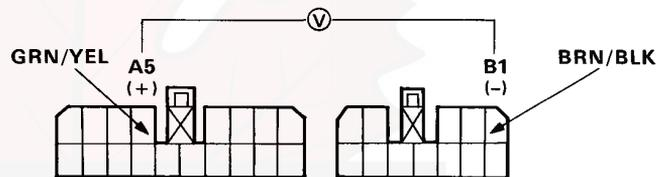

Repair open in GRN/YEL wire between the A5 terminal and the shift position console switch.

(cont'd)

Electrical Troubleshooting

Troubleshooting Flow Chart (cont'd)

Self-diagnosis LED indicator blinks seven times.

Disconnect the 12P connector from the control unit.

Turn the ignition switch ON.

Measure the voltage between the B4 (BLU/YEL) and B1 (BRN/BLK) terminals.

Is there voltage?

YES

Repair short to power source in BLU/YEL wire between the B4 terminal and the shift control solenoid valve A.

NO

Turn the ignition switch OFF.

Measure the resistance between the B4 (BLU/YEL) and B1 (BRN/BLK) terminals.

Is the resistance 12-24 Ω?

NO

Check for open in BLU/YEL wire between the B4 terminal and the shift control solenoid valve A. If wire is OK, check the Shift Control Solenoid Valve A (page 9-56).

YES

Disconnect the 2P connector from the shift control solenoid valves assembly.

Check for continuity between the B4 (BLU/YEL) and B1 (BRN/BLK) terminals.

Is there continuity?

YES

Repair short to ground in BLU/YEL wire between the B4 terminal and the shift control solenoid valve A.

NO

Connect the 2P connector to the shift control solenoid valves assembly.

Check for loose control unit connectors. If necessary, substitute a known good control unit and recheck.

View from wire side.

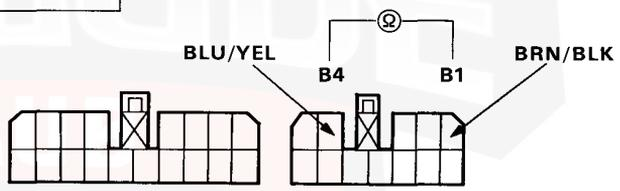
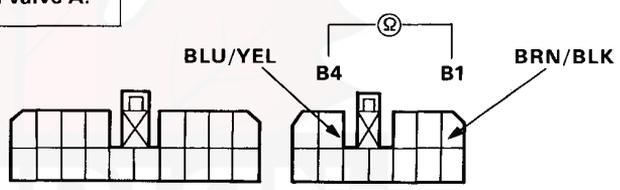
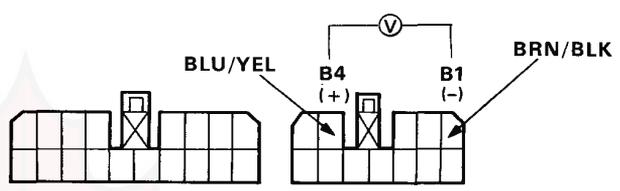

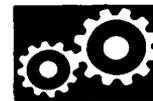

Self-diagnosis LED indicator blinks eight times.

Disconnect the 12P connector from the control unit.

Turn the ignition switch ON.

Measure the voltage between the B5 (GRN/WHT) and B1 (BRN/BLK) terminals.

Is there voltage? YES

Repair short to power source in GRN/WHT wire between the B5 terminal and the shift control solenoid valve B.

NO

Turn the ignition switch OFF.

Measure the resistance between the B5 (GRN/WHT) and B1 (BRN/BLK) terminals.

Is the resistance 12-24 Ω ? NO

Check for open in GRN/WHT wire between the B5 terminal and the shift control solenoid valve B. If wire is OK, check the Shift Control Solenoid Valve B (page 9-56).

YES

Disconnect the 2P connector from the shift control solenoid valves assembly.

Check for continuity between the B5 (GRN/WHT) and B1 (BRN/BLK) terminals.

Is there continuity? YES

Repair short to ground in GRN/WHT wire between the B5 terminal and the shift control solenoid valve B.

NO

Connect the 2P connector to the shift control solenoid valve assembly.

Check for loose control unit connectors. If necessary, substitute a known good control unit and recheck.

View from wire side.

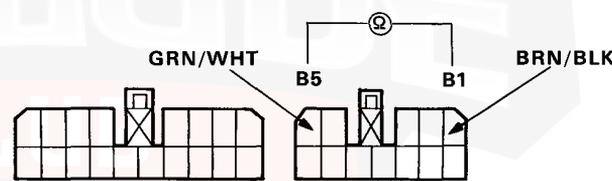
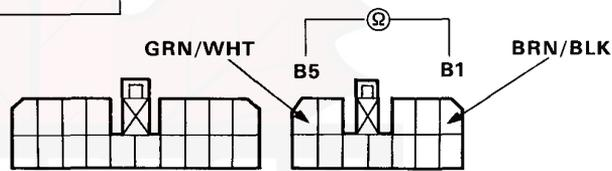
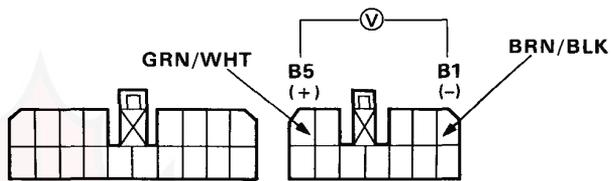

(cont'd)

Electrical Troubleshooting

Troubleshooting Flow Chart (cont'd)

Self-diagnosis LED indicator blinks nine times.

Jack up the front of the car.

- ⚠ WARNING**
- Set the parking brake securely and block the rear wheels.
 - Jack up the front of the car and support with a rigid rack.

Turn the ignition switch ON.

Rotate the front wheels and measure the voltage between the A7 (GRY) and B1 (BRN/BLK) terminals.

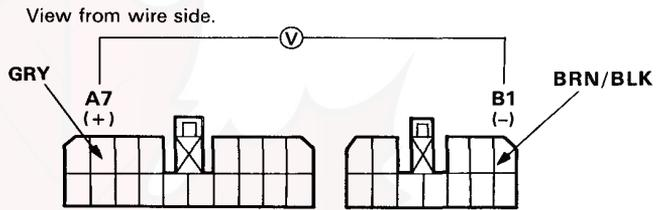

Do 0 and approx. 5 V appear alternately?

NO

Turn the ignition switch OFF.

Disconnect the 18P and 12P connectors from the control unit.

Rotate the front wheels and check for continuity between the A7 (GRY) and B1 (BRN/BLK) terminals.

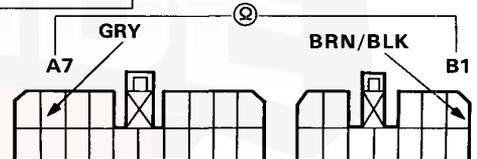

Do continuity and infinity alternately appear?

NO

Check for open or short in GRY wire between the A7 terminal and the A/T speed pulser. If wire is OK, check the A/T Speed Pulser (page 9-54).

YES

Check for loose control unit connectors. If necessary, substitute a known good control unit and recheck.

Substitute a known good control unit and recheck.

YES

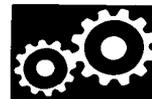

Self-diagnosis LED indicator blinks ten times. (Carbureted engine)

Turn the ignition switch ON.

Check whether the PGM-CARB. LED display blinks.

Does the LED blink? NO

Repair the PGM-CARB System.

Turn the ignition switch OFF.

Disconnect the 18P and 12P connectors from the control unit.

Turn the ignition switch ON.

Measure the voltage between the A15 (YEL/WHT) and B1 (BRN/BLK) terminals.

Is the voltage 4.50 — 5.50 V? NO

Repair open or short in YEL/WHT wire between the A15 terminal and the A7 terminal of the PGM-CARB control unit.

Turn the ignition switch OFF.

Connect the 18P and 12P connectors to the control unit.

Start the engine and warm it up to normal operating temperature.

Measure the voltage between the A11 (YEL/GRN) and B1 (BRN/BLK) terminals.

Is the voltage 0.70 — 1.60 V? NO

Repair open or short in YEL/GRN wire between the A11 terminal and the coolant temperature sensor.

Check for loose control unit connectors. If necessary, substitute a known good control unit.

View from wire side.

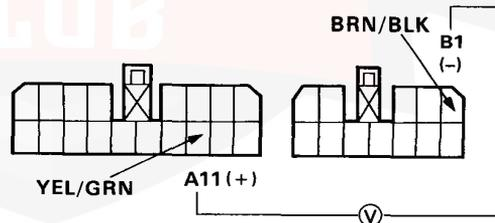
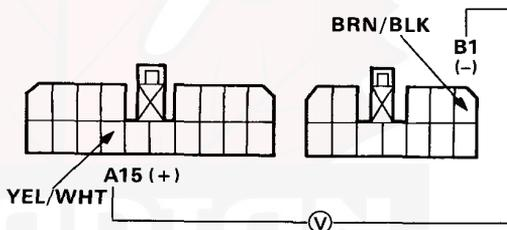

(cont'd)

Electrical Troubleshooting

Troubleshooting Flow Chart (cont'd)

Self-diagnosis LED indicator blinks ten times. (Fuel-injected engine)

Turn the ignition switch ON.

Check whether the PGM-FI LED display blinks.

Does the LED blink?

NO
Repair the PGM-FI System.

YES

Turn the ignition switch OFF.

Disconnect the 18P and 12P connectors from the control unit.

Turn the ignition switch ON.

Measure the voltage between the A15 (YEL/WHT) and B1 (BRN/BLK) terminals.

Is the voltage 4.75 — 5.25 V?

NO
Repair open or short in YEL/WHT wire between the A15 terminal and the A10 terminal of the PGM-FI ECU.

YES

Turn the ignition switch OFF.

Connect the 18P and 12P connectors to the control unit.

Start the engine and warm it up to normal operating temperature.

Measure the voltage between the A11 (YEL/GRN) and B1 (BRN/BLK) terminals.

Is the voltage 0.50 — 1.20 V?

NO
Repair open or short in YEL/GRN wire between the A11 terminal and the coolant temperature sensor.

YES

Check for loose control unit connectors. If necessary, substitute a known good control unit.

View from wire side.

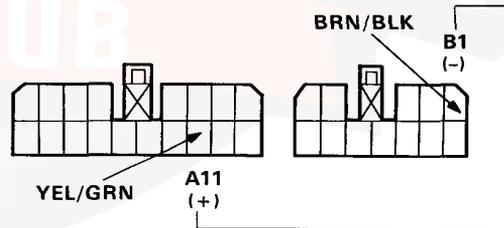
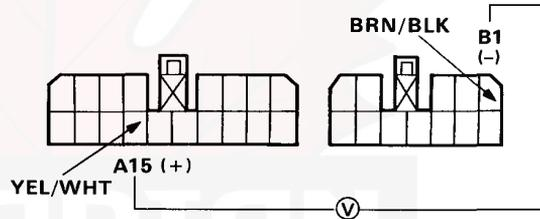

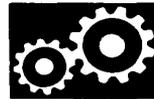

Self-diagnosis LED indicator blinks eleven times.

Disconnect the 18P and 12P connectors from the control unit.

Start the engine.

Measure the voltage between the A10 (BLU) and B1 (BRN/BLK) terminals.

Is there battery voltage?

NO
Repair open or short in BLU wire between the A10 terminal and the ignition coil.

YES

Check for loose control unit connectors. If necessary, substitute a known good control unit and recheck.

View from wire side.

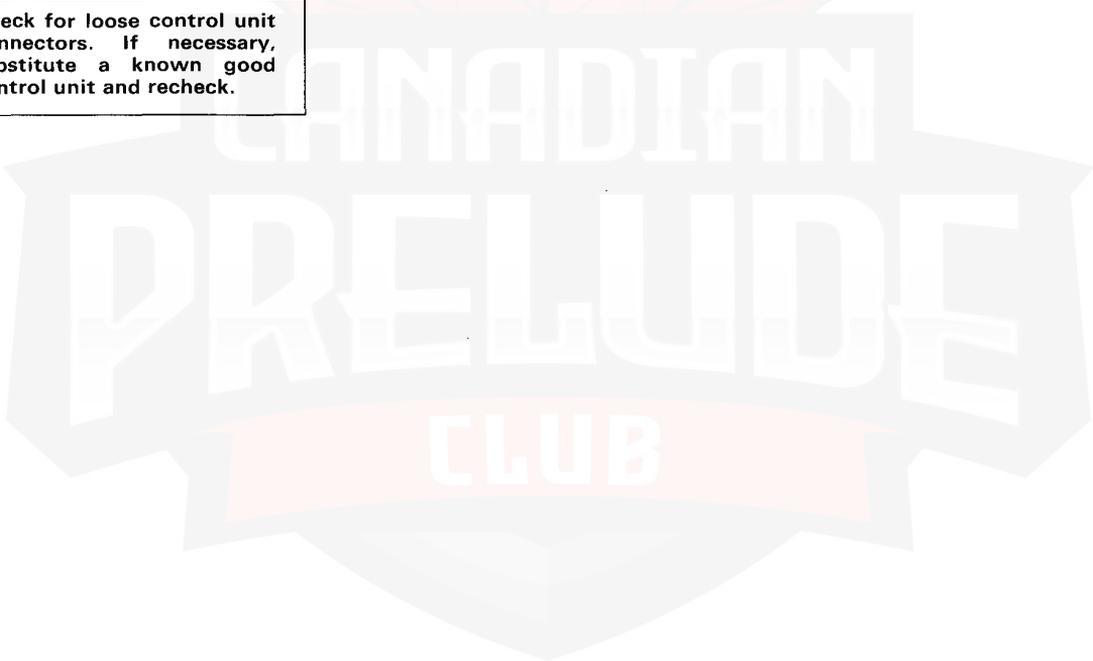
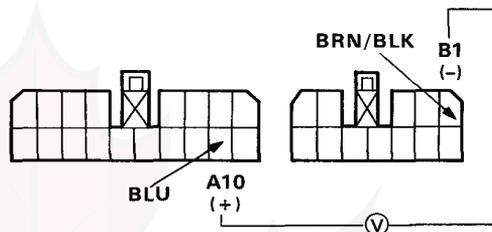

(cont'd)

Electrical Troubleshooting

Troubleshooting Flow Chart (cont'd)

A/C IDLE BOOST solenoid valve driving signal inspection (Carbureted engine)

Start the engine and warm it up to normal operating temperature.

Disconnect the 18P and 12P connectors from the control unit.

Turn on the air conditioner.

Measure the voltage between the A9 (RED) and B1 (BRN/BLK) terminals when the air conditioner is operating (air compressor is ON).

Is there battery voltage?

NO

Check for open circuit in RED wire between the A9 terminal and the B10 terminal of the PGM-CARB control unit. If wire is OK, check the PGM-CARB control unit.

YES

Driving signal is normal.

View from wire side.

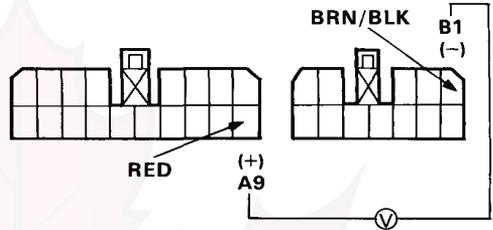

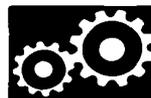

P/S IDLE BOOST solenoid valve driving signal inspection (Carbureted engine)

Start the engine and warm it up to normal operating temperature.

Disconnect the 18P and 12P connectors from the control unit.

Measure the voltage between the A17 (BRN) and B1 (BRN/BLK) terminals when the steering wheel is operating.

Is there battery voltage?

NO

YES

Driving signal is normal.

View from wire side.

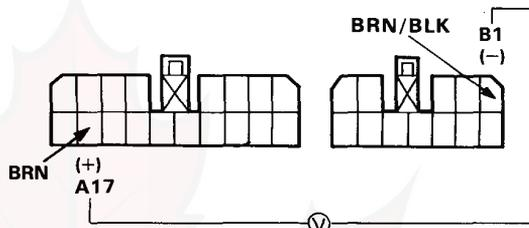

Check for open circuit in BRN wire between the A17 terminal and the D18 terminal of the PGM-CARB control unit. If wire is OK, check the PGM-CARB control unit.

A/T Speed Pulser

Test

1. Apply the parking brake, block the rear wheels and jack up the front of the car.
2. Disconnect the A/T speed pulser 2P connector.
3. Rotate the front wheels and be sure that continuity and no continuity appear alternately between the two terminals.

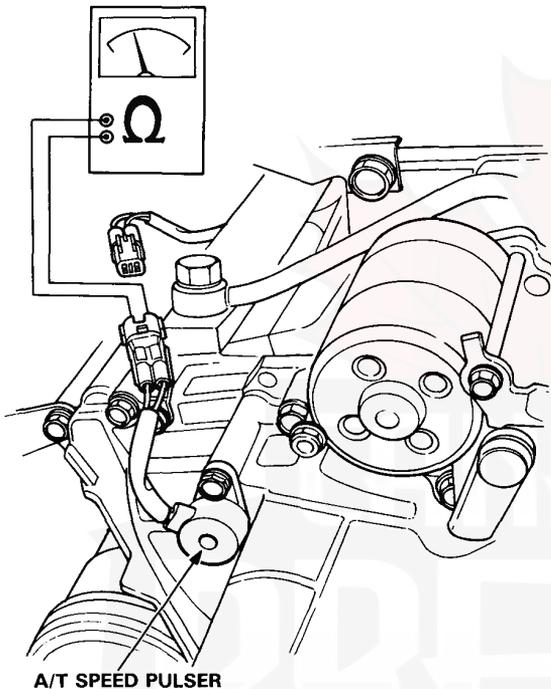

Removal/Inspection

1. Remove the 6 mm bolt from the transmission housing and remove the A/T speed pulser assembly.

O-RING
Replace.

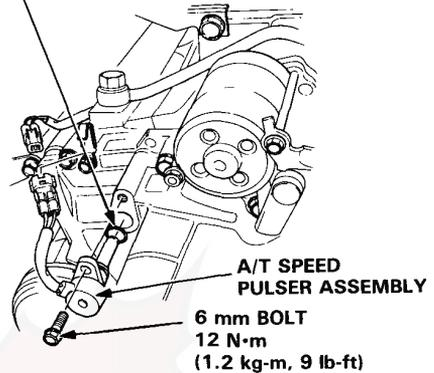

2. Bring a magnet close to the A/T speed pulser assembly and check for continuity.

BAR MAGNET

A/T SPEED PULSER ASSEMBLY

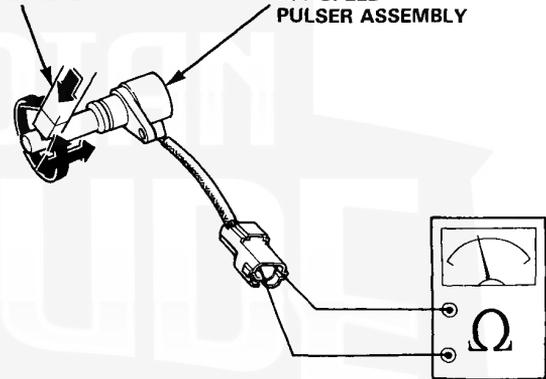

A/T speed pulser assembly is in good condition if there is:

- Continuity with a magnet close to the pulser assembly.
- No continuity with a magnet away from the pulser assembly.

NOTE: If it shows conductivity even once, it is a sign that the pulser works normally.

If the A/T speed pulser is normal, go to ATV Pulser Rotor Disassembly/Inspection.

3. Replace the O-ring with a new one before reassembling the A/T speed pulser.

CAUTION: Carefully inspect the A/T speed pulser before installing. Do not install it if it shows signs of being dropped or improperly handled.

Lock-up Control Solenoid Valve A/B



Test

NOTE: Lock-up control solenoid valves A and B must be removed/replaced as an assembly.

1. Disconnect the connector from the lock-up control solenoid valve A/B.

NOTE: Do not remove the lock-up control solenoid valve A/B stay.

2. Measure the resistance between the No.1 terminal (SOL. V A) of the lock-up control solenoid valve connector and body ground and between the No. 2 terminal (SOL. V B) and body ground.

STANDARD: 14–30 Ω

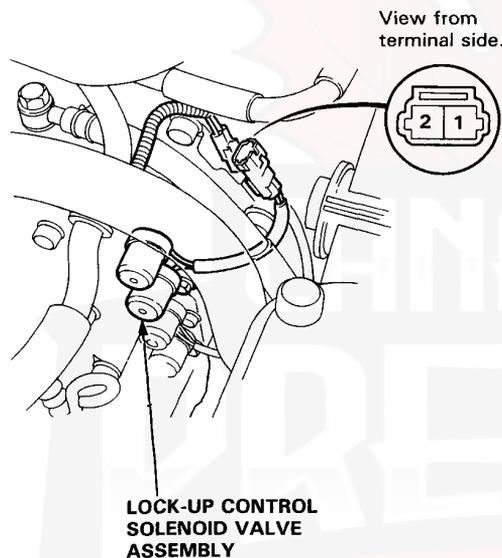

3. Replace the lock-up control solenoid valve assembly if the resistance is out of specification.
4. Connect the No. 1 terminal of the lock-up control solenoid valve connector to the battery positive terminal and body ground. A clicking sound should be heard each time the connection is made.
5. Connect the No. 2 terminal to the battery positive terminal and body ground.
6. If not, check for continuity between the A/T control unit B3 or B8 harness and body ground.
7. Replace the lock-up control solenoid valve assembly if there is continuity between the A/T control unit B3 or B8 harness and body ground.

Replacement

1. Remove the mounting bolts and lock-up control solenoid valve assembly.

NOTE: Be sure to remove or replace the lock-up control solenoid valves A and B as an assembly.

2. Check the lock-up control solenoid valve oil passages for dust or dirt and replace as an assembly, if necessary.

Clean the mounting surface and oil passages.

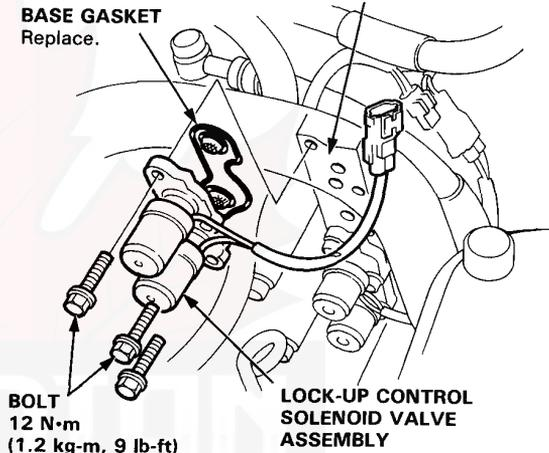

3. Clean the mounting surface and oil passages of the lock-up control solenoid valve assembly and install a new base gasket.
4. Check the connector for rust, dirt or oil and reconnect it securely.

Shift Control Solenoid Valve A/B

Test

NOTE: Shift control solenoid valves A and B must be removed/replaced as an assembly.

1. Disconnect the connector from the shift control solenoid valve A/B.

NOTE: Do not remove the shift control solenoid valve A/B stay.

2. Measure the resistance between the No.1 terminal (SOL. V A) of the solenoid valve connector and body ground and between the No.2 terminal (SOL. V B) and body ground.

STANDARD: 12–24 Ω

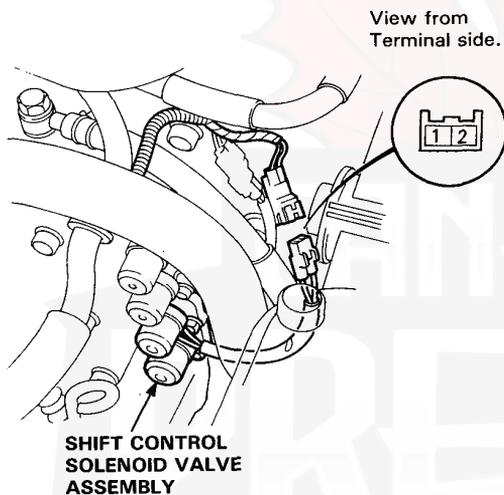

3. Replace the shift control solenoid valve assembly if the resistance is out of specification.
4. Connect the No.1 terminal of the solenoid valve connector to the battery positive terminal and the No.2 terminal to the battery positive terminal. A clicking sound should be heard each time the connection is made.
5. If not check for continuity between the harness and body ground.
6. Replace the shift control solenoid valve assembly if there is continuity between the harness and body ground.

Replacement

1. Remove the mounting bolts and shift control solenoid valve assembly.

NOTE: Be sure to remove or replace the shift control solenoid valves A and B as an assembly.

2. Check the shift control solenoid valve oil passages for dust or dirt and replace an assembly, if necessary.

BASE GASKET
Replace.

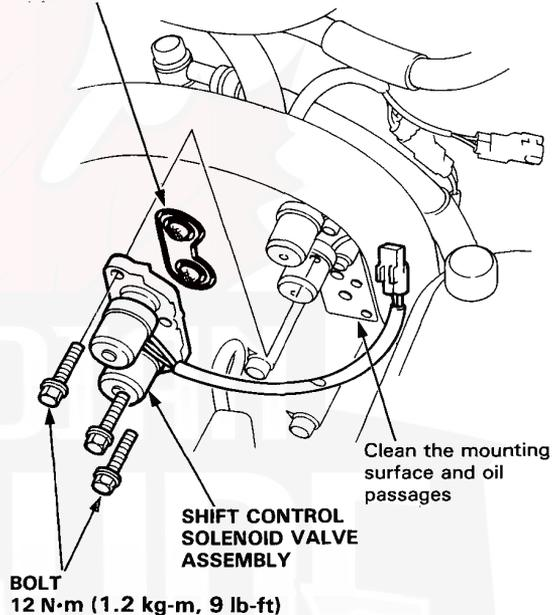

3. Clean the mounting surface and oil passages of the shift control solenoid valve assembly and install a new base gasket.
4. Check the connector for rust, dirt or oil and reconnect it securely.

Symptom-to-Component Chart

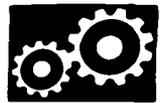

Hydraulic System

SYMPTOM	Check these items on the PROBABLE CAUSE LIST	Check these items on the NOTES CHART
Engine runs, but car does not move in any gear.	1, 6, 7, 16	K, L, R, S
Car moves in R and 2, but not in S or D.	8, 29, 44, 48	C, M, O
Car moves in S, D, R, but not in 2.	9, 30, 49	C, L
Car moves in S, D, 2, but not in R.	1, 11, 22, 34, 38, 39, 40	C, L, Q
Car moves in N.	1, 8, 9, 10, 11, 46, 47	C, D
Excessive idle vibration.	5, 17	B, K, L
Slips in all gears.	6, 7, 16	C, L, U
Slips in 1st gear.	8, 29, 44, 48	C, N, O, U
Slips in 2nd gear.	9, 20, 23, 30, 49	C, L, U
Slips in 3rd gear.	10, 21, 23, 31, 44	C, L, U
Slips in 4th gear.	11, 23, 32	C, L, U
Slips in reverse gear.	11, 32, 34	C
Flares on 1–2 upshift.	3, 15	E, L, V
Flares on 2–3 upshift.	3, 15, 24, 44	E, L, V
Flares on 3–4 upshift.	3, 15, 25, 44	E, L, V
No upshift, trans stays in 1st gear.	14, 19, 23	G, L
No downshift to 1st gear.	19	G, L
Late upshift.	14	L, V
Erratic shifting.	2, 14, 26	V
Harsh shift (up and down shifting)	2, 4, 15, 23, 24, 27, 47	A, E, H, I, L, V
Harsh shift (1–2).	2, 9	C, D, V
Harsh shift (2–3).	2, 10, 23, 24	C, D, H, L, V
Harsh shift (3–4).	2, 11, 23, 25	C, D, I, L, V
Harsh kickdown shifts.	2, 23, 27, 28	L, V, Q
Harsh kickdown shift (2–1).	48	O
Harsh downshift at closed throttle	15	E, T
Axle(s) slips out of trans on turns.	43, 50	L, P, Q
Axle(s) stuck in trans.	43	L, Q
Ratcheting noise when shifting into R.	6, 7, 38, 39, 40	K, L, Q
Loud popping noise when taking off in R.	38, 39, 40	L, Q
Ratcheting noise when shifting from R to P or from R to N.	38, 39, 40, 45	L, Q
Noise from trans in all selector lever positions.	6, 17	K, L, Q
Noise from trans only when wheels are rolling.	39, 42	L, Q
Gear whine, rpm related (pitch changes with shifts).	8, 41	K, L, Q
Gear whine, speed related (pitch changes with speed).	38, 42	L, Q
Trans will not shift into 4th gear in S4 or D.	1, 21, 28, 32	L
Lock-up clutch does not lock up smoothly.	17, 36, 37	L
Lock-up clutch does not operate properly.	2, 3, 15, 18, 35, 36, 37	E, L, V
Transmission has multitude of problems shifting. At disassembly, large particles of metal are found on magnet.	43	L, Q

(cont'd)

Symptom-to Component Chart

Hydraulic System (cont'd)

PROBABLE CAUSE	
1.	Shift cable broken/out of adjustment.
2.	Throttle cable too short.
3.	Throttle cable too long.
4.	Wrong type ATF.
5.	Idle rpm too low/high.
6.	Oil pump worn or binding.
7.	Pressure regulator stuck.
8.	1st clutch defective.
9.	2nd clutch defective.
10.	3rd clutch defective.
11.	4th clutch defective.
14.	Modulator valve stuck.
15.	Throttle B valve stuck.
16.	ATF strainer clogged.
17.	Torque convertor defective.
18.	Torque convertor check valve stuck.
19.	1-2 shift valve stuck.
20.	2-3 shift valve stuck.
21.	3-4 shift valve stuck.
22.	Servo control valve stuck.
23.	Clutch pressure control valve stuck.
24.	2nd orifice control valve stuck.
25.	Orifice control valve stuck.
26.	3-2 kickdown valve stuck.
27.	3rd kickdown valve stuck.
28.	4th exhaust valve stuck.
29.	1st accumulator defective.
30.	2nd clutch accumulator defective.
31.	3rd clutch accumulator defective.
32.	4th/reverse accumulator defective.
34.	Servo valve stuck.
35.	Lock-up clutch timing valve stuck.
36.	Lock-up clutch shift valve stuck.
37.	Lock-up clutch control valve stuck.
38.	Shift fork bent.
39.	Reverse gears worn/damaged (3 gears).
40.	Reverse selector worn.
41.	3rd gears worn/damaged (2 gears).
42.	Final gears worn/damaged (2 gears).
43.	Differential pinion shaft worn.
44.	Feedpipe O-ring broken.
45.	4th gears worn/damaged (2 gears).
46.	Gear clearance incorrect.
47.	Clutch clearance incorrect.
48.	Sprag clutch defective.
49.	Sealing rings/guide worn.
50.	Axle-inboard joint clip missing.

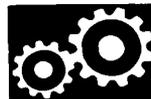

The following symptoms can be caused by improper repair or assembly.	Check these items on the PROBABLE CAUSE DUE TO IMPROPER REPAIR	Items on the NOTES CHART
Car creeps in N.	R1, R2	
Car does not move in S or D.	R4	
Trans locks up in R.	R3, R12	
Excessive drag in trans.	R6	R, K
Excessive vibration, rpm related.	R7	
Noise with wheels moving only.	R5	
Main seal pops out.	R8	S
Various shifting problems.	R9, R10	
Harsh upshifts.	R11	

PROBABLE CAUSE DUE TO IMPROPER REPAIR	
R1.	Improper clutch clearance.
R2.	Improper gear clearance.
R3.	Parking brake lever installed upside down.
R4.	Sprag clutch installed upside down.
R5.	Reverse hub installed upside down.
R6.	Oil pump binding.
R7.	Torque converter not fully seated in oil pump.
R8.	Main seal improperly installed.
R9.	Springs improperly installed.
R10.	Valves improperly installed.
R11.	Ball check valves not installed.
R12.	Shift fork bolt not installed.

(cont'd)

Symptom-to-Component Chart

Hydraulic System (cont'd)

NOTES	
A.	Flush ATF in the ATF cooler.
B.	Set idle rpm in gear to specified idle speed. If still no good, adjust motor mounts as outlined in engine section of service manual.
C.	If the large clutch piston O-ring is broken, inspect the piston groove for rough machining.
D.	If the clutch pack is seized or is excessively worn, inspect the other clutches for wear and check the orifice control valves and throttle valves for free movement.
E.	If throttle valve B is stuck, inspect the clutches for wear.
G.	If the 1-2 valve is stuck closed, the transmission will not upshift. If stuck open the transmission has no 1st gear.
H.	If the 2nd orifice control valve is stuck, inspect the 2nd and 3rd clutch packs for wear.
I.	If the orifice control valve is stuck, inspect the 3rd and 4th clutch packs for wear.
J.	If the clutch pressure control valve is stuck closed, the transmission will not shift out of 1st gear.
K.	Improper alignment of main valve body and torque converter case may cause oil pump seizure. The symptoms are mostly an rpm-related ticking noise or a high pitched squeek.
L.	If the oil screen is clogged with particles of steel or aluminum, inspect the oil pump and differential pinion shaft. If both are OK and no cause for the contamination is found, replace the torque converter.
M.	If the 1st clutch feedpipe guide in the end cover is scored by the mainshaft, inspect the ball bearing for excessive movement in the transmission housing. If OK, replace the end cover as it is dented. The O-ring under the guide is probably worn.
N.	Replace the mainshaft if the bushings for the 1st and 4th feedpipe are loose or damaged. If the 1st feedpipe is damaged or out of round, replace it. If the 4th feedpipe is damaged or out of round, replace the end cover.
O.	A worn or damaged sprag clutch is mostly a result of shifting the trans in S or D while the wheels rotate in reverse, such as rocking the car in snow.
P.	Inspect the frame for collision damage.
Q.	Inspect for damage or wear: 1. Reverse selector gear teeth chamfers. 2. Engagement teeth chamfers of countershaft 4th and reverse gear. 3. Shift fork for scuff marks in center. 4. Differential pinion shaft for wear under pinion gears. 5. Bottom of 3rd clutch for swirl marks. Replace items 1, 2, 3 and 4 if worn or damaged. If trans makes clicking, grinding or whirring noise, also replace mainshaft 4th gear and reverse idler gear and countershaft 4th gear in addition to 1, 2, 3 or 4. If differential pinion shaft is worn, overhaul differential assembly and replace oil screen and thoroughly clean trans, flush torque converter, cooler and lines. If bottom of 3rd clutch is swirled and trans makes gear noise, replace the countershaft and ring gear.
R.	Be very careful not to damage the torque converter case when replacing the main ball bearing. You may also damage the oil pump when you torque down the main valve body. This will result in oil pump seizure if not detected. Use proper tools.
S.	Install the main seal flush with the torque converter case. If you push it into the torque converter case until it bottoms out, it will block the oil return passage and result in damage.
T.	Harsh downshifts when coasting to a stop with zero throttle may be caused by a bent-in throttle valve retainer/cam stopper. Throttle cable adjustment may clear this problem.
U.	Check if servo valve stopper cap is installed. If it was not installed, the check valve may have been pushed out by hydraulic pressure causing a leak (internal) affecting all forward gears.
V.	Throttle cable adjustment is essential for proper operation of the transmission. Not only does it affect the shift points if misadjusted, but also the shift quality and lock-up clutch operation. A too long adjusted cable will result in throttle pressure being too low for the amount of engine torque input into the transmission and may cause clutch slippage. A too short adjusted cable will result in too high throttle pressures which may cause harsh shifts, erratic shifts and torque converter hunting.

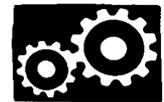

NOTE: After transmission is installed.

- Make sure the floor mat does not interfere with accelerator pedal travel. Fully depress accelerator pedal and check to make sure the throttle lever is fully opened.
- Release the accelerator pedal and check both inner control cables to be sure they have slight play.

Warm up the engine to operating temperature.

D and **S** Range

1. Apply parking brake and block the wheels. Start the engine, then move the selector to **D** while depressing the brake pedal. Depress the accelerator pedal, and release it suddenly. Engine should not stall.
2. Check that shift points occur at approximate speeds shown. Also check for abnormal noise and clutch slippage.
3. Apply parking brake and block the wheels. Start the engine, then move the selector **S** while depressing the brake pedal. Depress the accelerator pedal, and release it suddenly. Engine should not stall.

KE, KF, KB, KW, KY, KT models:

(Carburetor)

- **Upshift**

			1st–2nd	2nd–3rd	3rd–4th	LC.ON
1/12 throttle Coasting down-hill from a stop	km/h		12–16	27–32	44–50	16–20
	mph		7–10	17–20	27–31	10–12
7/16 throttle Acceleration from a stop	km/h		33–37	56–63	76–86	98–102
	mph		21–23	35–39	47–53	61–63
Full-throttle Acceleration from a stop	km/h		53–60	102–109	147–155	132–136
	mph		33–37	63–68	91–96	82–85

S (with S₄ switch in operation)

			1st–2nd	2nd–3rd	3rd–4th	LC.ON
1/12 throttle Coasting down-hill from a stop	km/h		18–22	40–45	45–51	23–27
	mph		11–14	25–28	28–32	14–17
7/16 throttle Acceleration from a stop	km/h		38–42	66–73	104–114	120–124
	mph		24–26	41–45	65–71	75–77
Full-throttle Acceleration from a stop	km/h		53–60	102–109	147–155	132–136
	mph		33–37	63–68	91–96	82–85

- **Downshift**

			LC.OFF	4th–3rd	3rd–2nd	2nd–1st
1/12 throttle Coasting or braking to a stop	km/h		14–18	28–33	—	8–12
	mph		9–11	17–21	—	5–7
7/16 throttle When car is slowed by increased grade, wind, etc.	km/h		88–92	—	—	—
	mph		55–57	—	—	—
Full-throttle When car is slowed by increased grade, wind, etc.	km/h		130–134	124–133	82–91	38–46
	mph		81–83	77–83	51–57	24–29

S (with S₄ switch in operation)

			LC.OFF	4th–3rd	3rd–2nd	2nd–1st
1/12 throttle Coasting or braking to a stop	km/h		21–25	33–38	—	11–15
	mph		13–16	21–24	—	7–9
7/16 throttle When car is slowed by increased grade, wind, etc.	km/h		99–103	—	—	—
	mph		62–64	—	—	—
Full-throttle When car is slowed by increased grade, wind, etc.	km/h		130–134	124–133	82–91	38–46
	mph		81–83	77–83	51–57	24–29

(cont'd)

Road Test

KE, KF, KB, KW, KY, KT models:

(PGM-FI)

• Upshift

D

		1st-2nd	2nd-3rd	3rd-4th	LC.ON
1/12 throttle Coasting down-hill from a stop	km/h	12-16	27-32	44-50	16-20
	mph	7-10	17-20	27-31	10-12
7/16 throttle Acceleration from a stop	km/h	27-33	51-58	72-82	98-102
	mph	17-21	32-36	45-51	61-63
Full-throttle Acceleration from a stop	km/h	53-60	106-113	157-165	135-139
	mph	33-37	66-70	98-103	84-86

S (with S₄ switch in operation)

		1st-2nd	2nd-3rd	3rd-4th	LC.ON
1/12 throttle Coasting down-hill from a stop	km/h	18-22	28-33	45-51	23-27
	mph	11-14	17-21	28-32	14-17
7/16 throttle Acceleration from a stop	km/h	37-43	71-78	104-114	120-124
	mph	23-27	44-48	65-71	75-77
Full-throttle Acceleration from a stop	km/h	53-60	106-113	152-162	135-139
	mph	33-37	66-70	94-101	84-86

• Downshift

D

		LC.OFF	4th-3rd	3rd-2nd	2nd-1st
1/12 throttle Coasting or braking to a stop	km/h	14-18	28-33	—	10-14
	mph	9-11	17-21	—	6-9
7/16 throttle When car is slowed by increased grade, wind, etc.	km/h	88-92	—	—	—
	mph	55-57	—	—	—
Full-throttle When car is slowed by increased grade, wind, etc.	km/h	132-136	126-135	88-97	42-50
	mph	82-85	78-84	55-60	26-31

S (with S₄ switch in operation)

		LC.OFF	4th-3rd	3rd-2nd	2nd-1st
1/12 throttle Coasting or braking to a stop	km/h	21-25	33-38	—	13-17
	mph	13-16	21-24	—	8-11
7/16 throttle When car is slowed by increased grade, wind, etc.	km/h	99-103	—	—	—
	mph	62-64	—	—	—
Full-throttle When car is slowed by increased grade, wind, etc.	km/h	132-136	126-135	88-97	42-50
	mph	82-85	78-84	55-60	26-31

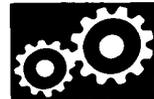

KS, KZ, KX models:

(Carburetor)

• **Upshift**

D

		1st–2nd	2nd–3rd	3rd–4th	LC.ON
1/12 throttle Coasting down-hill from a stop	km/h	18–21	32–39	42–51	21–27
	mph	11–13	20–24	26–32	13–17
7/16 throttle Acceleration from a stop	km/h	27–34	53–63	87–97	95–101
	mph	17–21	33–39	54–60	59–63
Full-throttle Acceleration from a stop	km/h	55–63	101–111	148–158	130–137
	mph	34–39	63–69	92–98	81–85

S (with S₄ switch in operation)

		1st–2nd	2nd–3rd	3rd–4th	LC.ON
1/12 throttle Coasting down-hill from a stop	km/h	18–21	34–40	58–68	35–42
	mph	11–13	21–25	36–42	22–26
7/16 throttle Acceleration from a stop	km/h	27–34	63–72	106–116	114–121
	mph	17–21	39–45	66–72	71–75
Full-throttle Acceleration from a stop	km/h	55–63	101–111	148–158	130–137
	mph	34–39	63–69	92–98	81–85

• **Downshift**

D

		LC.OFF	4th–3rd	3rd–2nd	2nd–1st
1/12 throttle Coasting or braking to a stop	km/h	21–24	—	29–35	6–11
	mph	13–15	—	18–22	4–7
7/16 throttle When car is slowed by increased grade, wind, etc.	km/h	74–80	—	—	—
	mph	46–50	—	—	—
Full-throttle When car is slowed by increased grade, wind, etc.	km/h	127–134	126–138	101–113	37–47
	mph	79–83	78–86	63–70	23–29

S (with S₄ switch in operation)

		LC.OFF	4th–3rd	3rd–2nd	2nd–1st
1/12 throttle Coasting or braking to a stop	km/h	35–39	—	29–35	6–11
	mph	22–24	—	18–22	4–7
7/16 throttle When car is slowed by increased grade, wind, etc.	km/h	84–92	—	—	—
	mph	52–57	—	—	—
Full-throttle When car is slowed by increased grade, wind, etc.	km/h	127–134	126–138	101–113	37–47
	mph	79–83	78–86	63–70	23–29

(cont'd)

Road Test

KX, KS, KZ, KQ models:
(PGM-FI)

• **Upshift**
D

		1st–2nd	2nd–3rd	3rd–4th	LC.ON
1/12 throttle Coasting down-hill from a stop	km/h	18–21	35–42	48–58	21–27
	mph	11–13	22–26	30–36	13–17
7/16 throttle Acceleration from a stop	km/h	27–34	53–63	87–97	97–103
	mph	17–21	33–39	54–60	60–64
Full-throttle Acceleration from a stop	km/h	55–63	106–116	143–153	134–140
	mph	34–39	66–72	89–95	83–87

S (with S4 switch in operation)

		1st–2nd	2nd–3rd	3rd–4th	LC.ON
1/12 throttle Coasting down-hill from a stop	km/h	18–21	37–43	58–68	35–42
	mph	11–13	23–27	36–42	22–26
7/16 throttle Acceleration from a stop	km/h	27–34	63–72	106–116	113–119
	mph	17–21	39–45	66–72	70–74
Full-throttle Acceleration from a stop	km/h	55–63	106–116	143–153	134–140
	mph	34–39	66–72	89–95	83–87

• **Downshift**

D

		LC.OFF	4th–3rd	3rd–2nd	2nd–1st
1/12 throttle Coasting or braking to a stop	km/h	21–24	—	29–35	10–14
	mph	13–15	—	18–22	6–9
7/16 throttle When car is slowed by increased grade, wind, etc.	km/h	77–84	—	—	—
	mph	48–52	—	—	—
Full-throttle When car is slowed by increased grade, wind, etc.	km/h	129–135	127–140	92–103	39–48
	mph	80–84	79–87	57–64	24–30

S (with S4 switch in operation)

		LC.OFF	4th–3rd	3rd–2nd	2nd–1st
1/12 throttle Coasting or braking to a stop	km/h	35–39	—	29–35	10–14
	mph	22–24	—	18–22	6–9
7/16 throttle When car is slowed by increased grade, wind, etc.	km/h	82–88	—	—	—
	mph	51–55	—	—	—
Full-throttle When car is slowed by increased grade, wind, etc.	km/h	129–135	127–140	92–103	39–48
	mph	80–84	79–87	57–64	24–30

CAUTION: Do not shift from **D** or **S** to **2** at speeds over 100 km/h (62.5 mph; you may damage the transmission.

2 (2nd Gear)

1. Accelerate from a stop at full throttle. Check that there is no abnormal noise or clutch slippage.
2. Upshifts and downshifts should not occur with the selector in this range.

R (Reverse)

Accelerate from a stop at full throttle, and check for abnormal noise and clutch slippage.

P (Park)

Park car on a slope (approx. 16°), apply the parking brake, and shift into Park. Release the brake; the car should not move.

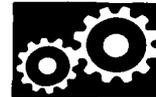

Stall Speed

Test

CAUTION:

- To prevent transmission damage, do not test stall speed for more than 10 seconds at a time.
- Do not shift the lever while rising the engine speed.
- Be sure to remove the pressure gauge before testing stall speed.

1. Engage parking brake and block the front wheels.
2. Connect safety chains to both front two hooks and attach, with minimum slack, to some strong stationary object.
3. Connect tachometer, and start the engine.
4. After the engine has warmed up to normal operating temperature, shift into **[2]**.
5. Fully depress the brake pedal and accelerator for 6 to 8 seconds, and note engine speed.
6. Allow 2 minutes for cooling, then repeat same test in **[D]**, and **[R]**.

Stall speed in **[D]**, **[2]** and **[R]** must be the same, and must also be within limits:

NOTE:

Stall speed test must be made only for checking the cause of trouble.

Stall Speed RPM:

(Carbureted Engine)

Standard: 2,700 min⁻¹ (rpm)

Service Limit: 2,550–2,850 min⁻¹ (rpm)

(Fuel Injected Engine)

Standard: 2,750 min⁻¹ (rpm)

Service Limit: 2,600–2,900 min⁻¹ (rpm)

TROUBLE	PROBABLE CAUSE
Stall rpm high in [D] , [2] & [R]	<ul style="list-style-type: none"> • Low fluid level or oil pump output. • Clogged oil strainer. • Pressure regulator valve stuck closed. • Slipping clutch.
Stall rpm high in [R]	<ul style="list-style-type: none"> • Slippage of 4th clutch
Stall rpm high in [2]	<ul style="list-style-type: none"> • Slippage of 2nd clutch
Stall rpm high in [D]	<ul style="list-style-type: none"> • Slippage of 1st clutch or 1st gear one-way clutch
Stall rpm low in [D] , [2] & [R]	<ul style="list-style-type: none"> • Engine output low • Torque converter one-way clutch slipping

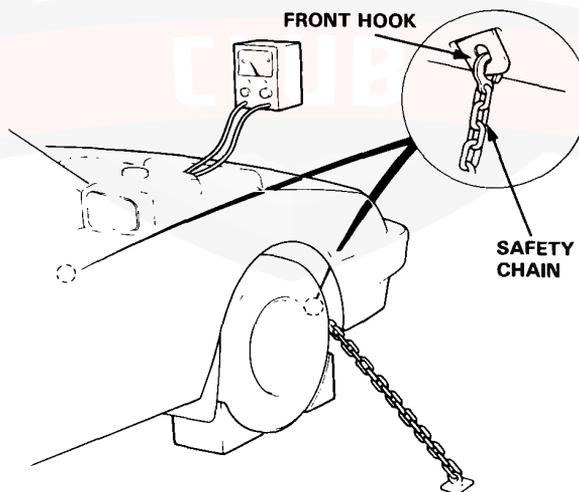

Pressure

Testing

CAUTION: Before testing, be sure transmission is filled to proper level.

NOTE:

- Stop engine when attaching hoses for pressure tests.
Torque hose fitting to 18 N·m (1.8 kg-m, 12 lb-ft).
- Do not reuse aluminum washers.

GAUGE SET 07406-0020003
(includes pressure hose set 07406-0020201)

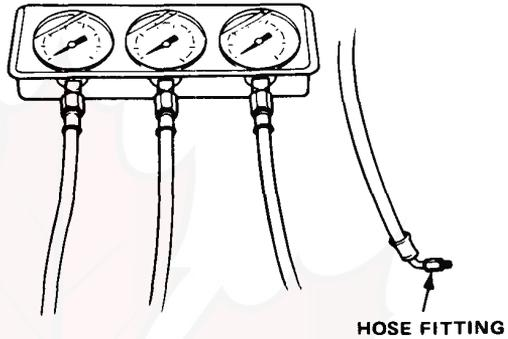

Line Pressure Measurement

- Set the parking brake securely.
- Run the engine at 2,000 min⁻¹ (rpm).

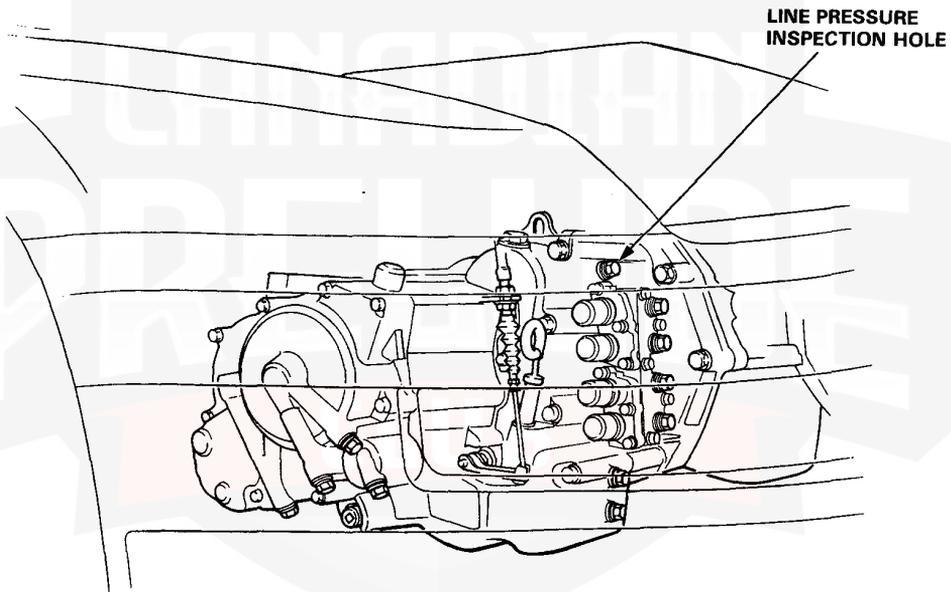

PRESSURE	SELECTOR POSITION	PROBABLE CAUSE	FLUID PRESSURE			
			FUEL-INJECTED ENGINE		CARBURETED ENGINE	
			Standard	Service limit	Standard	Service limit
Line	N or P	Torque converter, oil pump pressure regulator, torque converter check valve, oil pump	834–883 kPa (8.5–9.0 kg/cm ² , 121–128 psi)	785 kPa (8.0 kg/cm ² , 114 psi)	760–809 kPa (7.75–8.25 kg/cm ² , 110–117 psi)	711 kPa (7.25 kg/cm ² , 103 psi)



Clutch Pressure Measurement

- Set the parking brake securely and block the wheels.
- Jack up the front of the car and support it with a rigid rack.
- Run the engine at 2,000 min⁻¹ (rpm).

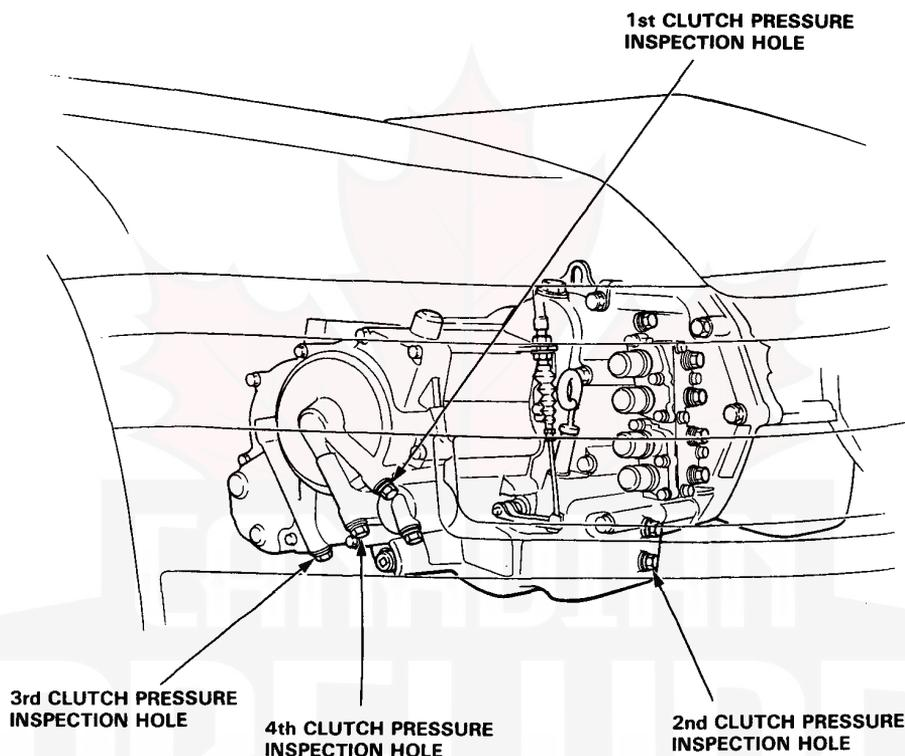

PRESSURE	SELECTOR POSITION	SYMPTOM	PROBABLE CAUSE	FLUID PRESSURE kPa (kg/cm ² , psi)			
				FUEL-INJECTED ENGINE		CARBURETED ENGINE	
				Standard	Service limit	Standard	Service limit
1st Clutch	S or D	No or low 1st pressure	1st Clutch	834–883 (8.5–9.0, 121–128)		760–809 (7.75–8.25, 110–117)	
2nd Clutch	2	No or low 2nd pressure	2nd Clutch				
2nd Clutch	S or D	No or low 2nd pressure	2nd Clutch	471 – 883 (4.8, 68) (9.0, 128)	422 (4.3, 61) with throttle lever closed. 785 (8.0, 114) with throttle lever in 3/8 opened or more.	471 – 809 (4.8, 68) (8.25, 117)	422 (4.3, 61) with throttle lever closed. 711 (7.25, 103) with throttle lever in 3/8 opened or more.
3rd Clutch	S or D	No or low 3rd pressure	3rd Clutch				
4th Clutch	S (with S4 switch in operation or D)	No or low 4th pressure	4th Clutch	Throttle control lever fully closed	Throttle control lever opened 3/8 or more	Throttle control lever fully closed	Throttle control lever opened or more
	R		Servo valve or 4th Clutch	834–883 (8.5–9.0, 121–128)	785 (8.0, 114)	760–809 (7.75–8.25, 110–117)	711 (7.25, 103)

(cont'd)

Pressure

Testing (cont'd)

Clutch Low/High Pressure Test

1. Raise the car and support with safety stands.
2. Attach the gauge set to the appropriate pressure test port.
3. Remove the cable end of the throttle control lever.

NOTE: Do not loosen the locknuts, simply unhook the cable end.

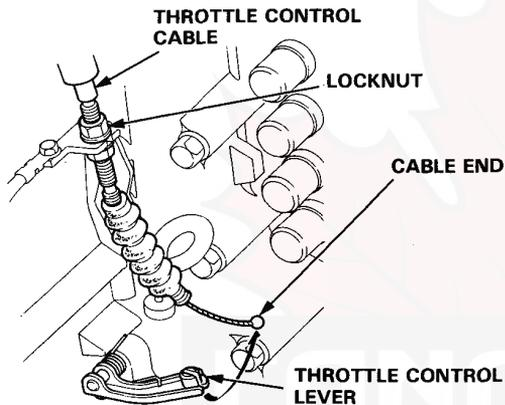

4. Warm up the engine to normal operating temperature (cooling fan comes on).
5. With the engine idling, move the selector lever to S or D.
6. Slowly move the throttle linkage to increase engine rpm until pressure is indicated on the appropriate gauge. Then release the throttle linkage, allowing the engine to return to an idle, and record the pressure reading.
7. Repeat step 6 for each clutch pressure being inspected.

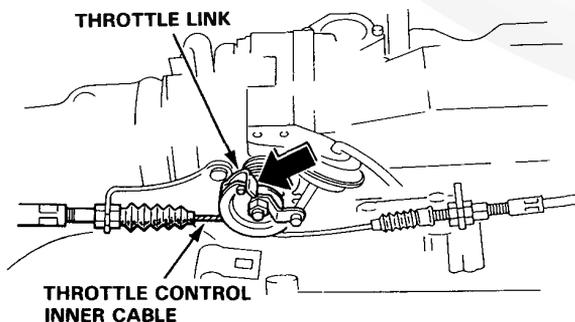

8. With the engine idling, lift the throttle control lever up approximately 1/2 of its possible travel and increase the engine rpm until pressure is indicated on the appropriate gauge. Record the highest pressure reading obtained.

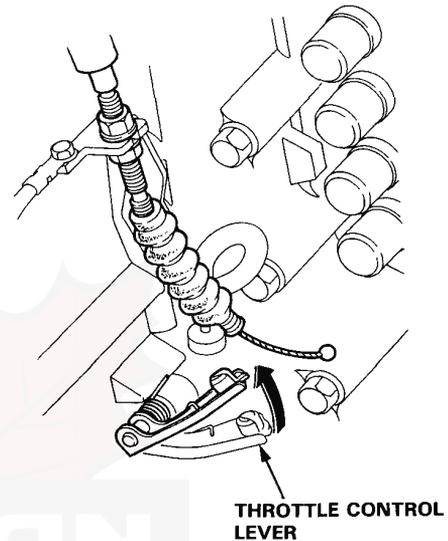

9. Repeat step 8 for each clutch pressure being inspected.

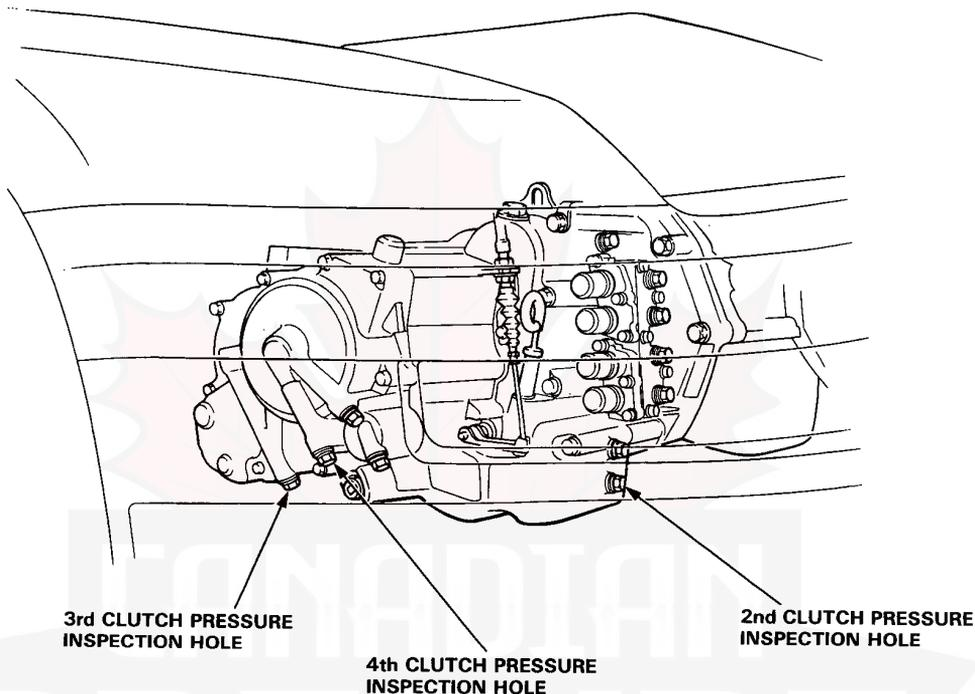
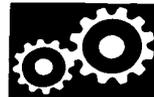

PRESSURE	SELECTOR POSITION	SYMPTOM	PROBABLE CAUSE	FLUID PRESSURE kPa (kg/cm ² , psi)			
				FUEL-INJECTED ENGINE		CARBURETED ENGINE	
				Standard	Service limit	Standard	Service limit
2nd Clutch	S or D	No or low 2nd pressure	2nd Clutch	471 — 883 (4.8, 68) — (9.0, 128)	422 (4.3, 61) with throttle lever released. 785 (8.0, 114) with throttle lever in 3/8 opened or more.	471 — 809 (4.8, 68) — (8.25, 117)	422 (4.3, 61) with throttle lever released. 711 (7.25, 103) with throttle lever in 3/8 opened or more
3rd Clutch	S or D	No or low 3rd pressure	3rd Clutch				
4th Clutch	D	No or low 4th pressure	4th Clutch				

(cont'd)

Pressure

Testing (cont'd)

Throttle B Pressure Measurement

- Set the parking brake securely and block the wheels.
- Run the engine at 1,000 min⁻¹ (rpm).
- Disconnect the throttle control cable from the throttle lever and set the control lever in full throttle position.

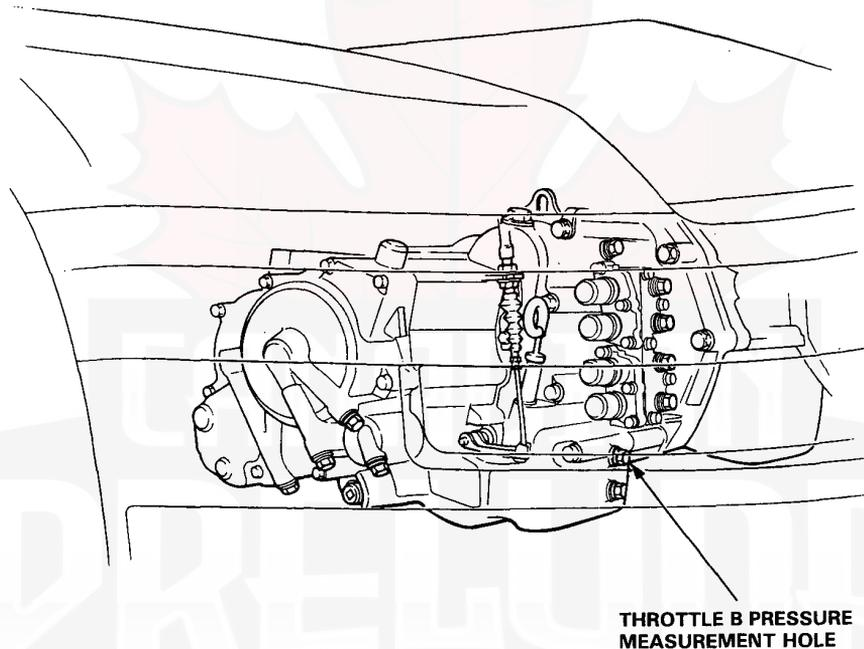

PRESSURE	SELECTOR POSITION	SYMPTOM	PROBABLE CAUSE	FLUID PRESSURE kPa (kg/cm ² , psi)			
				FUEL-INJECTED ENGINE		CARBURETED ENGINE	
				Standard	Service limit	Standard	Service limit
Throttle B	S or D	No (or low) Throttle B pressure	Throttle valve B	0 (close) 834–883 (8.5–9.0, 121–128) (fully opened) Enclosed in parentheses are throttle control lever opening angles.	— 785 (8.0, 114) (fully opened) Enclosed in parentheses are throttle control lever opening angles.	0 (close) 760–809 (7.75–8.25, 110–117) (fully opened) Enclosed in parentheses are throttle control lever opening angles.	— 711 (7.25, 103) (fully opened) Enclosed in parentheses are throttle control lever opening angles.

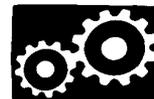

Modulator Pressure Measurement

- Set the parking brake securely and block the wheels.
- Start the engine and run in 2,000 min⁻¹ (rpm).
- Measure modulator pressure.

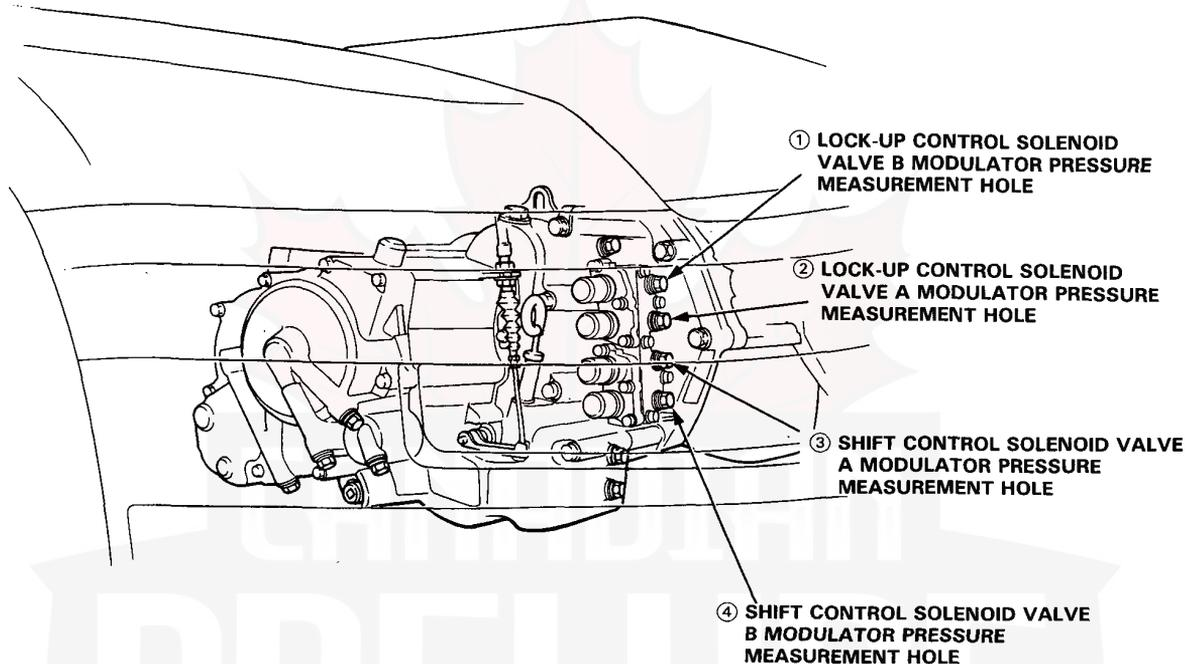

PRESSURE	SELECTOR POSITION	SYMPTOM	PROBABLE CAUSE	FLUID PRESSURE kPa (kg/cm ² , psi)	
				Standard	Service Limit
Modulator Pressure	N or P	No or low ① pressure	Lock-up Control Solenoid Valve B	471–510 (4.8–5.2, 68–74)	422 (4.3, 61)
		No or low ② pressure	Lock-up Control Solenoid Valve A		
		No or low ③ pressure	Shift Control Solenoid Valve A		
		No or low ④ pressure	Shift Control Solenoid Valve B		
		No or low All of ports pressure	Modulator Valve		
		High pressure	Modulator Valve		

Fluid Level

Checking/Changing

Checking

NOTE: Check fluid level after the engine has warmed up to normal operating temperature.

1. Park the car on level ground, stop the engine.
2. Remove the air-inlet.
3. Pull the transmission dipstick and check the level of fluid immediately after the engine is stopped within one minute.

NOTE: Transmission dipstick has yellow handle.

4. If the level is at, or below, the low mark, add DEXRON-II type automatic transmission fluid.

Changing

1. Bring the transmission up to operating temperature by driving the car. Park the car on level ground, turn the engine off, then remove drain plug.
2. Reinstall the drain plug with a new washer, then refill the transmission to the full mark on the dipstick.

Automatic transmission Fluid Capacity:

2.8 ℓ (3.0 U.S. qts. 2.5 Imp. qt) at change

6.2 ℓ (6.6 U.S. qts. 5.5 Imp. qt) after overhaul

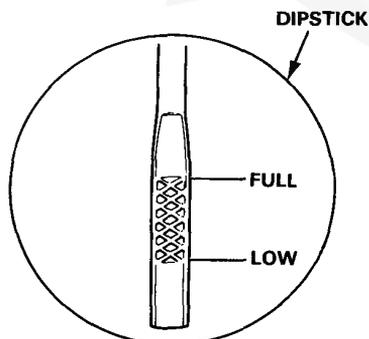
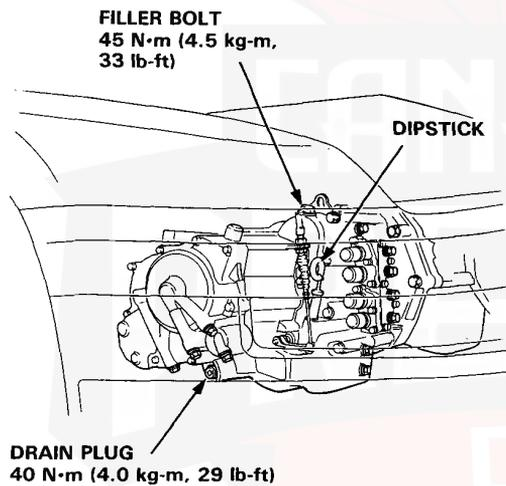

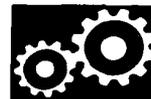

Transmission

Removal

1. Disconnect the ground cable at the battery and the transmission.
2. Disconnect the wiring for:
 - Starter motor
 - Lock-up control solenoids
 - Shift control solenoids
 - Speed pulser
3. Remove the air-inlet hose and the air cleaner case (PGM-FI only).
4. Remove the power steering speed sensor from the transmission without removing the power steering hoses.
5. Disconnect the throttle control cable at the transmission bracket.
6. Disconnect the oil cooler hoses at the joint pipes.

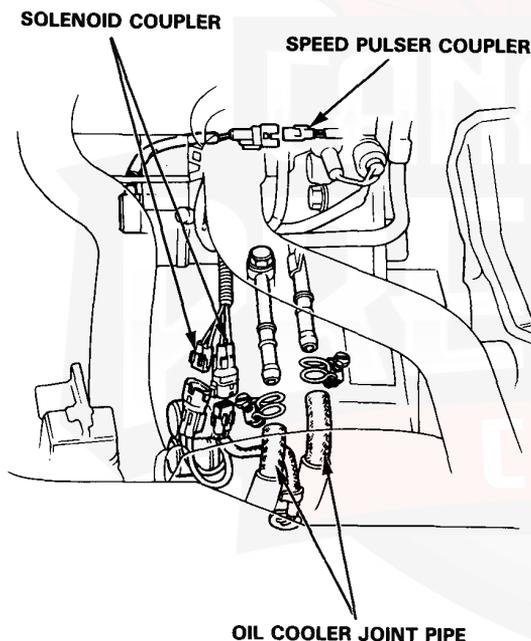

7. Remove the upper transmission mounting bracket.

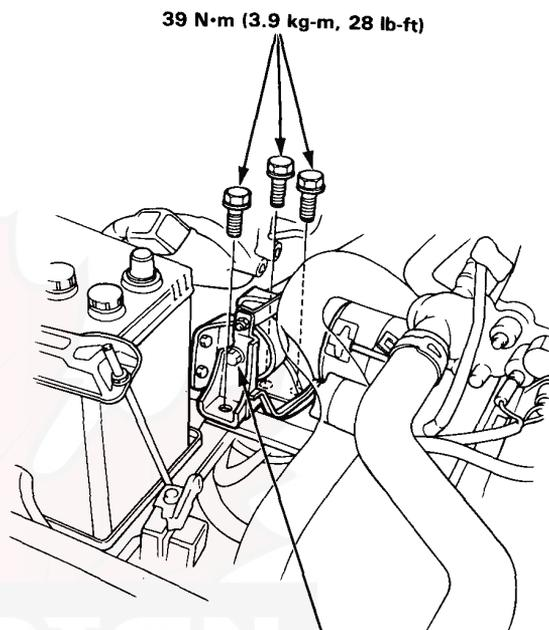

75 N·m (7.5 kg-m, 54 lb-ft)
Remove this bolt if required.

8. Remove the transmission and block attachment bolt that must be removed from the engine compartment.

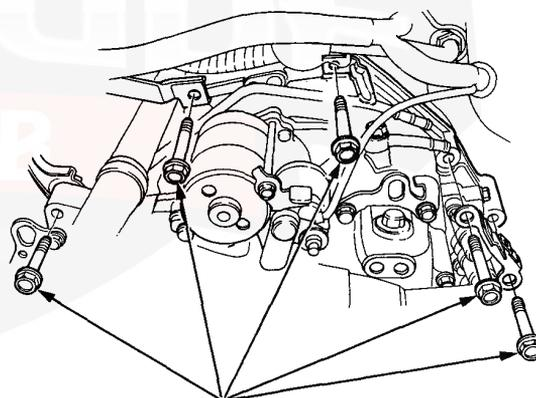

9. Raise vehicle at the reinforced lift points.
10. Remove both front wheels.

(cont'd)

Transmission

Removal (cont'd)

11. Remove the undercarriage splash shield.
12. Drain transmission oil.
13. Remove the center beam.

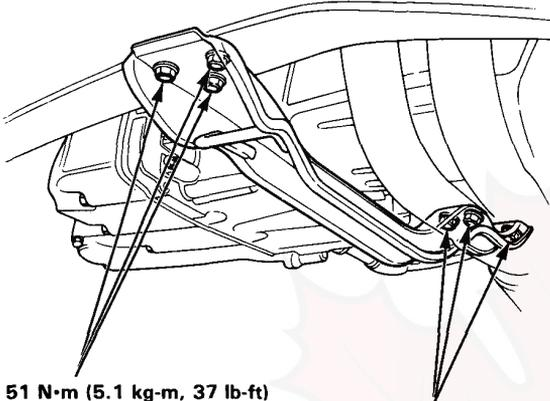

51 N·m (5.1 kg-m, 37 lb-ft)

51 N·m
(5.1 kg-m, 37 lb-ft)

14. Remove the right radius rod completely.
15. Remove the right and left drive shafts.
16. Remove the intermediate shaft.

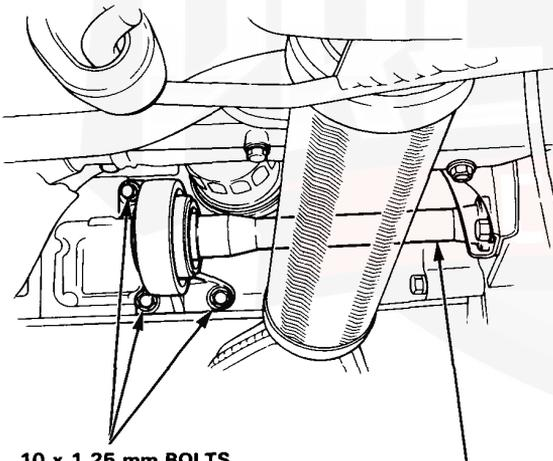

10 x 1.25 mm BOLTS
39 N·m (3.9 kg-m, 28 lb-ft)

INTERMEDIATE
SHAFT

17. Remove the engine stiffener.

39 N·m (3.9 kg-m, 28 lb-ft)

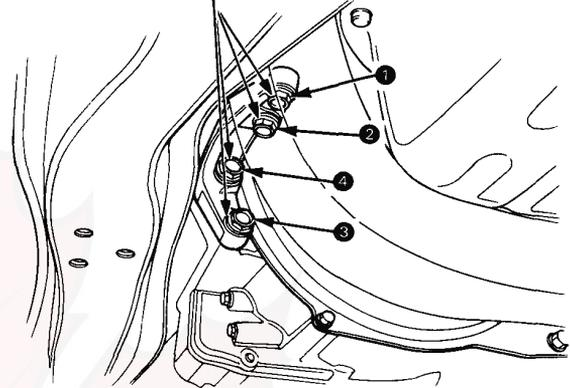

18. Remove the torque converter cover.

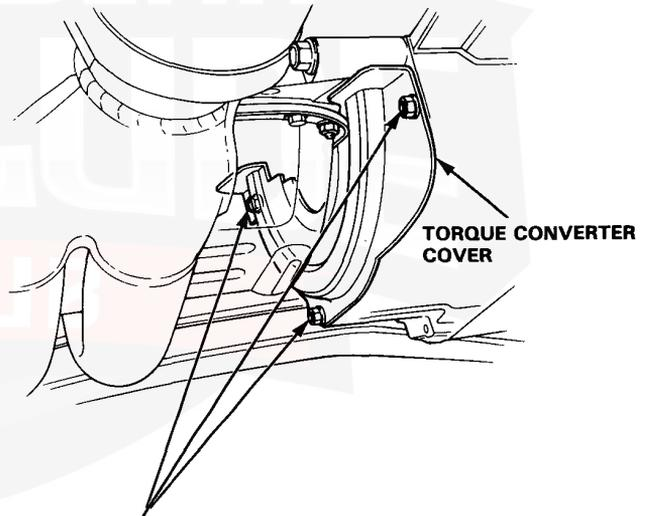

TORQUE CONVERTER
COVER

12 N·m (1.2 kg-m, 9 lb-ft)



19. Remove the shift cable from the transmission.

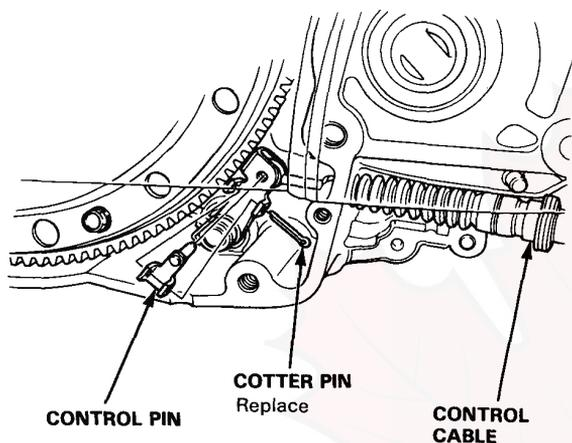

20. Remove the bolts from the drive plate.

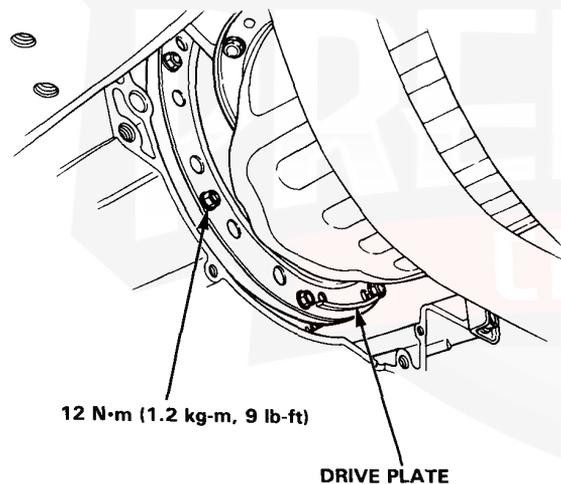

21. Support transmission with an appropriate jack.

22. Remove the lower bolt from the rear engine mounting bracket. Loosen but do not remove the top bolt. This bolt will support the weight of the engine.

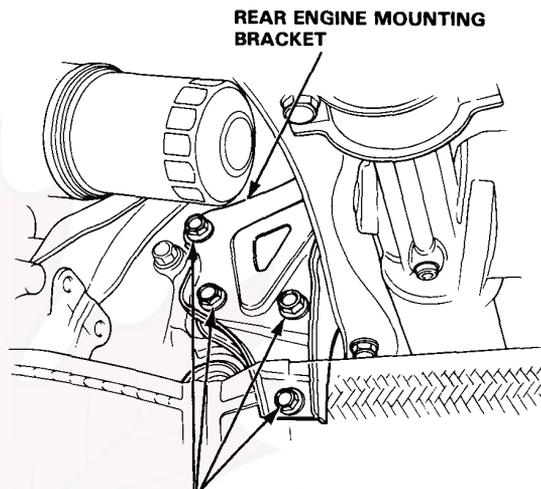

SPECIAL BOLTS
75 N·m (7.5 kg-m, 54 lb-ft)
Replace

23. Remove the remaining engine to transmission mounting bolts.

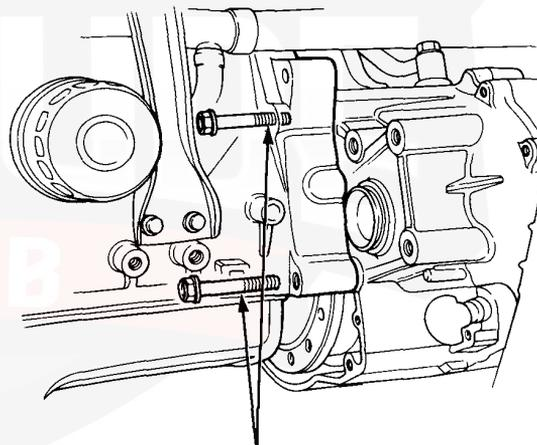

24. Place the transmission on an appropriate jack and separate the transmission from the engine block. Disengage the two 14 mm dowel pins and lower the transmission.

Illustrated Index

NOTE:

- Clean all parts thoroughly in solvent or carburetor cleaner, and dry with compressed air. Blow out all passages.
- Coat all parts with ATF before reassembly.

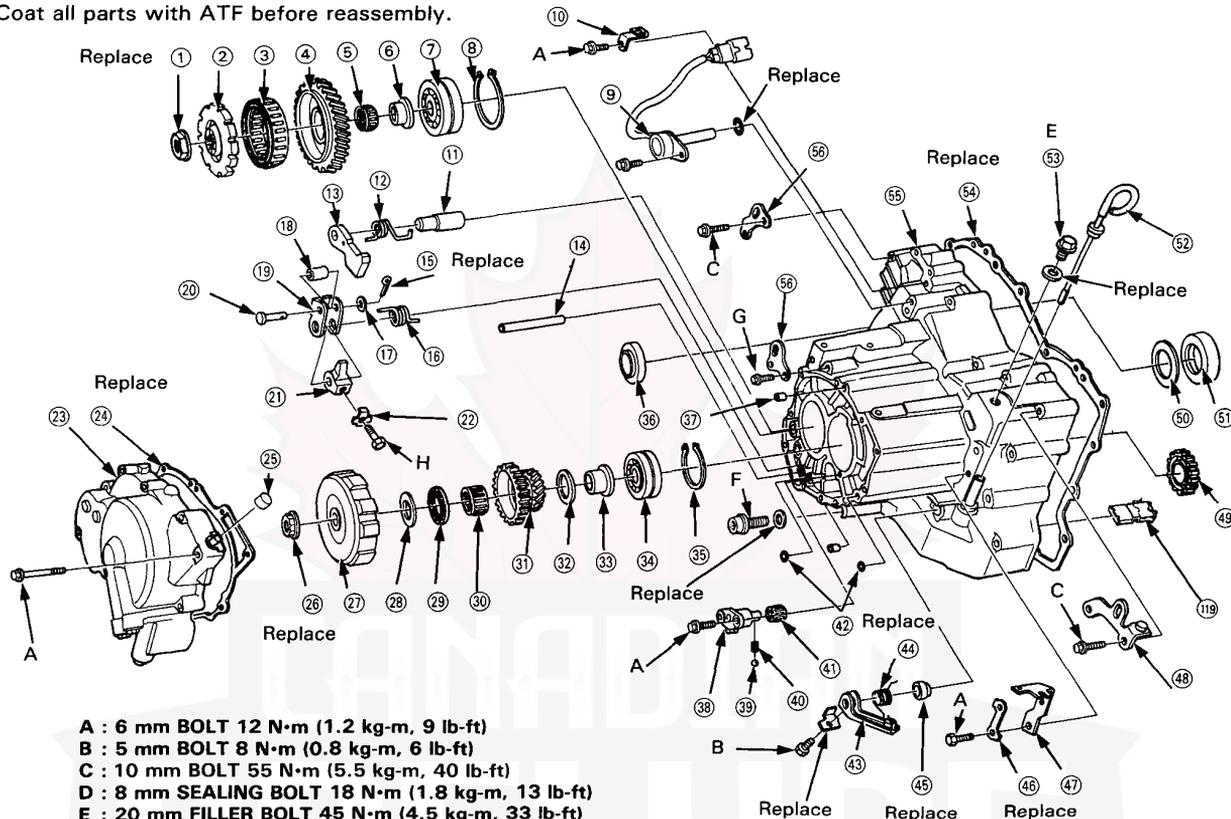

- A : 6 mm BOLT 12 N·m (1.2 kg-m, 9 lb-ft)
- B : 5 mm BOLT 8 N·m (0.8 kg-m, 6 lb-ft)
- C : 10 mm BOLT 55 N·m (5.5 kg-m, 40 lb-ft)
- D : 8 mm SEALING BOLT 18 N·m (1.8 kg-m, 13 lb-ft)
- E : 20 mm FILLER BOLT 45 N·m (4.5 kg-m, 33 lb-ft)
- F : 14 mm DRAIN PLUG 40 N·m (4.0 kg-m, 29 lb-ft)
- G : 8 mm BOLT 22 N·m (2.2 kg-m, 16 lb-ft)
- H : 6 mm BOLT 14 N·m (1.4 kg-m, 11 lb-ft)

- | | | | |
|---|---|---|--|
| <ul style="list-style-type: none"> ① LOCK NUT 23 mm
140 → 0 → 140 N·m
(14.0 → 0 → 14.0 kg-m,
102 → 0 → 102 lb-ft) ② PARKING GEAR
ONE-WAY CLUTCH ③ PARKING GEAR ④ 1st GEAR ⑤ NEEDLE BEARING
32 x 38 x 14 mm ⑥ 1st GEAR COLLAR ⑦ BALL BEARING
26 x 68 x 18 mm ⑧ SNAP RING 68 mm ⑨ SPEED PULSER ⑩ SPEED PULSER COUPLER
STAY ⑪ PARKING PAWL SHAFT ⑫ PARKING PAWL SPRING ⑬ PARKING PAWL | <ul style="list-style-type: none"> ⑭ STOP PIN ⑮ COTTER PIN 1.6 mm ⑯ PARKING PAWL SPRING ⑰ WASHER 6 mm ⑱ PARKING BRAKE ROLLER ⑲ PARKING SHIFT ARM
ROLLER PIN ⑳ PARKING BRAKE
STOPPER ㉑ LOCK WASHER ㉒ R. SIDE COVER ㉓ GASKET ㉔ BREATHER CAP ㉕ LOCK NUT 19 mm
95 → 0 → 95 N·m (9.5
→ 0 → 9.5 kg-m, 69 → 0
→ 69 lb-ft) ㉖ 1st CLUTCH ASSEMBLY | <ul style="list-style-type: none"> ㉗ THRUST WASHER 26 mm ㉘ THRUST NEEDLE
BEARING
31 x 47 x 2 mm ㉙ NEEDLE BEARING
31 x 36 x 18.5 mm ㉚ 1st GEAR ㉛ THRUST WASHER
31 x 42 x 1.5 mm ㉜ COLLAR 26 mm ㉝ BALL BEARING
26 x 75 x 19 mm ㉞ SNAP RING 75 mm ㉟ OIL SEAL ㊱ DOWEL PIN 8 x 14 mm ㊲ REVERSE IDLER GEAR
HOLDER ㊳ STEEL BALL ㊴ IDLER SPRING ㊵ NEEDLE BEARING
14 x 18 x 15 mm ㊶ O-RING 7.7 x 2.3 mm ㊷ THROTTLE CONTROL
LEVER | <ul style="list-style-type: none"> ㊸ THROTTLE CONTROL
SHAFT SPRING ㊹ OIL SEAL ㊺ LOCK PLATE ㊻ THROTTLE CABLE STAY ㊼ TRANSMISSION
HANGER ㊽ REVERSE IDLER GEAR ㊾ DIFFERENTIAL THRUST
SHIM ㊿ BEARING OUTER RACE 1 BEARING OUTER RACE
DIPSTICK 2 FILLER BOLT 3 GASKET 4 TRANSMISSION
HOUSING 5 TRANSMISSION
HANGER |
|---|---|---|--|

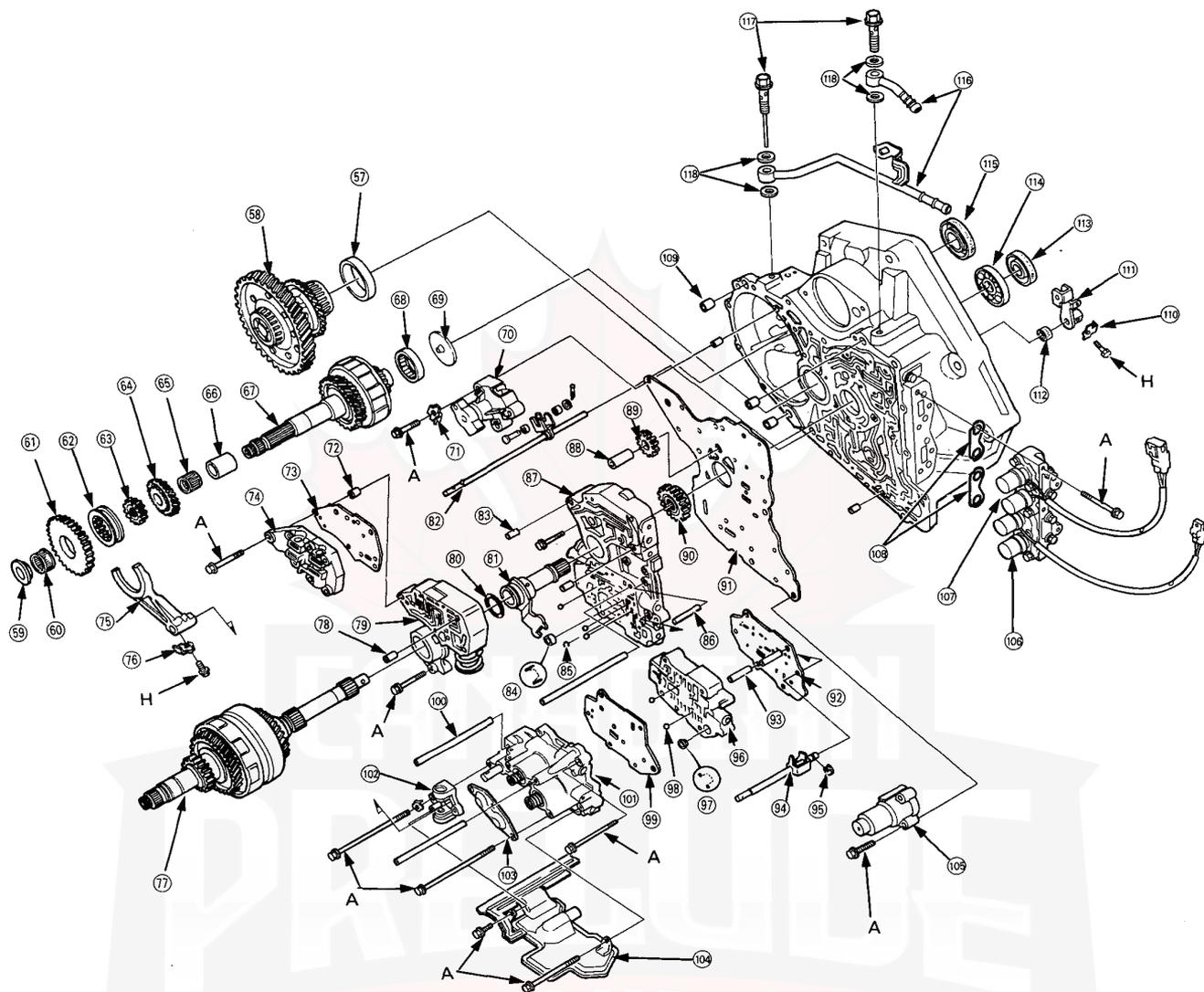

- 57 BEARING OUTER RACE
- 58 DIFFERENTIAL ASSEMBLY
- 59 COUNTERSHAFT 1ST GEAR COLLAR
- 60 NEEDLE BEARING
- 61 COUNTERSHAFT REVERSE GEAR
- 62 REVERSE GEAR SELECTOR
- 63 REVERSE SELECTOR HUB
- 64 COUNTERSHAFT 4TH GEAR
- 65 NEEDLE BEARING
- 66 DISTANCE COLLAR
- 67 COUNTERSHAFT
- 68 NEEDLE BEARING
- 69 OIL GUIDE PLATE Replace
- 70 ATV PULSER ROTOR
- 71 LOCK PLATE Replace
- 72 DOWEL PIN
- 73 LOCK-UP BODY SEPARATOR PLATE
- 74 LOCK-UP BODY
- 75 REVERSE SHIFT FORK
- 76 LOCK PLATE Replace
- 77 MAINSHAFT
- 78 DOWEL PIN

- 79 REGULATOR VALVE BODY
- 80 O-RING Replace
- 81 STATOR SHAFT
- 82 CONTROL SHAFT
- 83 DOWEL PIN
- 84 FILTER Replace
- 85 CHECK BALL
- 86 STOP PIN
- 87 MAIN VALVE BODY
- 88 OIL PUMP DRIVEN GEAR SHAFT
- 89 OIL PUMP DRIVEN GEAR
- 90 OIL PUMP DRIVE GEAR
- 91 MAIN SEPARATOR PLATE
- 92 SECONDARY SEPARATOR PLATE
- 93 DOWEL PIN
- 94 THROTTLE CONTROL SHAFT
- 95 E-RING
- 96 SECONDARY VALVE BODY
- 97 FILTER Replace
- 98 CHECK BALL
- 99 SERVO SEPARATOR PLATE
- 100 CLUTCH FEED PIPE

- 101 SERVO VALVE BODY
- 102 SERVO DETENT BASE
- 103 ACCUMULATOR COVER
- 104 ATF STRAINER
- 105 2ND ACCUMULATOR BODY
- 106 SHIFT CONTROL SOLENOID VALVE ASSEMBLY
- 107 LOCK-UP CONTROL SOLENOID VALVE ASSEMBLY
- 108 BASE GASKET Replace
- 109 DOWEL PIN
- 110 LOCK PLATE Replace
- 111 CONTROL SHAFT LEVER
- 112 OIL SEAL Replace
- 113 OIL SEAL Replace
- 114 MAINSHAFT BALL BEARING Replace
- 115 DIFFERENTIAL OIL SEAL Replace
- 116 ATF COOLER PIPE
- 117 JOINT BOLT
- 118 SEALING WASHER Replace
- 119 ATF MAGNET

Transmission Housing/Valve Body

Removal

NOTE:

- Clean all parts thoroughly in solvent or carburetor cleaner and dry with compressed air.
- Blow out all passages.
- Mainshaft locknut has left hand thread.

1. Remove the transmission housing and valve body in the following numbered sequence.

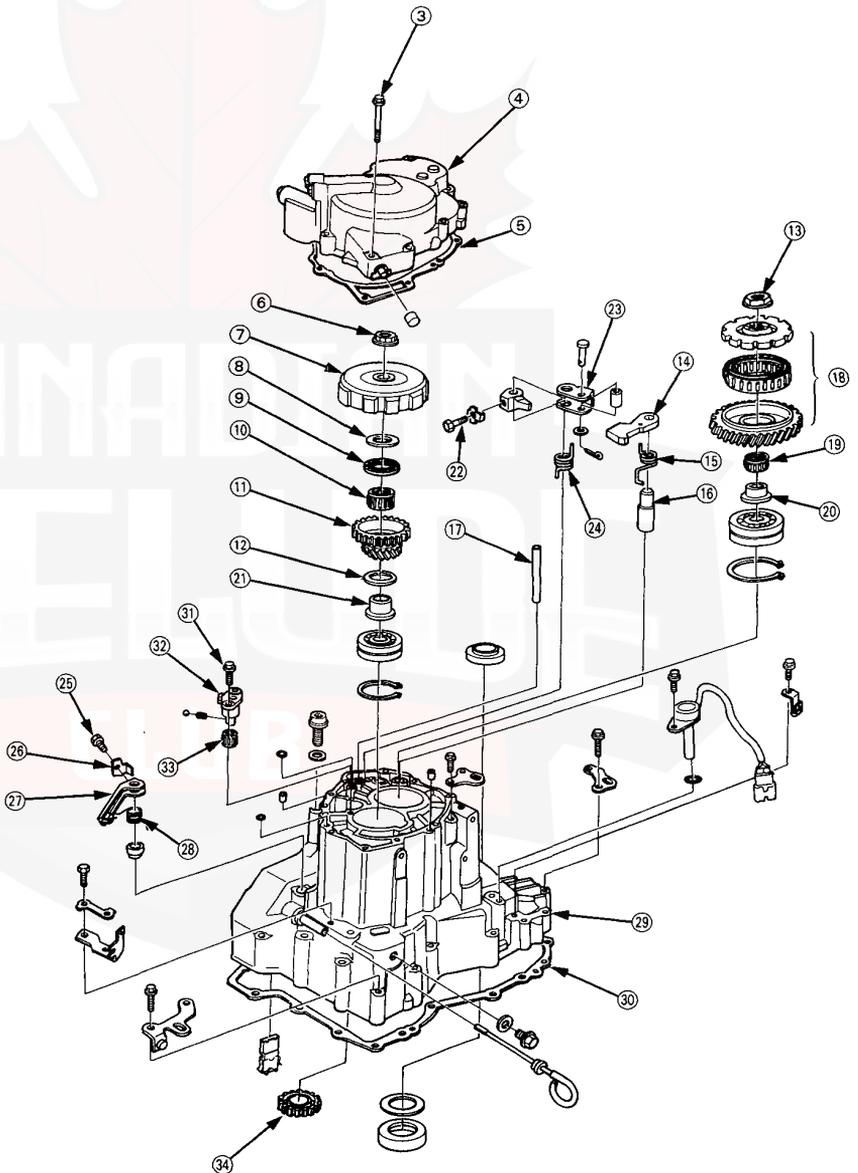
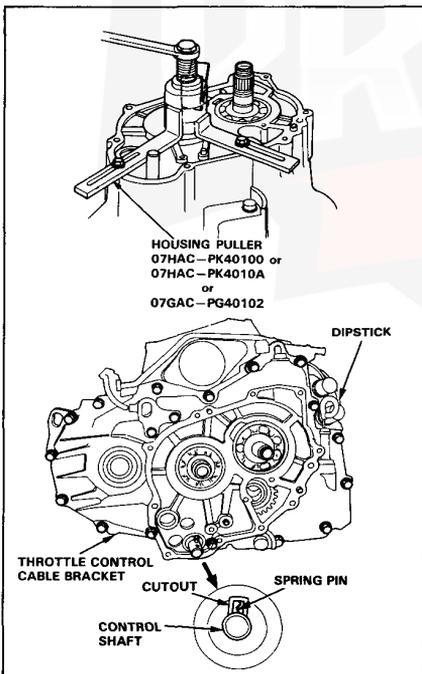
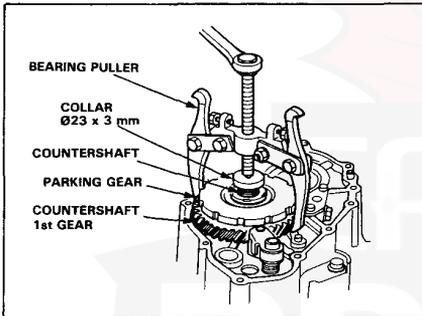
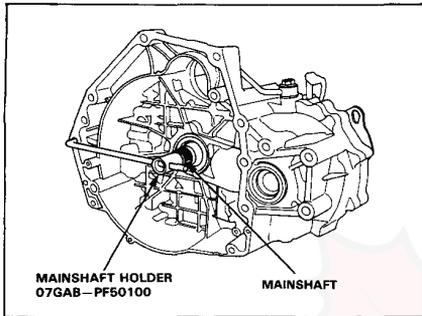

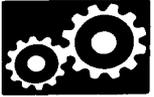

NOTE: Remove the mainshaft and countershaft together.

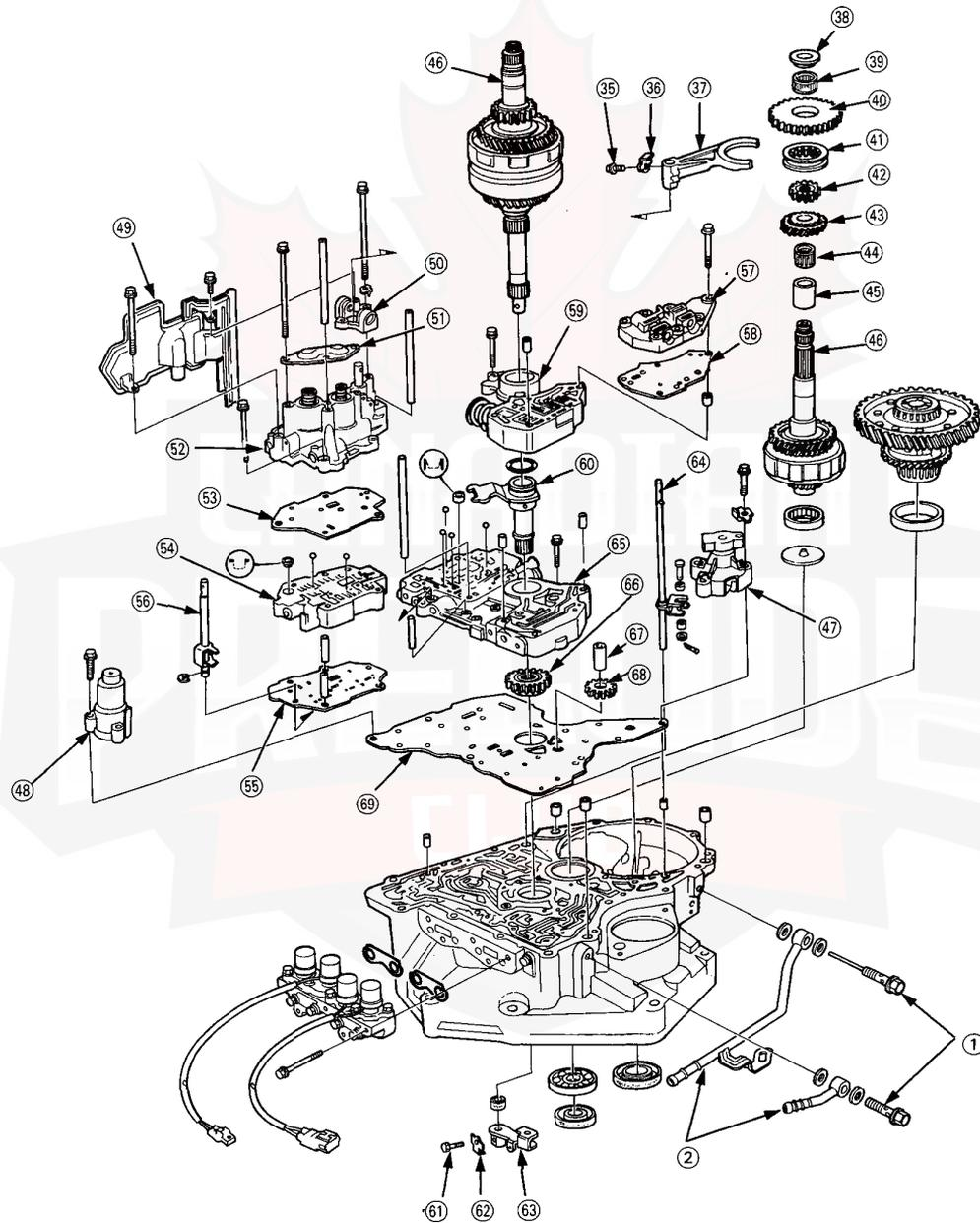

Valve

Assembly

NOTE: Coat all parts with ATF before assembly.

1. Install the valve, valve spring and cap in the valve body and secure with the roller.

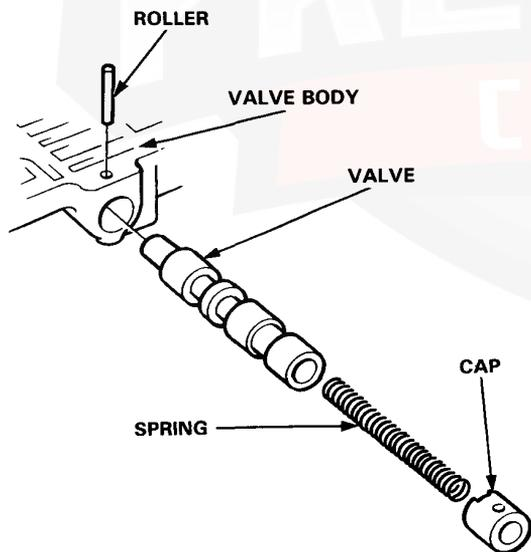
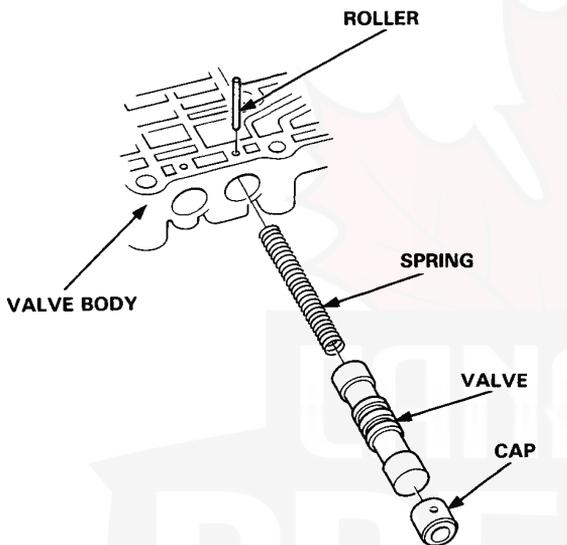

2. Set the spring in the valve and install it in the valve body. Push the spring in with a screwdriver then install the spring seat.

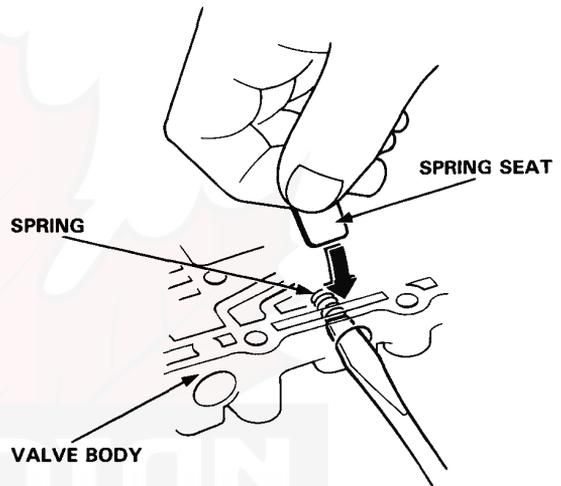

3. Install the manual valve, roller and roller spring in the main valve body.

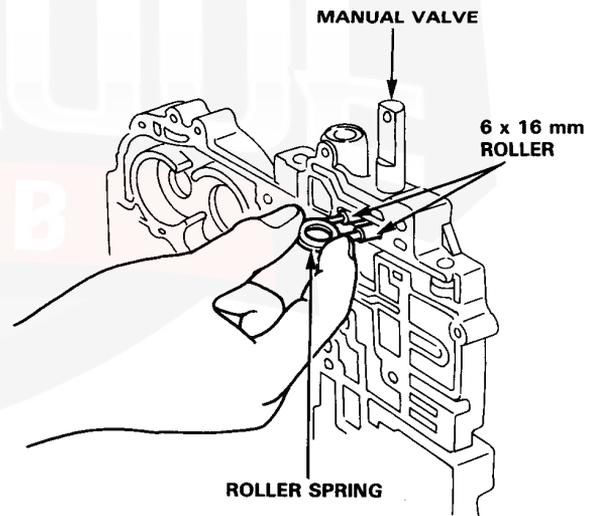

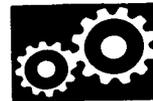

Main Valve Body

Disassembly/Inspection/Reassembly

NOTE:

- Clean all parts thoroughly in solvent or carburetor cleaner and dry with compressed air.
- Blow out all passages.
- Check all valves for free movement, if any fail to slide freely, see Valve Body Repair.
- Coat all parts with ATF before reassembly.

CAUTION: Do not use a magnet to remove the check balls; it may magnetize the balls.

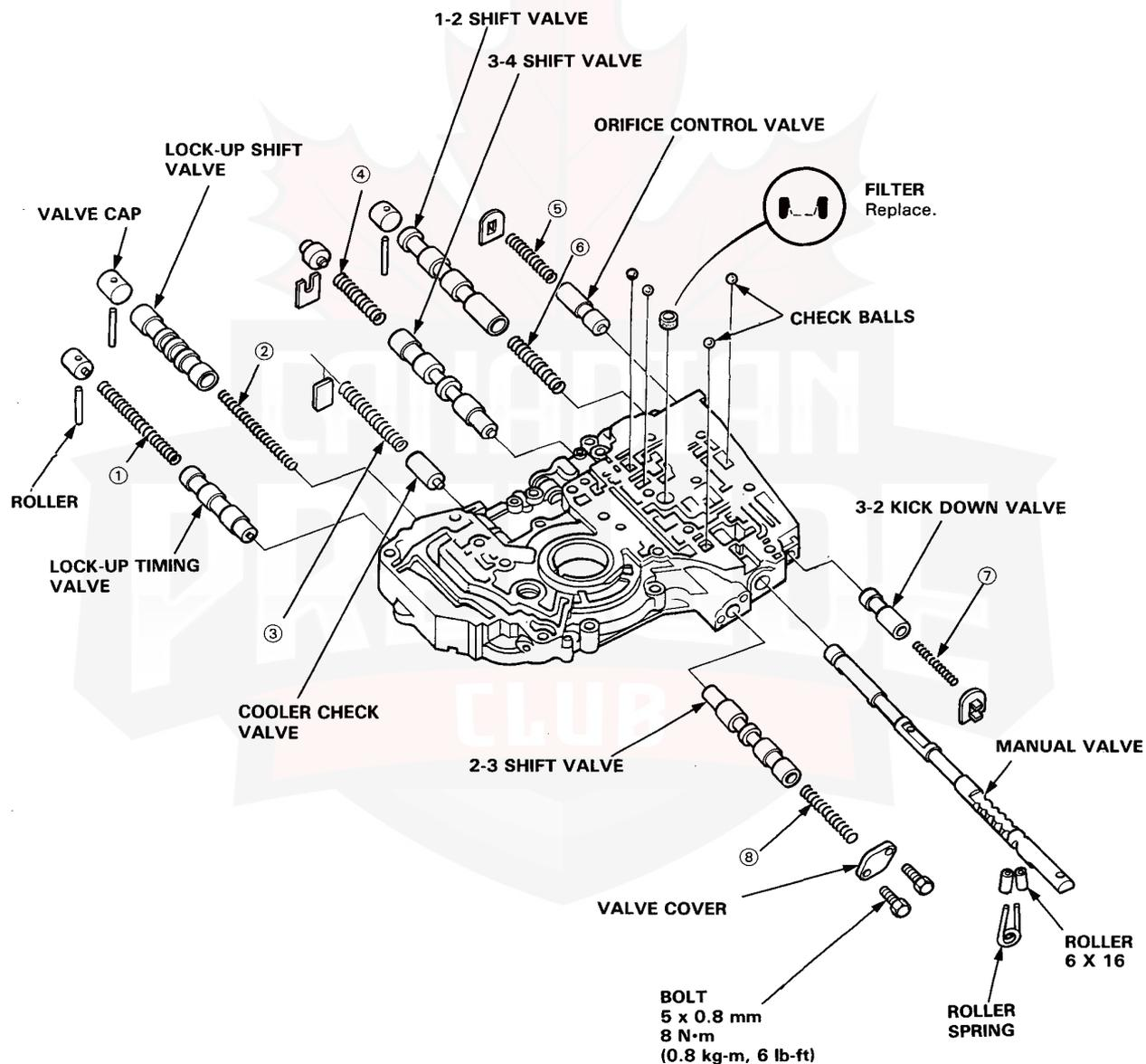

(cont'd)

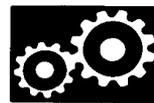

Regulator Valve Body

Disassembly/Inspection/Reassembly

NOTE:

- Clean all parts thoroughly in solvent or carburetor cleaner and dry with compressed air.
- Blow out all passages.
- Check all valves for free movement, if any fail to slide freely, see Valve Body Repair.

1. Hold the regulator spring cap in place while removing the stopper bolt. Once the bolt is removed, release the spring cap slowly.

CAUTION: The regulator spring cap can pop out when the stopper bolt is removed.

2. Reassembly is in the reverse order of disassembly.

NOTE:

- Coat all parts with ATF.
- Align the hole in the regulator spring cap with the hole in the valve body, then press the spring cap into the valve body and tighten the stopper bolt.

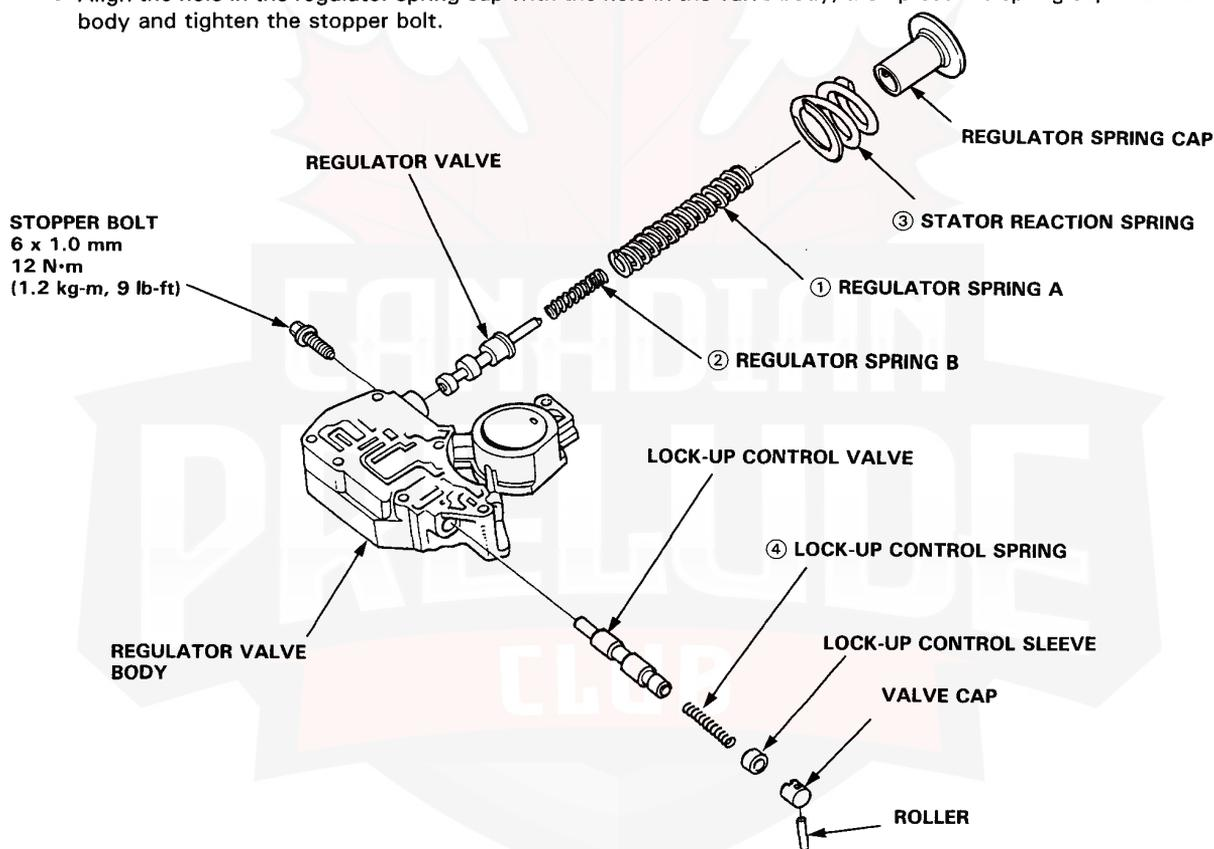

Spring Specifications

Ref. No.	Spring	Standard				
		Wire Dia. mm (in)	O.D. mm (in)	Free Length mm (in)	No. of Coils	
①	Regulator valve	Carbureted engine	1.8 (0.071)	14.7 (0.579)	85.1 (3.350)	16.5
		Fuel-Injected engine	1.8 (0.071)	14.7 (0.579)	88.6 (3.488)	16.5
②	Regulator valve spring B		1.8 (0.071)	9.6 (0.378)	44.0 (1.732)	7.5
③	Stator reaction spring		6.0 (0.236)	38.4 (1.512)	30.3 (1.193)	2
④	Lock-up control spring		0.7 (0.028)	6.6 (0.260)	38.0 (1.496)	14.1

Secondary Valve Body

Disassembly/Inspection/Reassembly

NOTE:

- Clean all parts thoroughly in solvent or carburetor cleaner and dry with compressed air.
- Blow out all passages.
- Check all valves for free movement, if any fail to slide freely, see Valve Body Repair.
- Coat all parts with ATF before reassembly.

CAUTION: Do not use a magnet to remove the check balls; it may magnetize the balls.

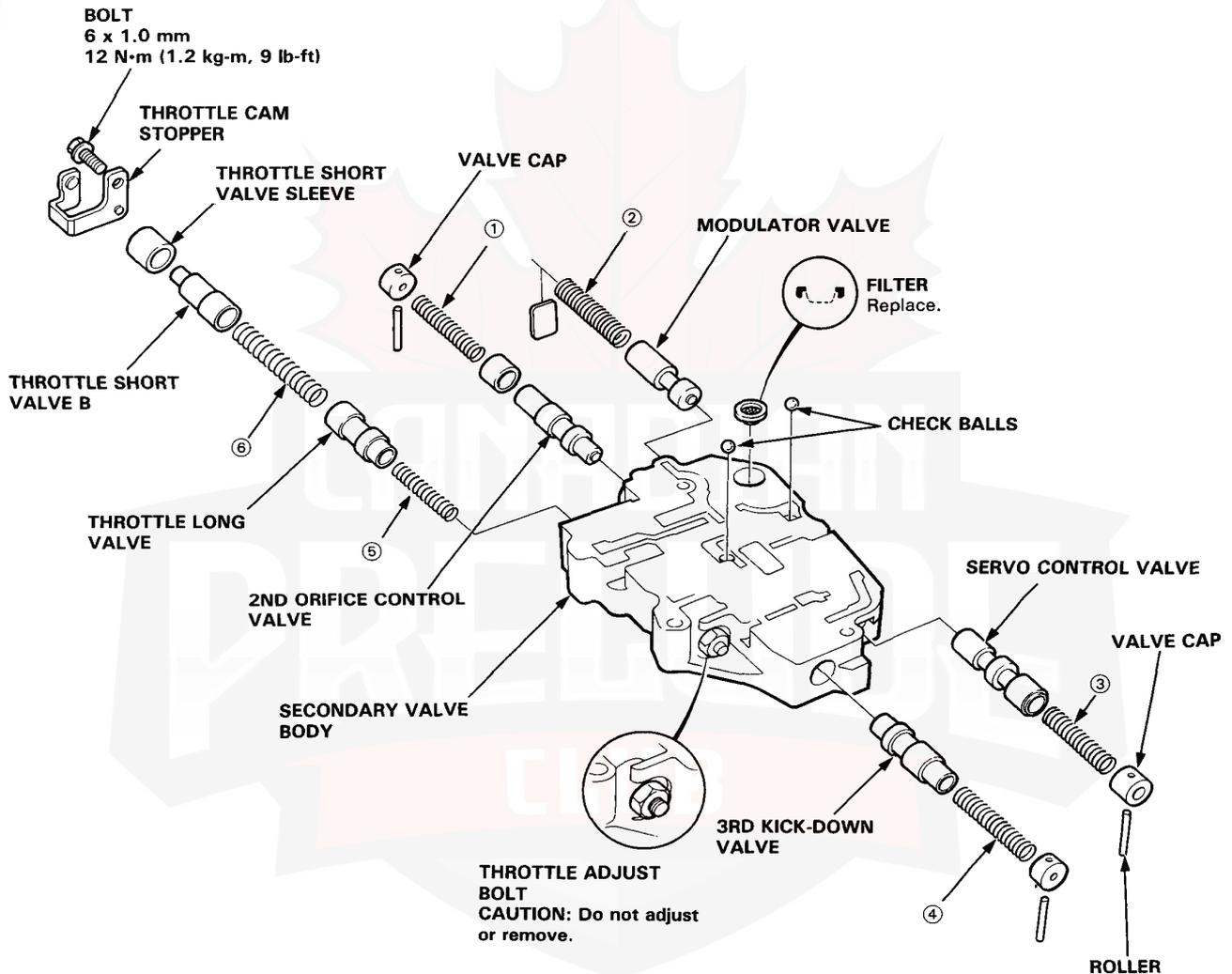

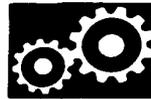

Spring Specifications

Ref. No.	Spring	Standard			
		Wire Dia. mm (in)	O.D. mm (in)	Free Length mm (in)	No. of Coils
①	2nd orifice control spring	0.8 (0.031)	6.6 (0.260)	46.9 (1.846)	35.1
②	Modulator valve spring	1.4 (0.055)	9.4 (0.370)	32.4 (1.276)	10.5
③	Servo control spring	1.0 (0.039)	8.1 (0.319)	42.0 (1.654)	16.5
④	3rd kick-down spring	0.9 (0.035)	6.6 (0.260)	63.5 (2.500)	31.1
⑤	Throttle valve adjust spring	0.8 (0.031)	6.5 (0.256)	30.0 (1.181)	8
⑥	Throttle B spring	1.4 (0.055)	8.5 (0.335)	41.4 (1.630)	8.4
		1.4 (0.055)	8.5 (0.335)	41.4 (1.630)	7.8
		1.6 (0.063)	8.5 (0.335)	41.3 (1.626)	13.9

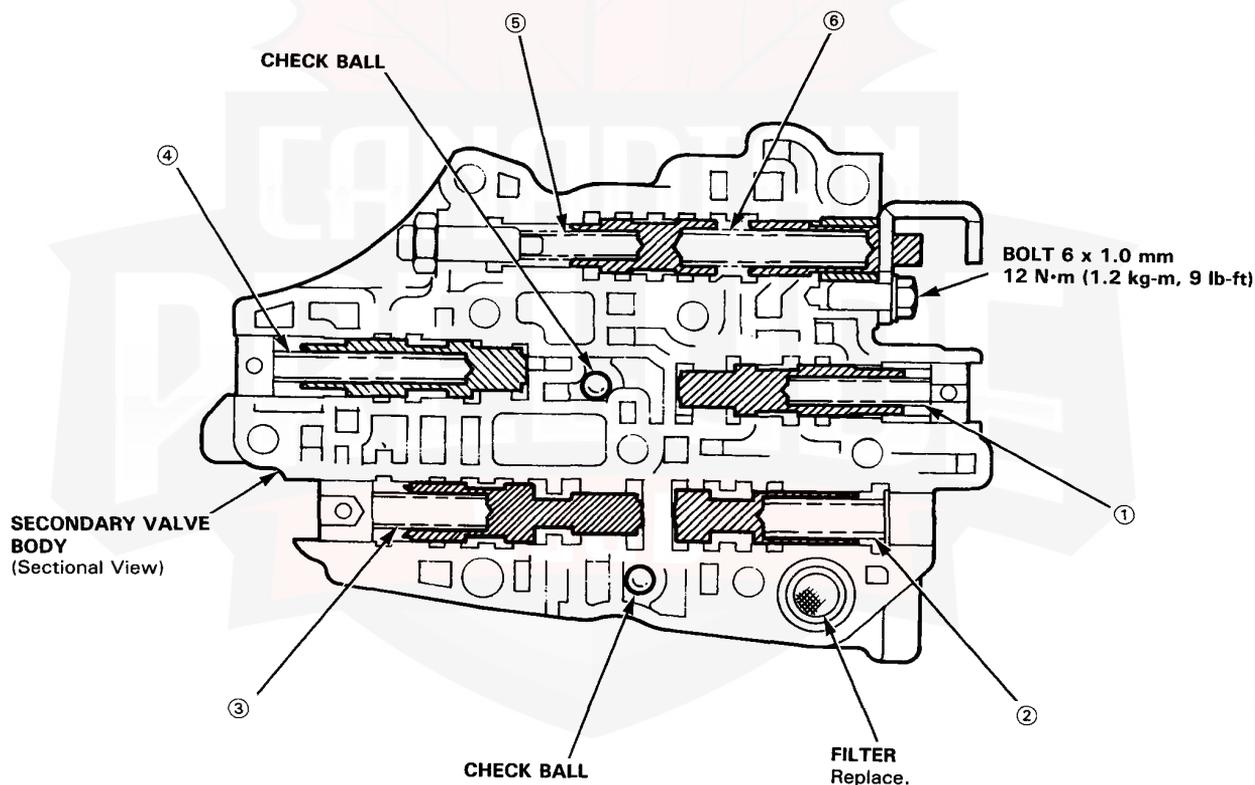

Servo Valve Body

Disassembly/Inspection/Reassembly

NOTE:

- Clean all parts thoroughly in solvent or carburetor cleaner and dry with compressed air.
- Blow out all passages.
- Check all valves for free movement, if any fail to slide freely, see Valve Body Repair.
- Coat all parts with ATF before reassembly.

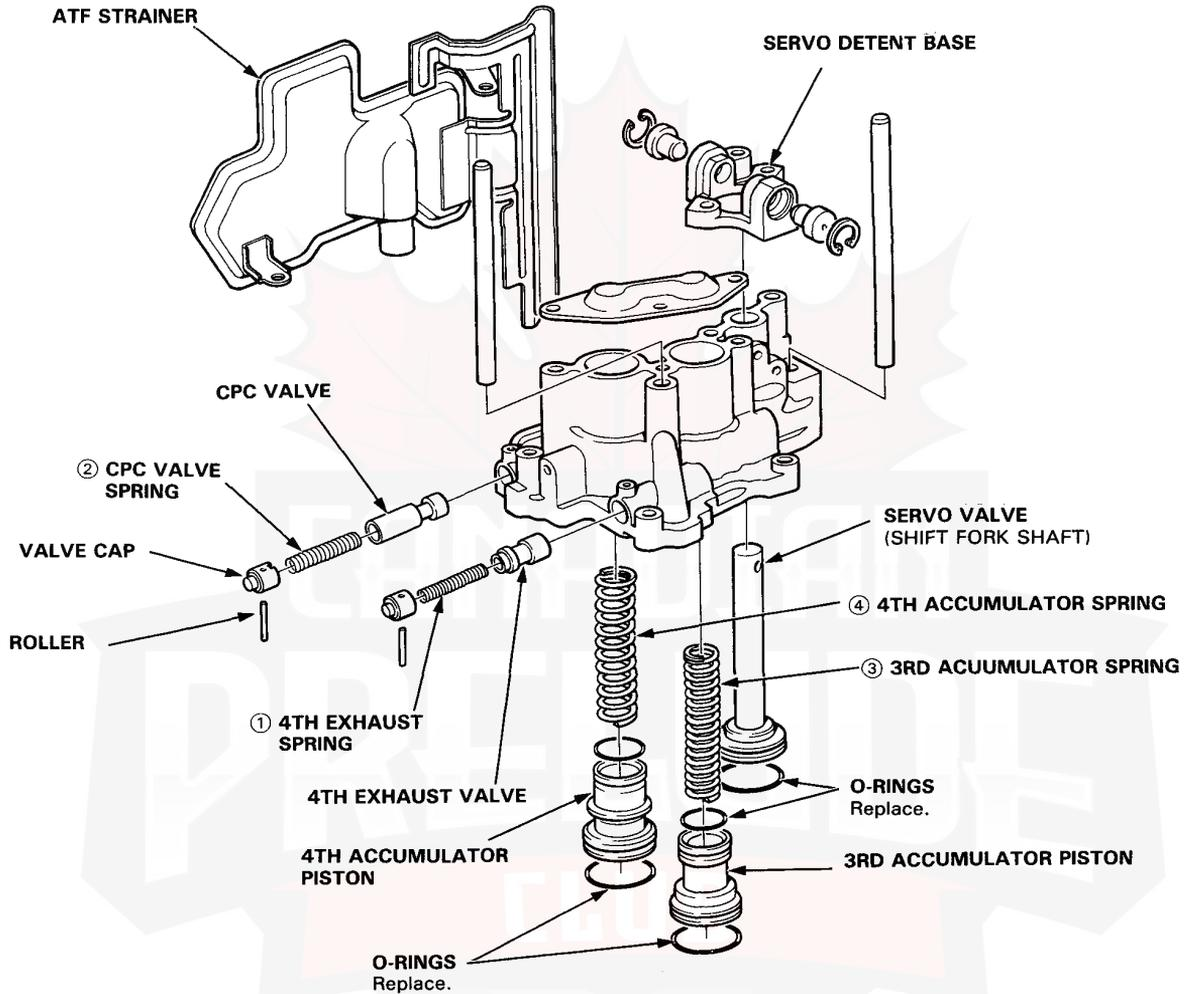

Spring Specifications

Ref. No.	Spring	Standard			
		Wire Dia. mm (in)	O.D. mm (in)	Free Length mm (in)	No. of Coils
①	4th exhaust spring	0.9 (0.035)	5.6 (0.220)	34.1 (1.343)	19.3
②	CPC valve spring	1.4 (0.055)	9.4 (0.370)	36.6 (1.441)	12.6
③	3rd accumulator spring	2.7 (0.106)	16.0 (0.630)	75.9 (2.988)	13.2
④	4th accumulator spring	3.2 (0.126)	18.6 (0.732)	79.0 (3.110)	13.2

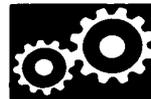

Lock-Up Body

Disassembly/Inspection/Reassembly

NOTE:

- Clean all parts thoroughly in solvent or carburetor cleaner and dry with compressed air.
- Blow out all passages.
- Check all valves for free movement, if any fail to slide freely, see Valve Body Repair.
- Coat all parts with ATF before reassembly.

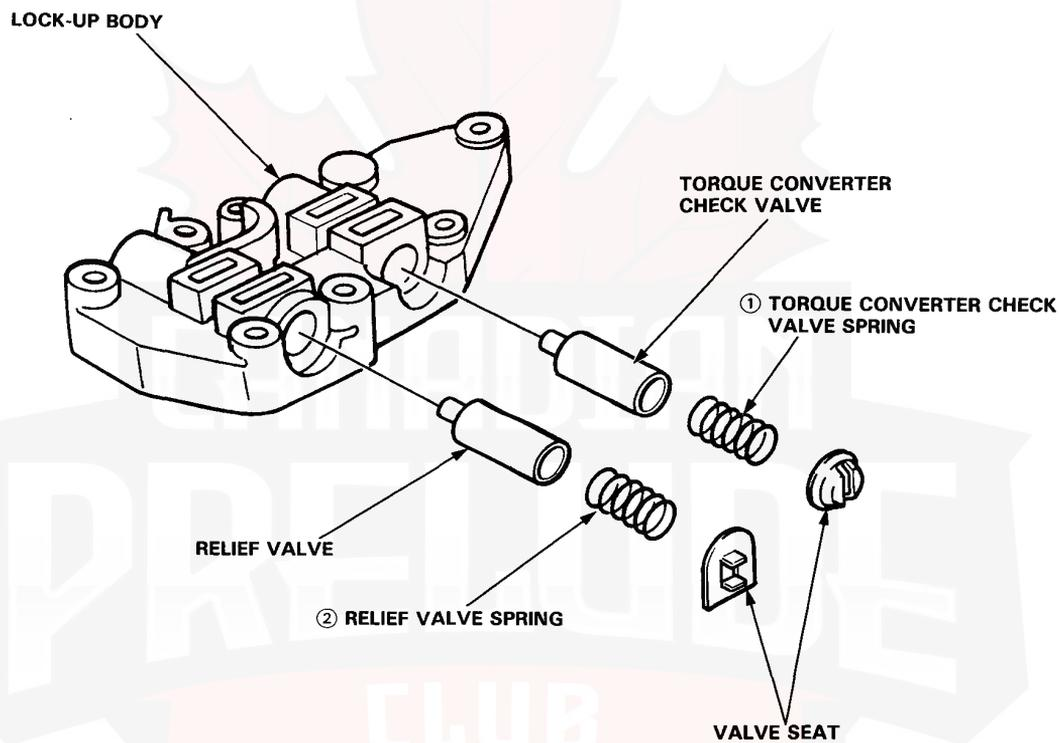

Spring Specifications

Ref. No.	Spring	Standard			
		Wire Dia. mm (in)	O.D. mm (in)	Free Length mm (in)	No. of Coils
①	Torque converter check valve spring	1.1 (0.043)	8.4 (0.331)	36.3 (1.429)	12.5
②	Relief valve spring	0.9 (0.035)	8.4 (0.331)	57.8 (2.276)	20.2

2nd Accumulator Body

Disassembly/Inspection/ Reassembly

NOTE:

- Clean all parts thoroughly in solvent or carburetor cleaner and dry with compressed air.
- Blow out all passages.
- Coat all parts with ATF before reassembly.

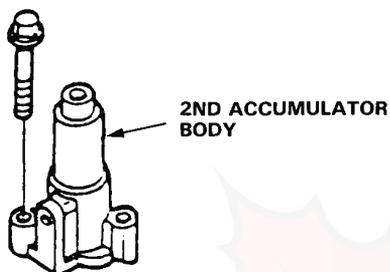

2ND ACCUMULATOR
BODY



2ND ACCUMULATOR
SPRING



O-RING
Replace.



2ND ACCUMULATOR
PISTON



O-RING
Replace.

SPRING SPECIFICATION

2nd accumulator spring		
Wire Dia.	mm (in)	2.8 (0.110)
O.D.	mm (in)	16.5 (0.650)
Free Length	mm (in)	85.0 (3.346)
No. of Coils		15.3

ATV Pulser Rotor

Disassembly/Inspection/ Reassembly

NOTE: Clean all parts with solvent and dry with compressed air.

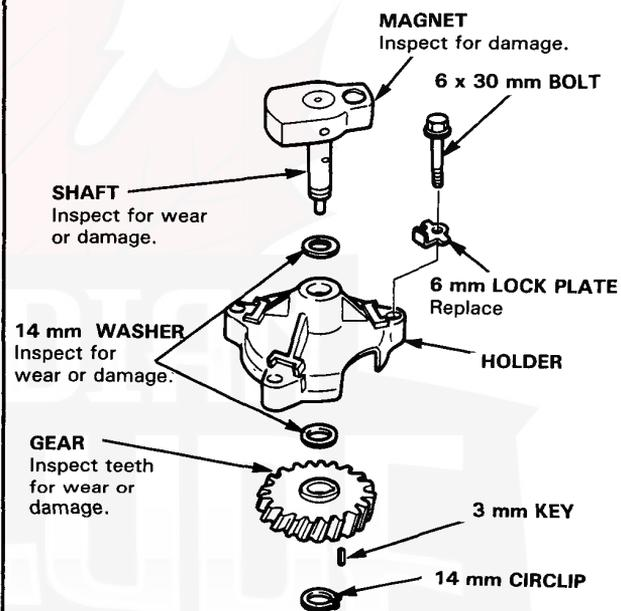

MAGNET
Inspect for damage.

6 x 30 mm BOLT

SHAFT
Inspect for wear
or damage.

6 mm LOCK PLATE
Replace

14 mm WASHER
Inspect for
wear or damage.

HOLDER

GEAR
Inspect teeth
for wear or
damage.

3 mm KEY

14 mm CIRCLIP

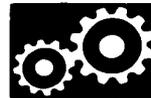

1st Accumulator/R. Side Cover

Disassembly/Inspection/Reassembly

NOTE:

- Clean all parts thoroughly in solvent or carburetor cleaner and dry with compressed air.
- Blow out all passages.
- Coat all parts with ATF before reassembly.

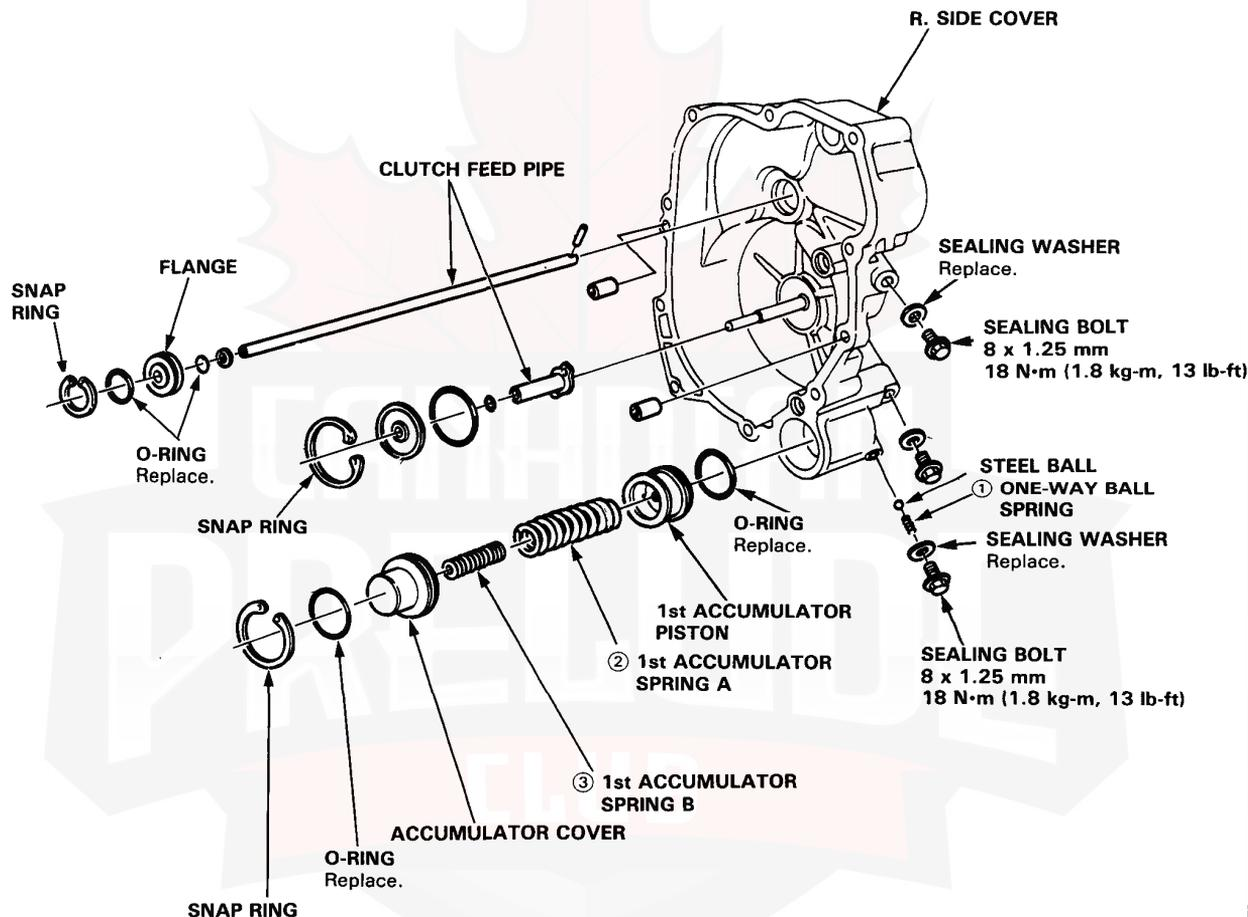

Spring Specifications

Ref. No.	Spring	Standard			
		Wire Dia. mm (in)	O.D. mm (in)	Free Length mm (in)	No. of Coils
①	One-way ball spring	0.29 (0.011)	4.0 (0.157)	14.0 (0.551)	13
②	1st accumulator spring A	2.8 (0.110)	21.5 (0.846)	56.2 (2.212)	8.9
③	1st accumulator spring B	2.8 (0.110)	9.8 (0.386)	42.0 (1.654)	9.2

Mainshaft

Disassembly/Inspection/Reassembly

NOTE:

- Lubricate all parts with ATF during reassembly.
- Install thrust needle bearings with unrolled edge of bearing retainer facing washer.
- Before installing the O-rings, wrap the shaft splines with vinyl tape to prevent damage to the O-rings.

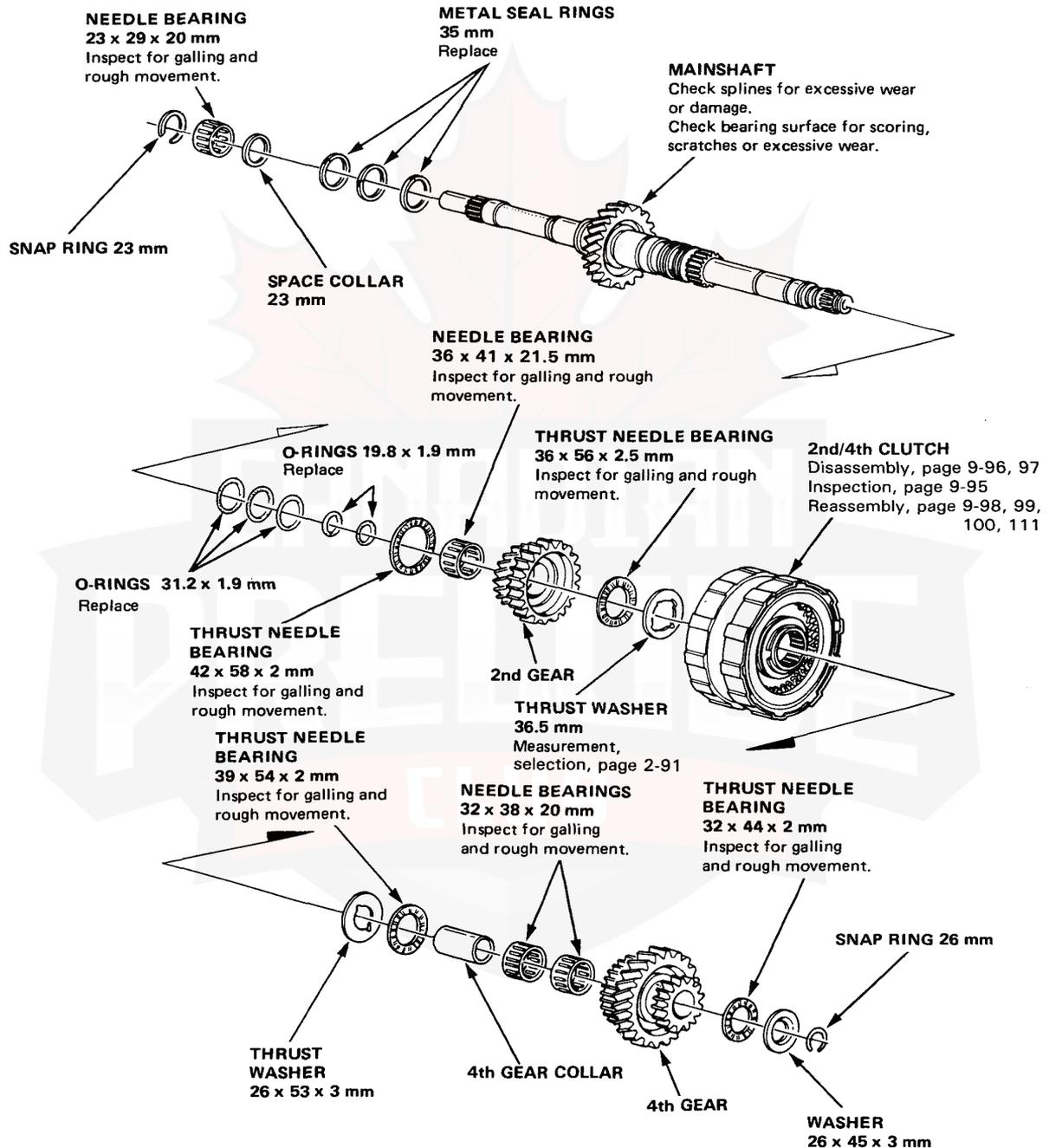

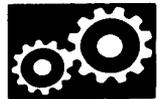

Thrust Washer Selecting

1. Install the thrust needle bearing, needle bearing, 2nd gear, thrust needle bearing, thrust washer and 2nd/4th clutch assembly to the mainshaft.

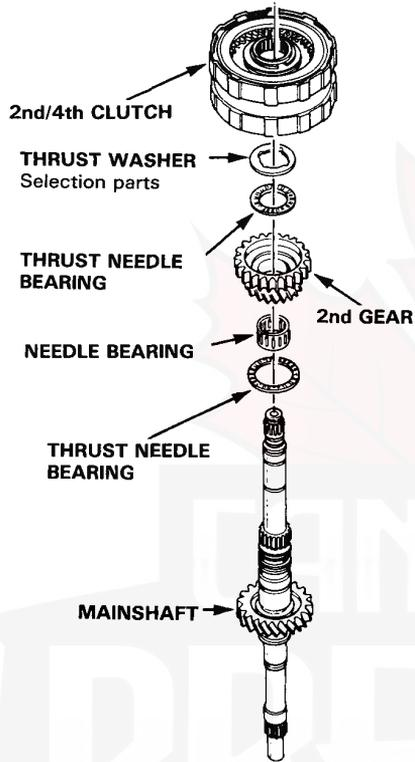

2. Attach the dial-indicator to the mainshaft 2nd gear.

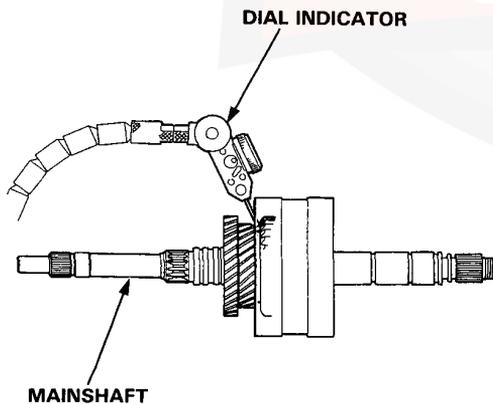

3. Measure the 2nd gear axial clearance while pushing the clutch assembly towards 3rd gear.

NOTE: Measure the clearance at three places 120° apart, and take the average as the actual clearance.

Standard: 0.07–0.15 mm
(0.003–0.006 in)

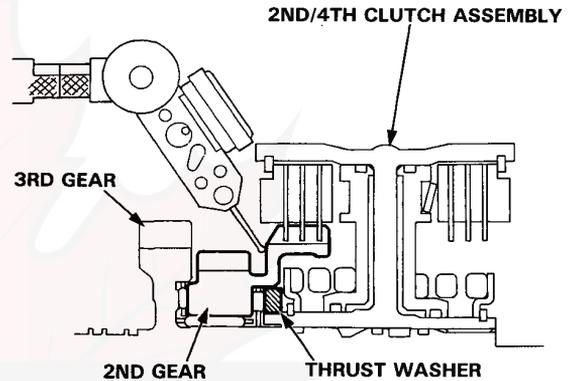

4. If the clearance exceeds the service limit, measure the thickness of the thrust washer and select one which gives the proper clearance.

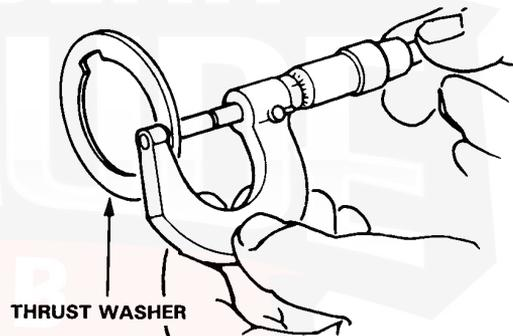

Replacement thrust washers:

P/N	THICKNESS
90441-PG4-010	3.97–4.00 mm (0.156–0.157 in)
90442-PG4-010	4.02–4.05 mm (0.158–0.159 in)
90443-PG4-010	4.07–4.10 mm (0.160–0.161 in)
90444-PG4-010	4.12–4.15 mm (0.162–0.163 in)
90445-PG4-010	4.17–4.20 mm (0.164–0.165 in)
90446-PG4-010	4.22–4.25 mm (0.166–0.167 in)
90447-PG4-010	4.27–4.30 mm (0.168–0.169 in)
90448-PG4-010	4.32–4.35 mm (0.170–0.171 in)
90449-PG4-010	4.37–4.40 mm (0.172–0.173 in)

Countershaft

Disassembly/Inspection/Reassembly

NOTE:

- Lubricate all parts with ATF during reassembly.
- Install thrust needle bearings with unrolled edge of bearing retainer facing washer.
- Before installing the O-rings, wrap the shaft splines with vinyl tape to prevent damage to the O-rings.

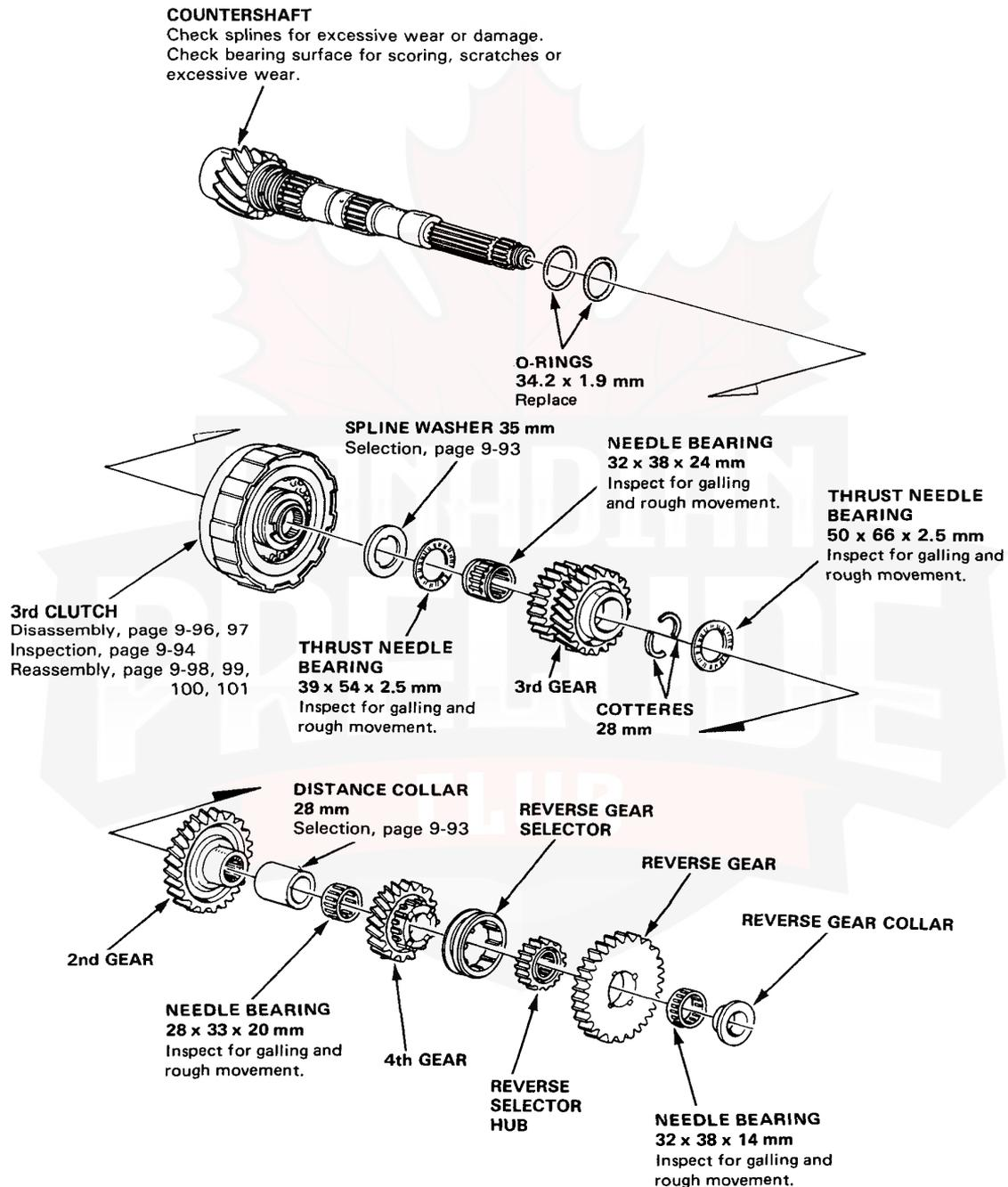

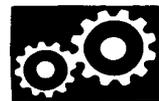

Distance Collar/Spline Washer Selecting

1. Remove the countershaft bearing from the transmission housing.
2. Assemble all parts including the counter-shaft bearing on the countershaft.
3. Torque the countershaft locknut to 30 N·m (3.0 kg-m, 22 lb-ft).
4. Measure the clearance between the shoulder on the selector hub and the shoulder on 4th gear.

Countershaft 4th Gear Clearance:

Standard: 0.07–0.15 mm (0.003–0.006 in.)

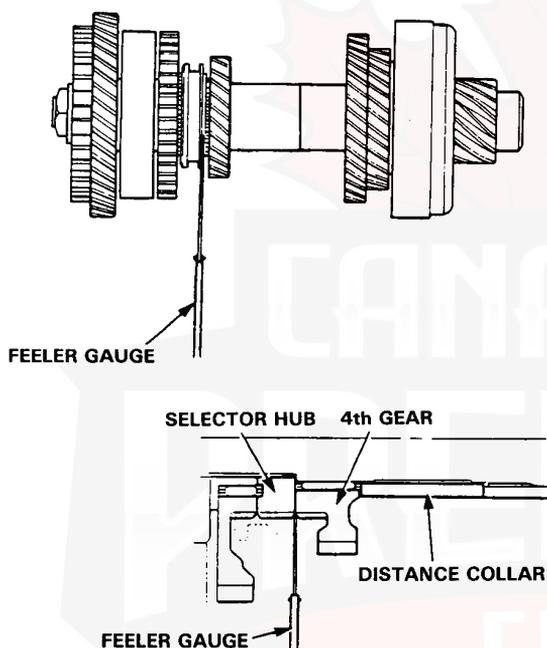

5. If the clearance exceeds the service limit, measure the thickness of the distance collar and select one which will give the correct clearance.

Replacement distance collar:

P/N	THICKNESS
90503-PC9-000	38.97–39.00 mm (1.534–1.535 in)
90508-PC9-000	39.02–39.05 mm (1.536–1.537 in)
90504-PC9-000	39.07–39.10 mm (1.538–1.539 in)
90509-PC9-000	39.12–39.15 mm (1.540–1.541 in)
90505-PC9-000	39.17–39.20 mm (1.542–1.543 in)
90510-PC9-000	39.22–39.25 mm (1.544–1.545 in)
90507-PC9-000	39.27–39.30 mm (1.546–1.547 in)
90511-PC9-000	39.87–39.90 mm (1.570–1.571 in)
90512-PC9-000	39.92–39.95 mm (1.572–1.573 in)

6. Slide the 3rd gear out fully. Measure and record the clearance between the 2nd and 3rd gears with a feeler gauge.

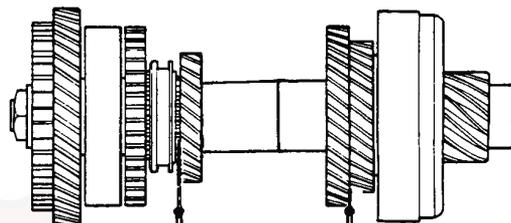

Leave the feeler gauge inserted between the 4th gear and the selector hub.

- Slide the 3rd gear in fully and again measure the clearance between 2nd and 3rd gears.
- Calculate the difference between the two readings to determine the actual clearance.

Service Limit: 0.07–0.15 mm (0.003–0.006 in)

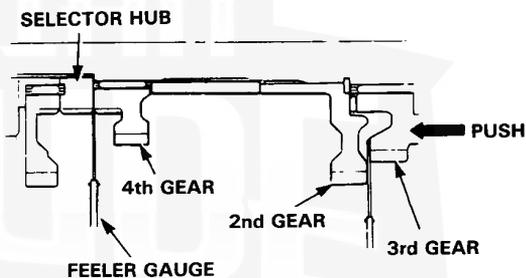

7. If the clearance exceeds the service limit, measure the thickness of the spline washer and select one which will give the correct clearance.

Replacement spline washer:

P/N	THICKNESS
90411-PF4-000	2.97–3.00 mm (0.117–0.118 in)
90412-PF4-000	3.02–3.05 mm (0.119–0.120 in)
90413-PF4-000	3.07–3.10 mm (0.121–0.122 in)
90414-PF4-000	3.12–3.15 mm (0.123–0.124 in)
90415-PF4-000	3.17–3.20 mm (0.125–0.126 in)
90416-PF4-000	3.22–3.25 mm (0.127–0.128 in)
90417-PF4-000	3.27–3.30 mm (0.129–0.130 in)
90418-PF4-000	3.32–3.35 mm (0.131–0.132 in)
90419-PF4-000	3.37–3.40 mm (0.133–0.134 in)

Clutch

Illustrated Index

1st Clutch

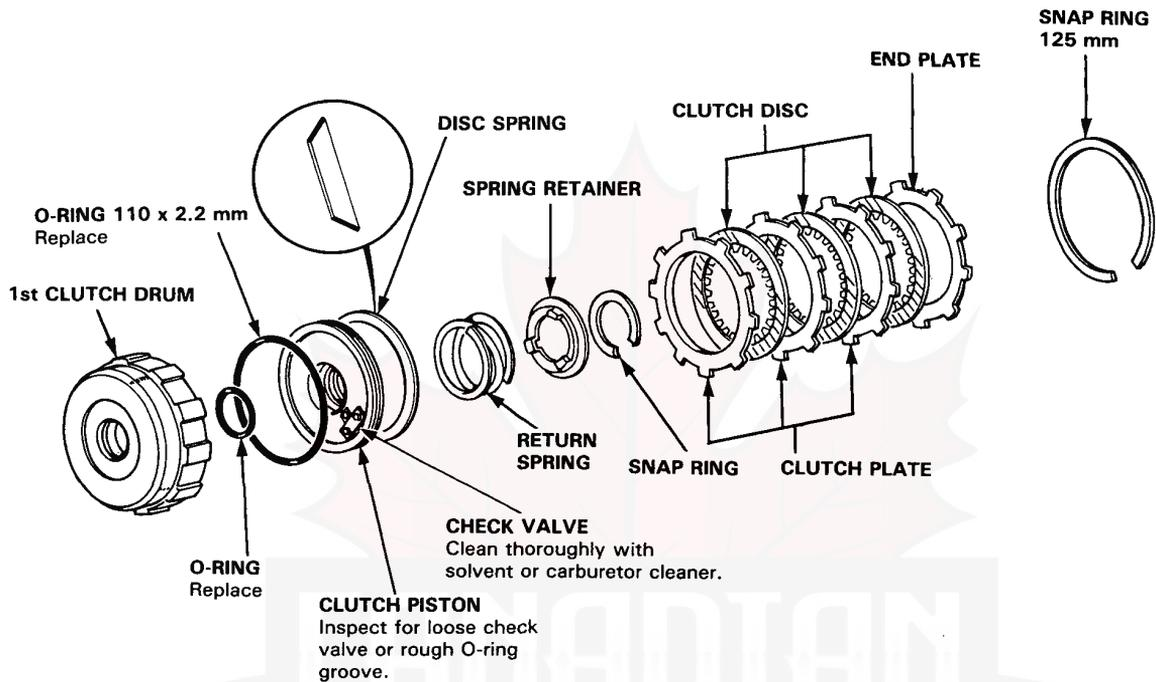

3rd Clutch

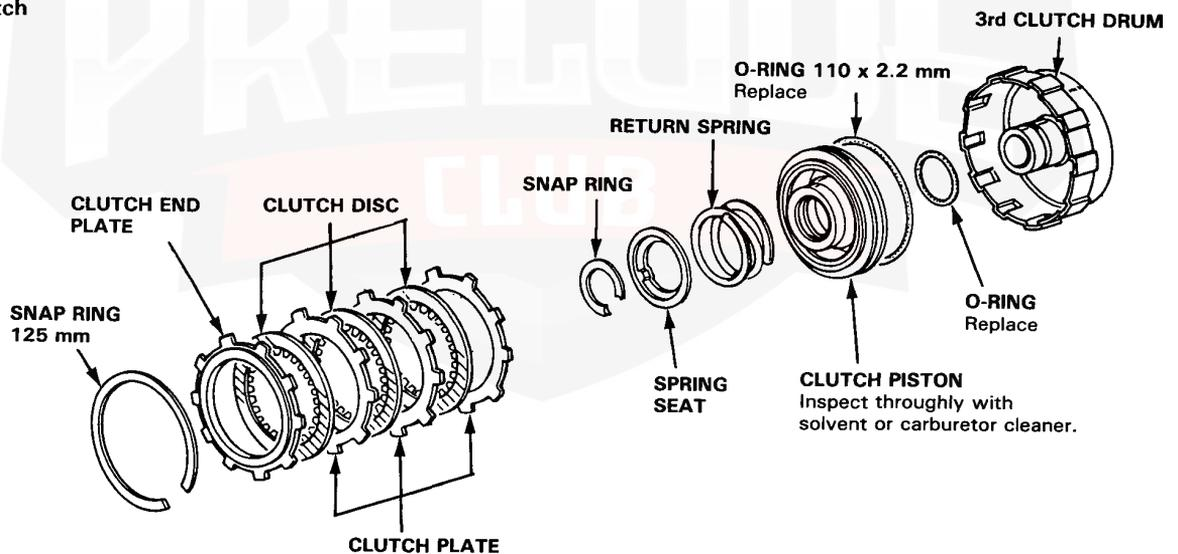

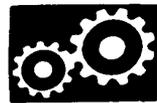

2nd/4th Clutch

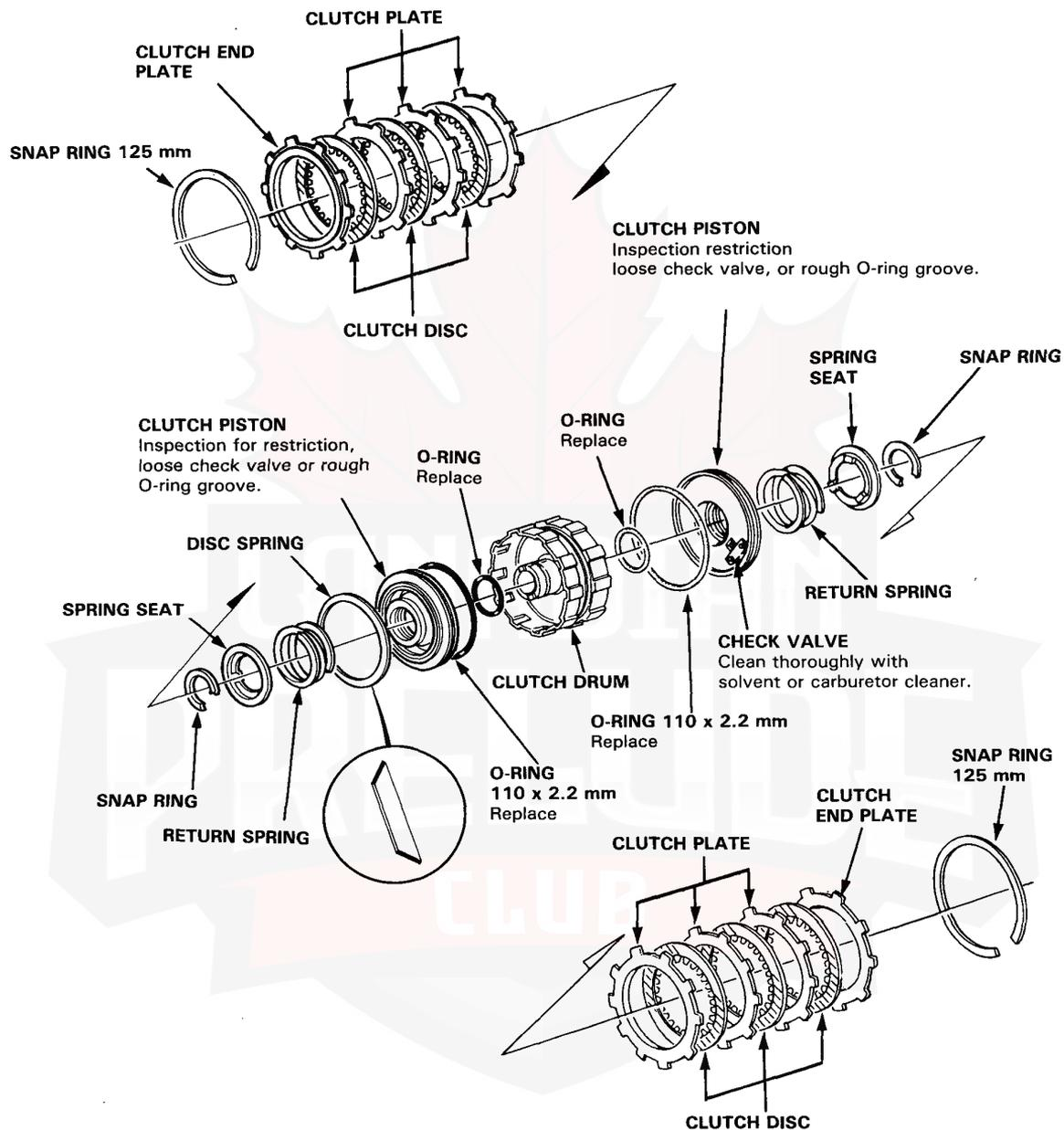

Clutch

Disassembly

1. Remove the snap ring, then remove the clutch end plate, clutch discs and plates.

NOTE: For all clutches.

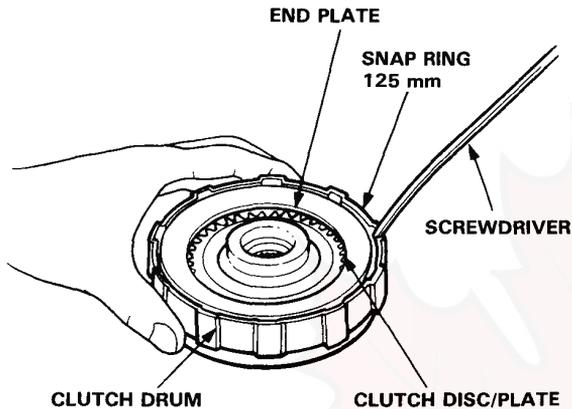

2. Remove the disc spring.

NOTE: For 1st and 2nd clutches.

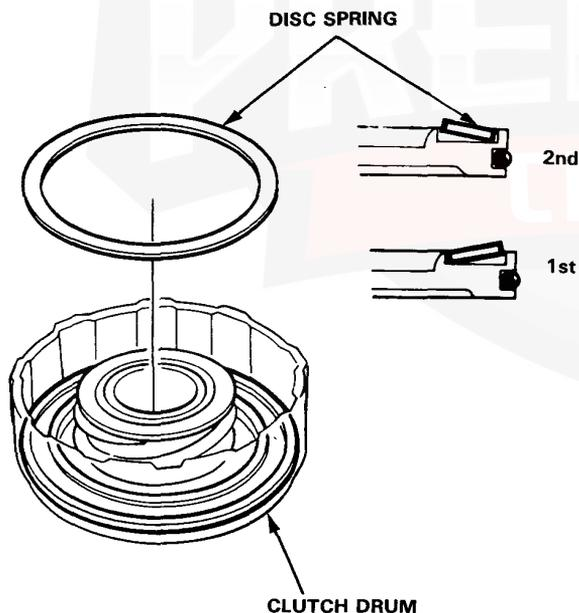

3. Install the special tools as shown.

NOTE: For 1st and 3rd clutches.

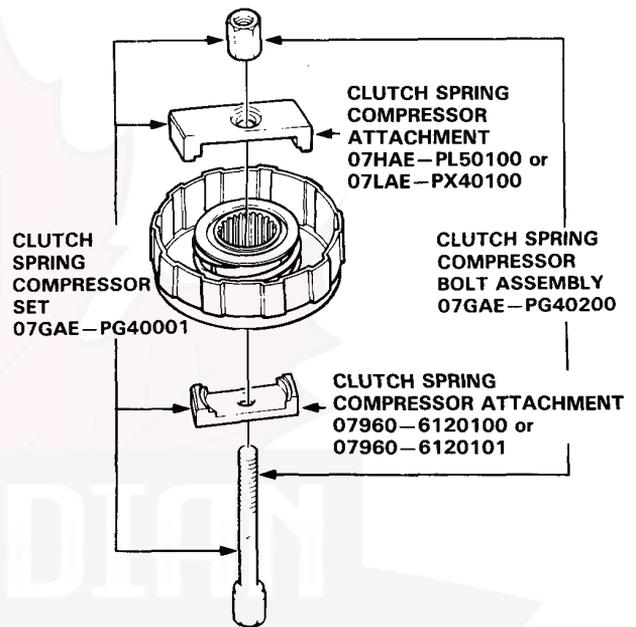

NOTE: For 2nd/4th clutches.

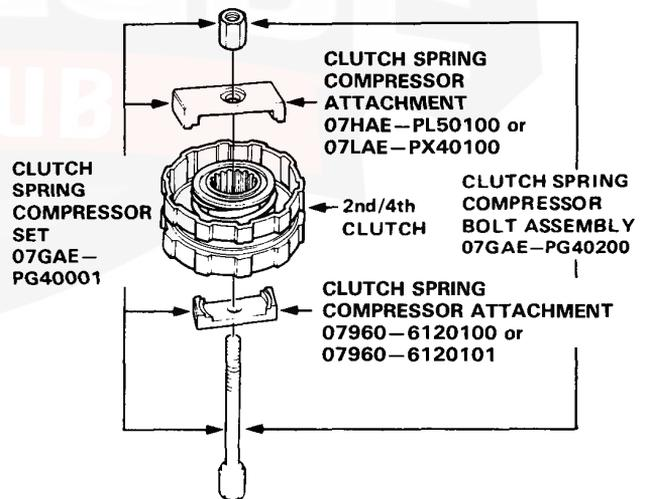



CAUTION: If either end of the compressor attachment is set over an area of the retainer which is unsupported by the spring, the retainer may be damaged.

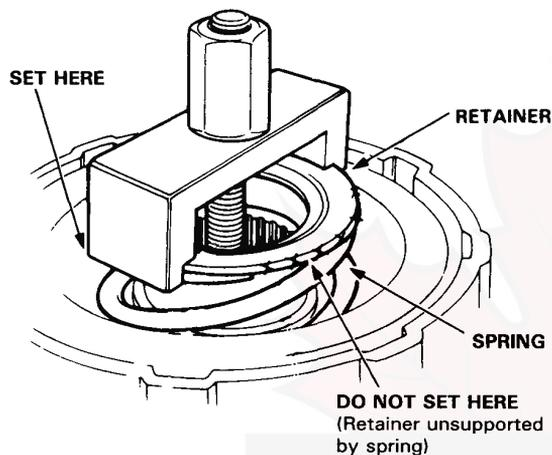

NOTE: Step 4 thru 6 are for all clutches.

4. Compress the clutch return spring.

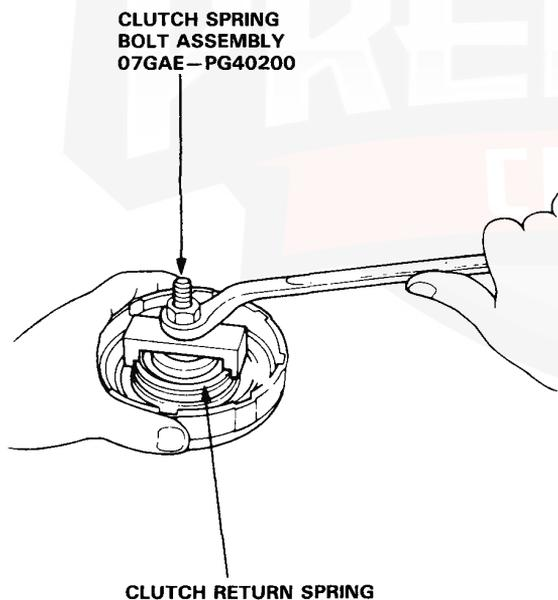

5. Remove the snap ring. Then remove the special tools, spring retainer and return spring.

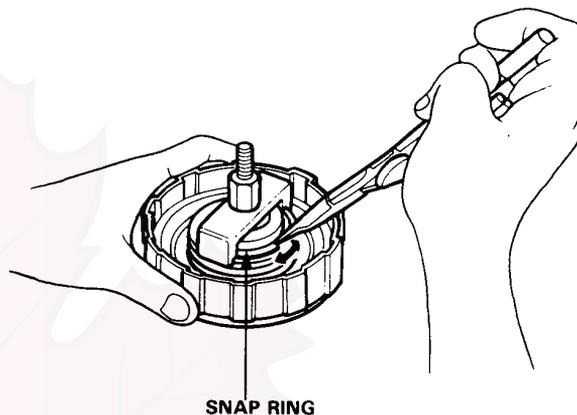

6. Wrap a shop rag around the clutch drum and apply air pressure to the oil passage to remove the piston. Place a finger tip on the other end while applying air pressure.

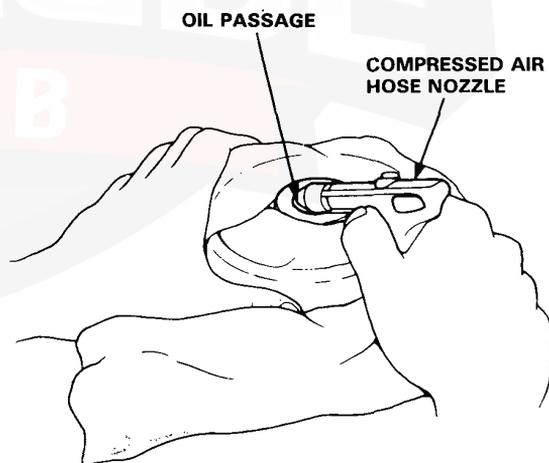

Clutch

Reassembly

NOTE:

- Clean all parts thoroughly in solvent or carburetor cleaner, and dry with compressed air.
- Blow out all passages.
- Lubricate all parts with ATF before reassembly.

1. Install a new O-ring on the clutch piston.

NOTE: For all clutches.

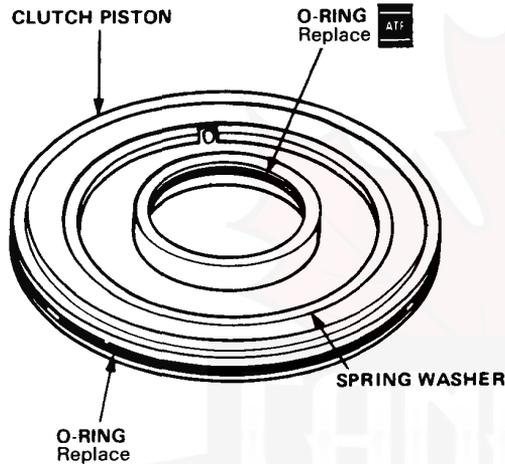

2. Be sure that the disc spring is securely staked.

NOTE: For 3rd and 4th clutches.

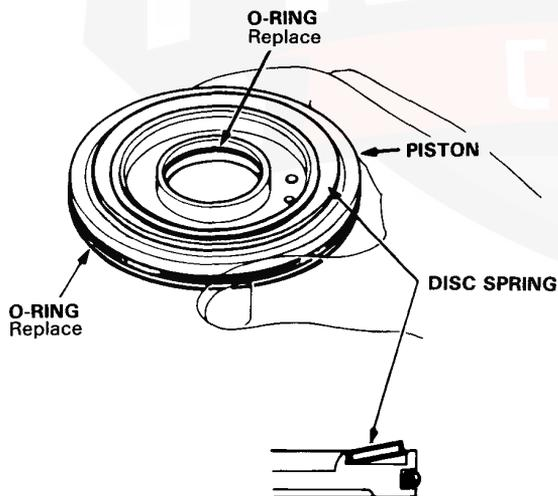

3. Install the piston in the clutch drum. Apply pressure and rotate to ensure proper seating.

NOTE:

- For all clutches.
- Lubricate the piston O-ring with ATF before installing.

CAUTION: Do not pinch O-ring by forcing piston installation.

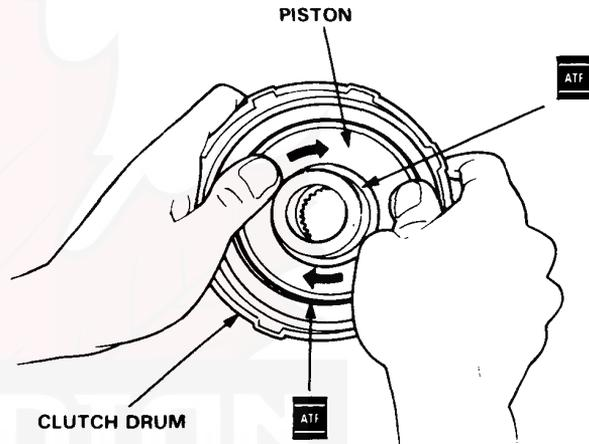

4. Install the return spring and spring retainer and position the snap ring on the retainer.

NOTE: For all clutches.

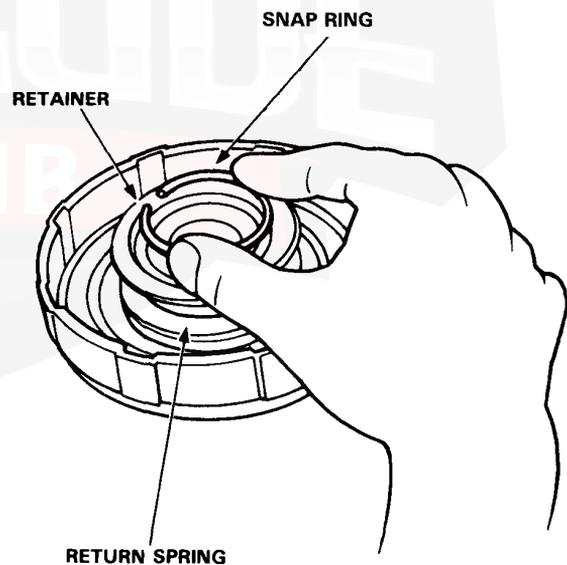

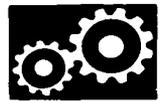

5. Install the special tools as shown.

NOTE: For 1st and 3rd clutches.

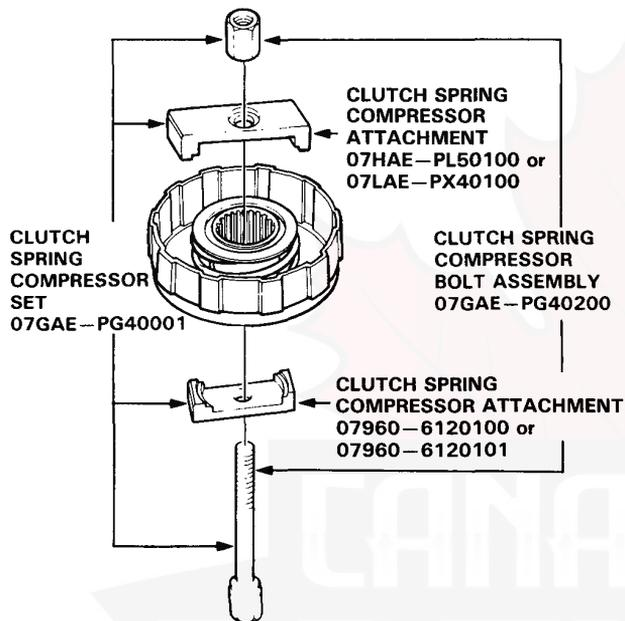

NOTE: For 2nd/4th clutch.

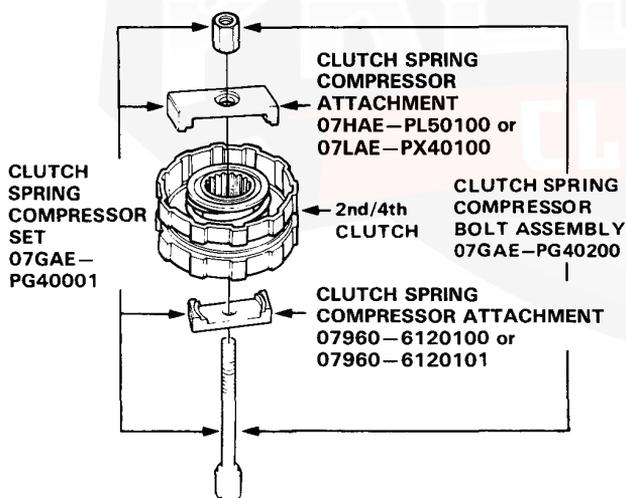

CAUTION: If either end of the compressor attachment is set over an area of the retainer which is unsupported by the spring, the retainer may be damaged.

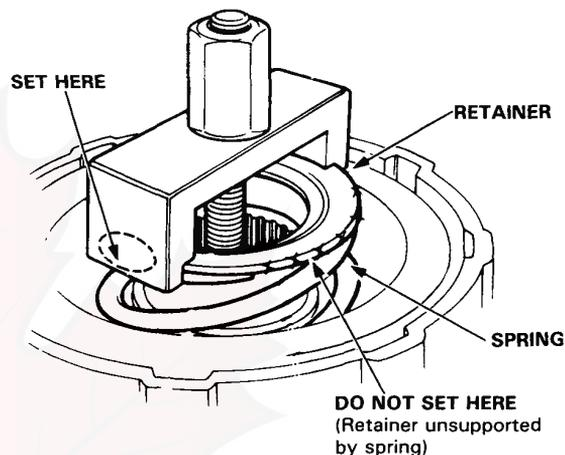

6. Compress the clutch return spring.

NOTE: For all clutches.

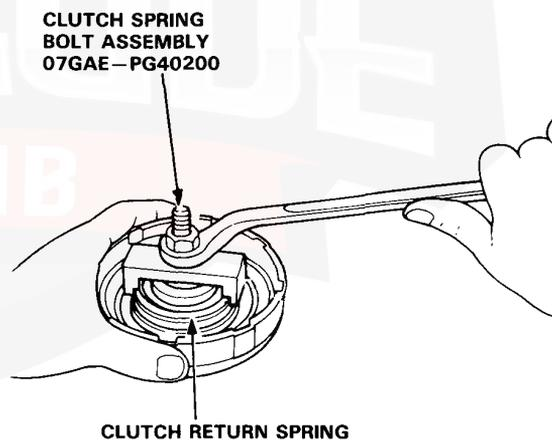

(cont'd)

Clutch

Reassembly (cont'd)

7. Install the snap ring.

NOTE: For all clutches.

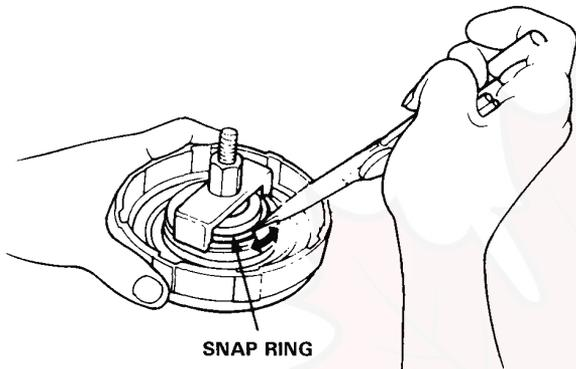

8. Remove the special tools.

NOTE: For all clutches.

9. Install the disc springs.

NOTE:

- For 1st and 2nd clutches.
- Install the disc spring in the right direction.

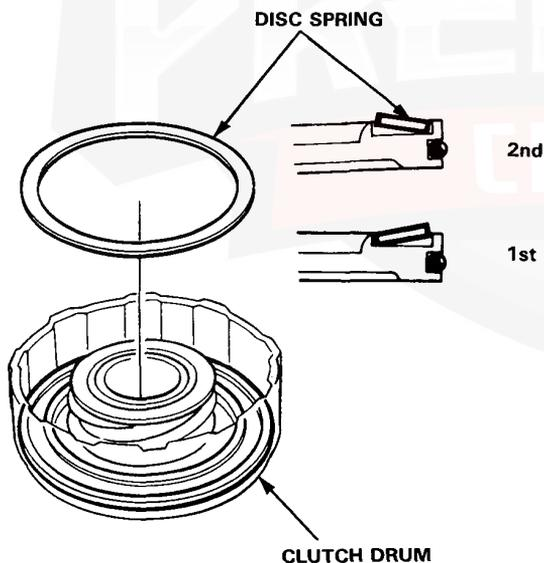

NOTE: Steps 10 thru 14 are for all clutches.

10. Soak the clutch discs thoroughly in automatic transmission fluid for a minimum of 30 minutes.

11. Starting with a clutch plate, alternately install the clutch plates and discs. Install the clutch end plate with flat side toward the disc.

NOTE: Before installing the plates and discs, make sure the inside of the clutch drum is free of dirt or other foreign matter.

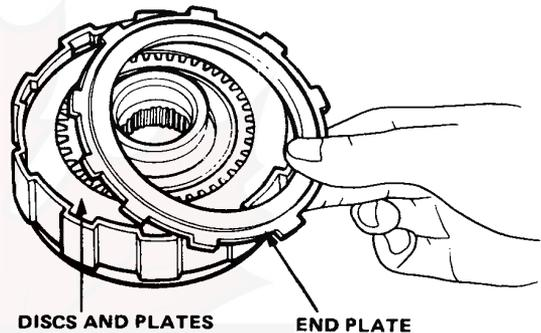

12. Install the snap ring.

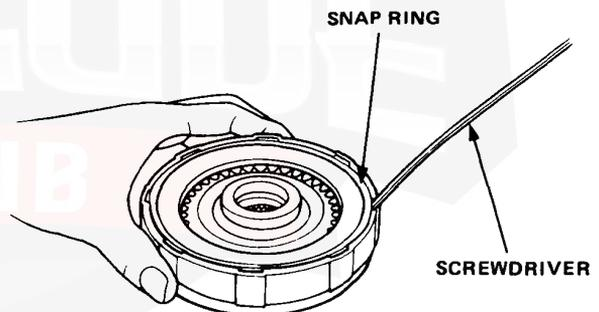

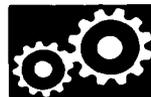

13. Measure the clearance between the clutch end plate and top disc with a dial indicator.

Zero the dial indicator with the clutch end plate lowered and lift it up to the snap ring. The distance that the clutch end plate moves is the clearance between the clutch end plate and top disc.

NOTE: Measure at three locations.

End Plate-to-Top Disc Clearance:

	Service Limit	
1ST	0.65–0.85 mm	(0.026–0.033 in.)
2ND	0.40–0.60 mm	(0.016–0.024 in.)
3RD	0.40–0.60 mm	(0.016–0.024 in.)
4TH	0.40–0.60 mm	(0.016–0.024 in.)

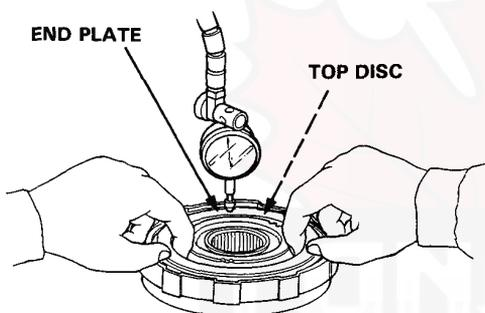

14. If the clearance is not within the service limits, select a new clutch end plate from the following table.

NOTE: If the thickest clutch end plate is installed but the clearance is still over the standard, replace the clutch discs and clutch plates.

P/N	PLATE NO.	THICKNESS
22551–PF4–000	1	2.1 mm (0.082 in.)
22552–PF4–000	2	2.2 mm (0.086 in.)
22553–PF4–000	3	2.3 mm (0.090 in.)
22554–PF4–000	4	2.4 mm (0.094 in.)
22555–PF4–000	5	2.5 mm (0.098 in.)
22556–PF4–000	6	2.6 mm (0.102 in.)
22557–PF4–000	7	2.7 mm (0.106 in.)
22558–PF4–000	8	2.8 mm (0.110 in.)
22559–PF4–000	9	2.9 mm (0.114 in.)
22560–PF4–000	10	3.0 mm (0.118 in.)
22561–PF4–000	11	3.1 mm (0.122 in.)
22562–PF4–000	12	3.2 mm (0.126 in.)
22563–PF4–000	13	3.3 mm (0.130 in.)
22564–PF4–000	14	3.4 mm (0.134 in.)

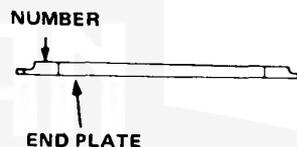

Transmission

Reassembly

NOTE: Coat all parts with ATF.

1. Reassemble the transmission in the following numbered sequence.

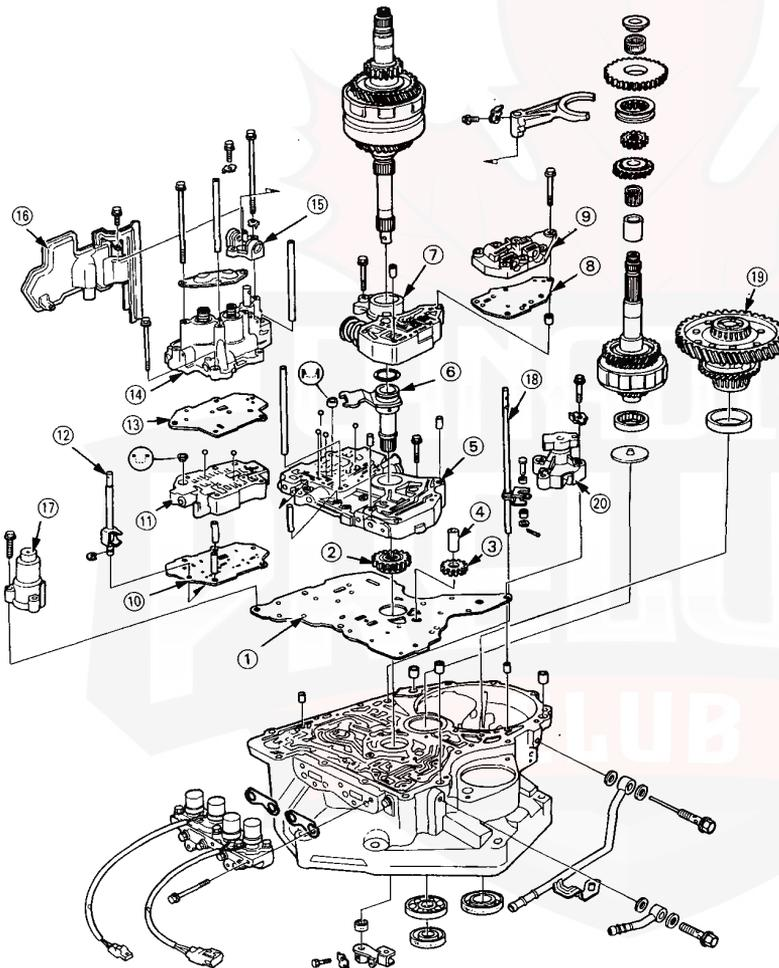

② ③ ④ ⑤

NOTE: Install the oil pump driven gear with its chamfered side facing down.

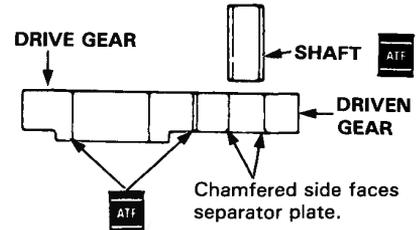

NOTE: Make sure the pump drive gear rotates smoothly in the normal operating direction and the pump shaft moves smoothly in the axial and normal operating directions.

CAUTION: If the pump gear and pump shaft do not move freely, loosen the valve body bolts, realign the shaft, and then retighten to the specified torque. Failure to align the pump shaft correctly will result in seized pump gear or pump shaft.

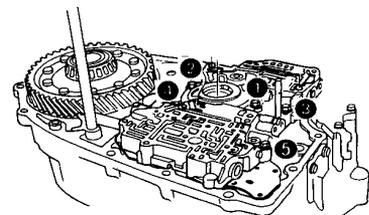
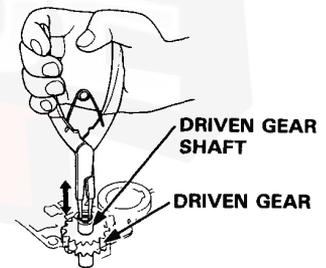
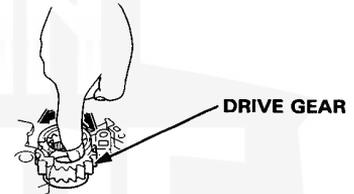

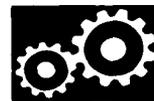

2. Set the countershaft and mainshaft in place as an assembly.

NOTE: Do not tap on the shafts with a hammer to drive in.

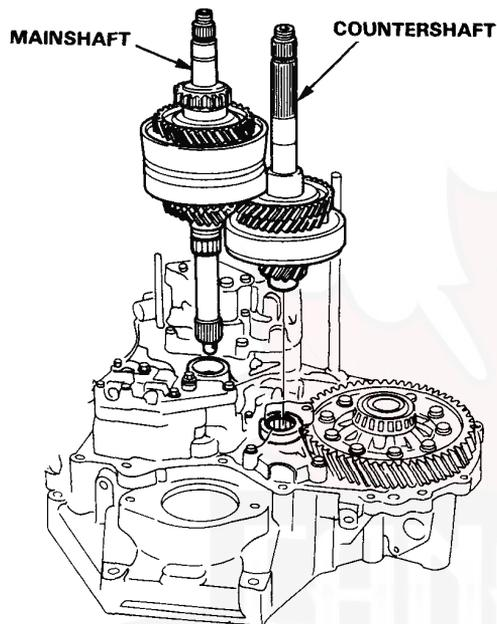

3. Install the distance collar, needle bearing, countershaft 4th gear, reverse shaft fork, reverse gear selector and reverse selector hub.

NOTE:

- Install the reverse gear selector with its flat face up.
- Install the reverse gear selector hub with the groove facing up.

4. Install the reverse shift fork over the servo valve stem. Align the hole in the stem with hole in fork as shown, and install the bolt and new lock plate. Bend the lock tab against the bolt head.

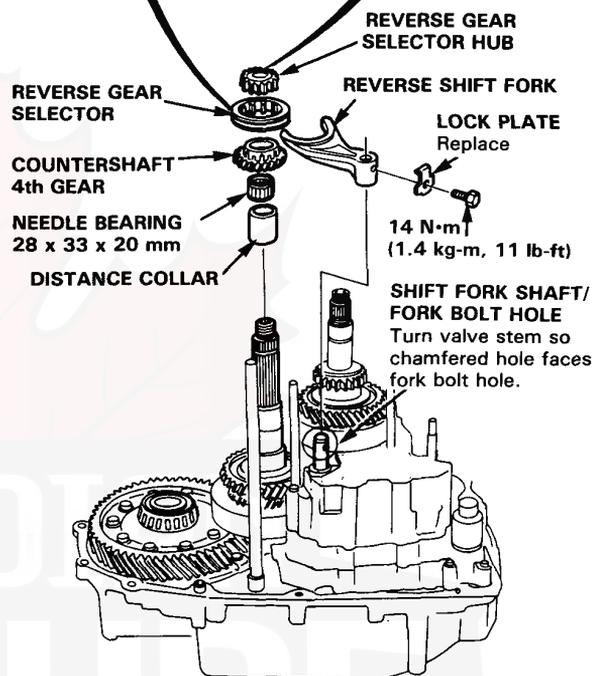
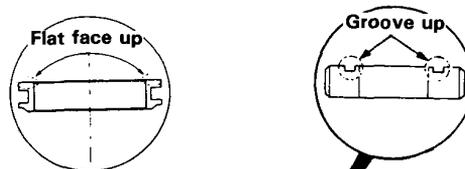

5. Install the countershaft reverse gear, needle bearing, and reverse gear collar.

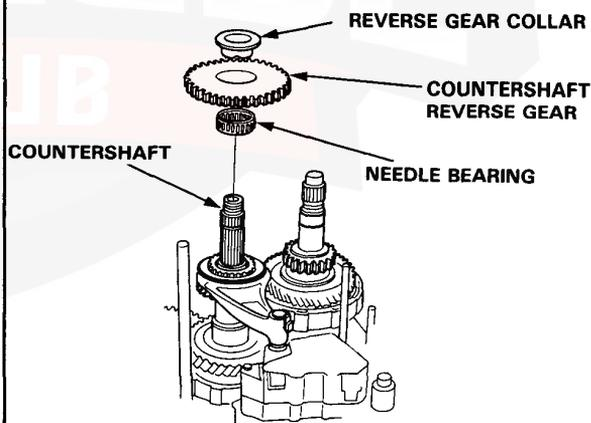

6. Install the new gasket and three dowel pins in the torque converter housing.

(cont'd)

Transmission

Reassembly (cont'd)

- Place the transmission housing on the torque converter housing.

NOTE: Be sure that the spring pin of the control shaft lines up with the hole in the housing and that the reverse idler gear meshes with the mainshaft and countershaft, or the housing will not go on.

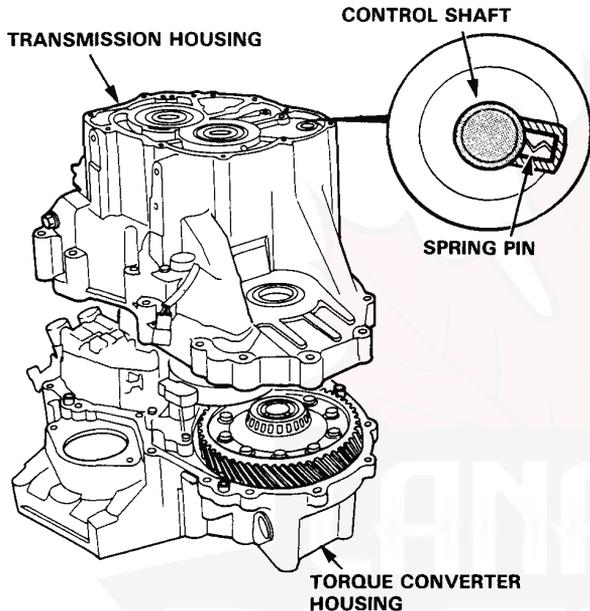

- Torque bolts to 55 N·m (5.5 kg·m, 40 lb-ft) in order of (1) thru (16) in two or more steps. Install the dipstick.

NOTE: When tightening the transmission housing bolts, take care that you do not distort or damage the throttle control bracket; distortion or damage to the bracket will change transmission shift points.

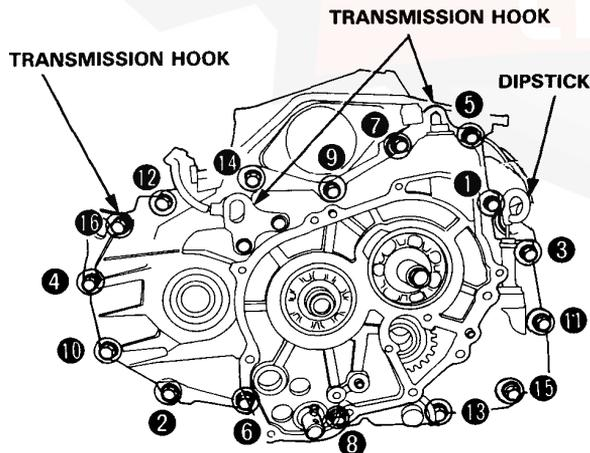

- Install the throttle control lever and spring on the throttle control shaft.

- Install the bolt and a new lock plate. Bend the lock tab against the bolt head.

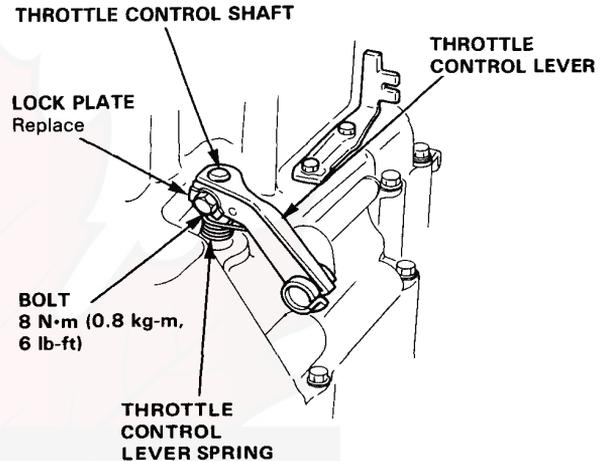

- Install the parking brake roller, roller pin and washer on the parking shift arm and secure with a new cotter pin.

- Install the parking brake spring, parking shift arm and parking brake stopper on the shift shaft with the bolt. Bend the lock tab against the bolt head.

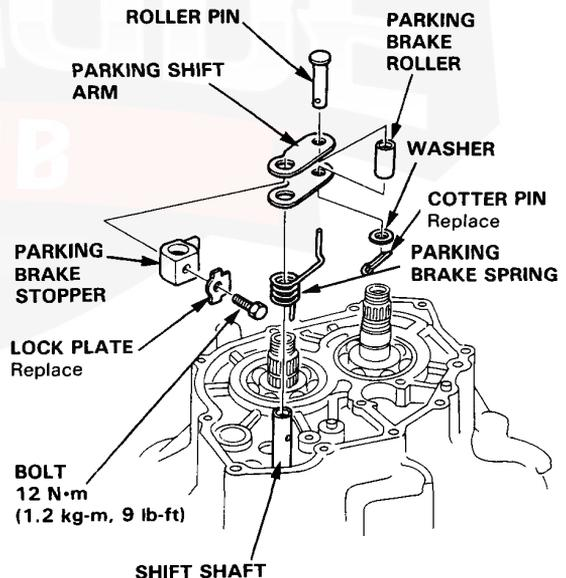

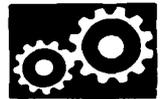

13. Install the countershaft 1st gear collar and needle bearing on the countershaft. Install the 1st gear collar and new O-rings on the mainshaft.

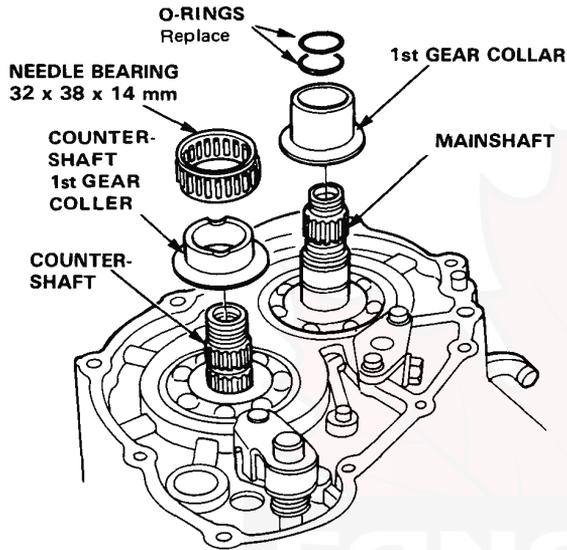

14. Install the parking gear and countershaft 1st gear on the countershaft with a 34 mm socket wrench and mallet. Loosely install a new lock nut on the countershaft.

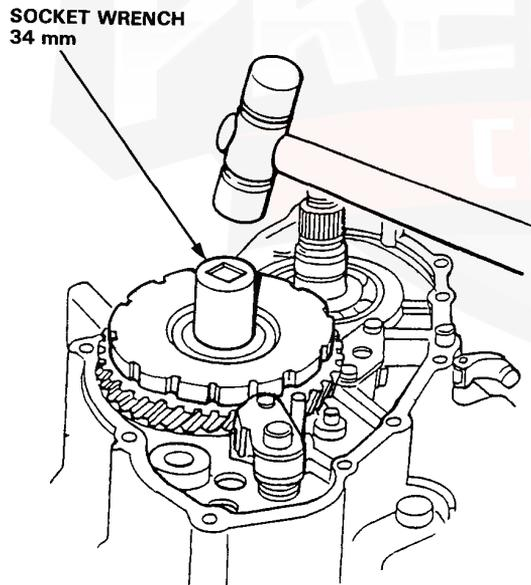

15. Install the stop pin, parking pawl shaft, pawl release spring and parking pawl.

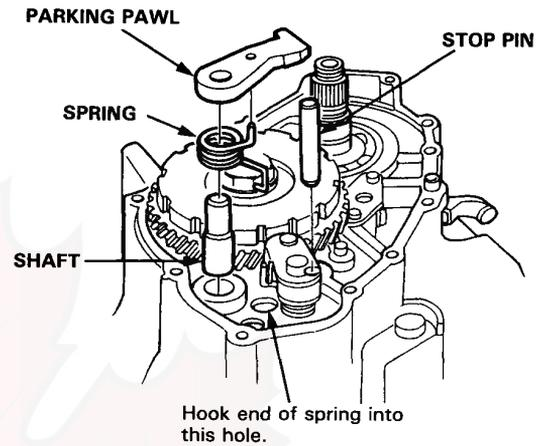

NOTE:

- One end of the parking pawl release spring fits into the hole in the parking pawl, the other end into the hole in the transmission housing as shown.
- The release spring should put clockwise tension on the pawl, forcing it away from the parking gear.

16. Shift to PARK and install the mainshaft holder.

17. Install and torque the new countershaft locknut. Tighten to specified torque, then loosen and retighten to same torque.

COUNTERSHAFT LOCK NUT

140 → 0 → 140 N·m
(14.0 → 0 → 14.0 kg-m, 102 → 0 → 102 lb-ft)

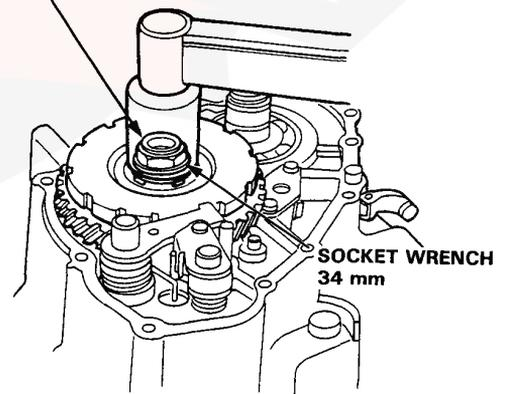

(cont'd)

Transmission

Reassembly (cont'd)

18. Stake the lock nut flange at two places into the gear grooves using a 3.5 mm punch.

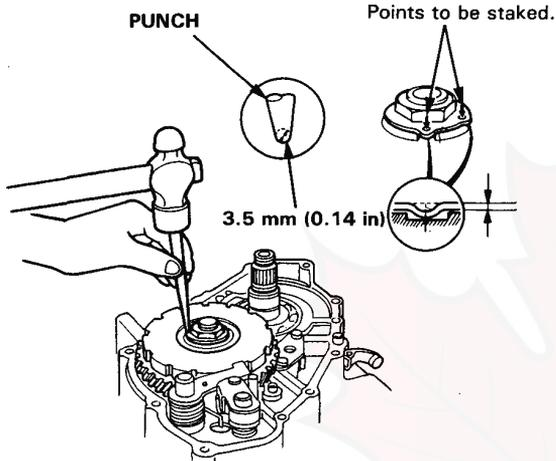

19. Install the thrust washer, 1st gear and 31 x 36 x 18.5 mm needle bearing on the mainshaft.

20. Install the thrust needle bearing, and the thrust washer on the mainshaft.

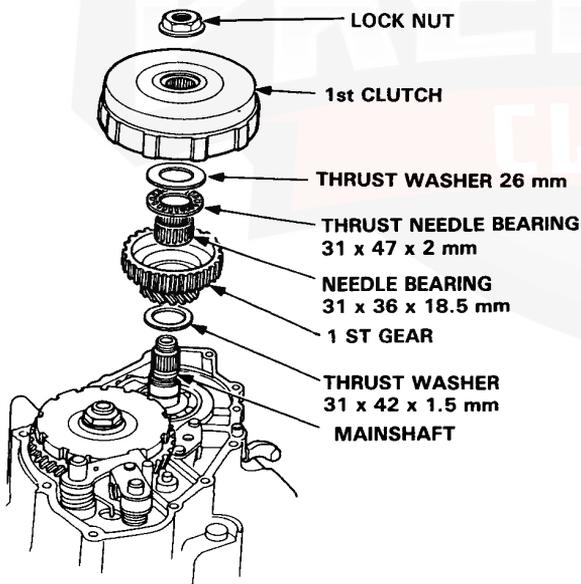

21. Install the 1st clutch assembly on the mainshaft.

22. Attach the mainshaft holder from the underside of the torque converter case.

NOTE: Refer to page 9-78 for the mainshaft holder.

23. Torque the new mainshaft lock nut. Tighten to specified torque, then loosen and retighten to same torque.

CAUTION: Lock nut has left-hand threads.

LOCK NUT 19 mm
95 → 0 → 95 N·m
(9.5 → 0 → 9.5 kg·m, 70 → 0 → 70 lb-ft)

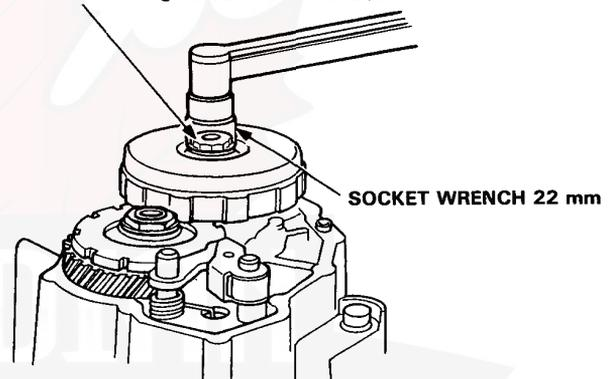

24. After tightening the nut, make sure that the 1st gear does not turn and clutch drum turns smoothly. Stake the lock nut flange into the groove in the 1st clutch.

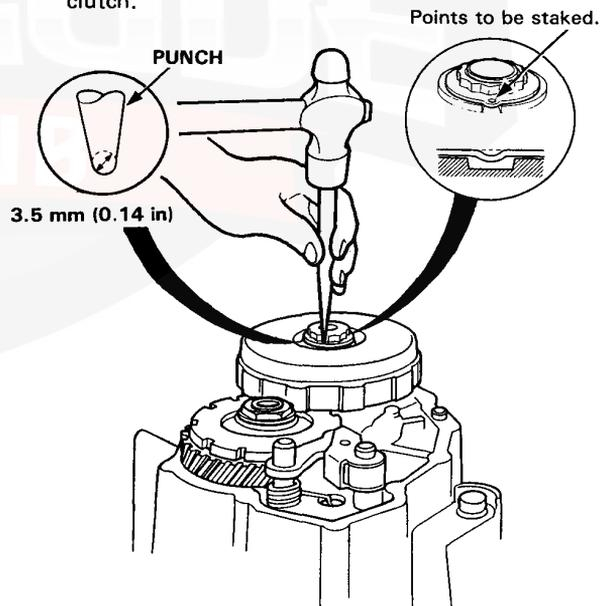

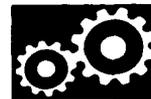

25. Install a new gasket, dowel pins, and new O-rings on the transmission housing.

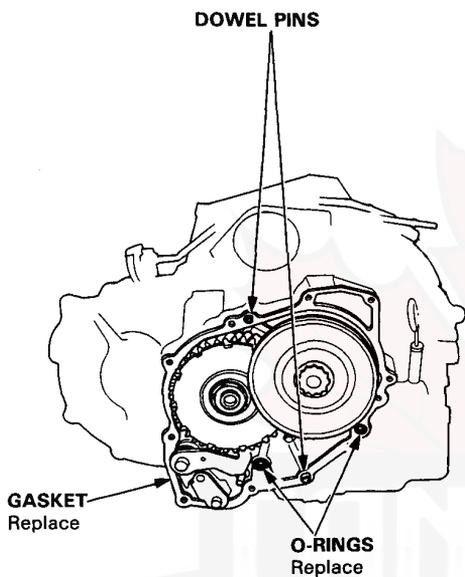

26. Install the end cover and torque all 10 bolts to 12 N·m (1.2 kg-m, 9 lb-ft).

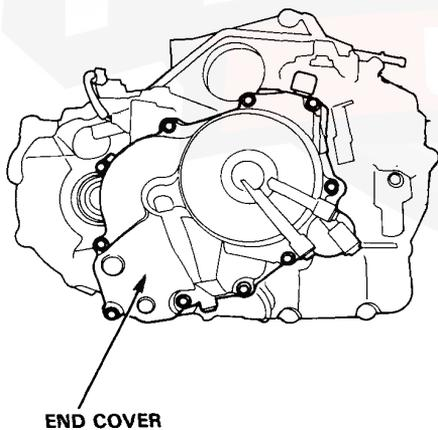

27. Install the transmission oil cooler pipes A and B on the transmission housing with new sealing washers.

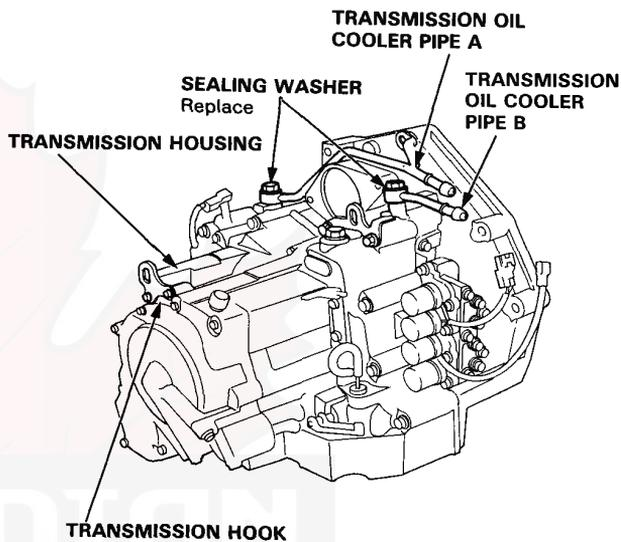

Transmission

Installation

1. Place the transmission on the transmission jack and raise to the engine level.
2. Secure the transmission to the engine with the mounting bolts.
3. Attach the torque converter to the drive plate with mounting bolts, and torque to 12 N·m (1.2 kg-m, 9 lb-ft). Rotate the crank as necessary to tighten bolts to 1/2 final torque, then final torque, in a crisscross pattern. Check for free rotation after tightening the last bolt.
4. Install the transmission to the rear engine mount bracket with mounting bolts.

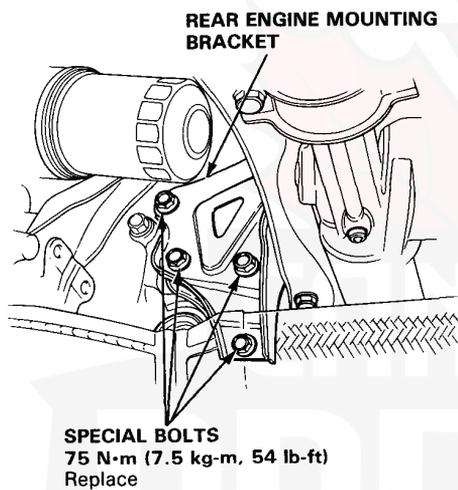

5. Install the shift control cable and fasten in with the control pin and the split pin.

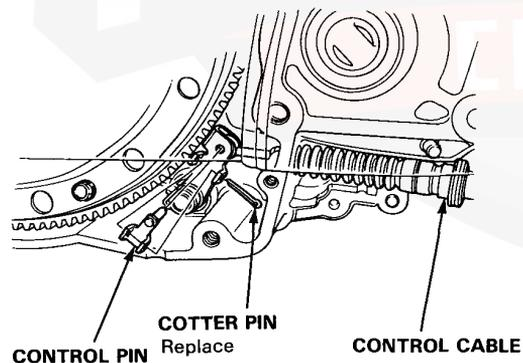

6. Install the torque converter covers.
7. Install the cable holder.

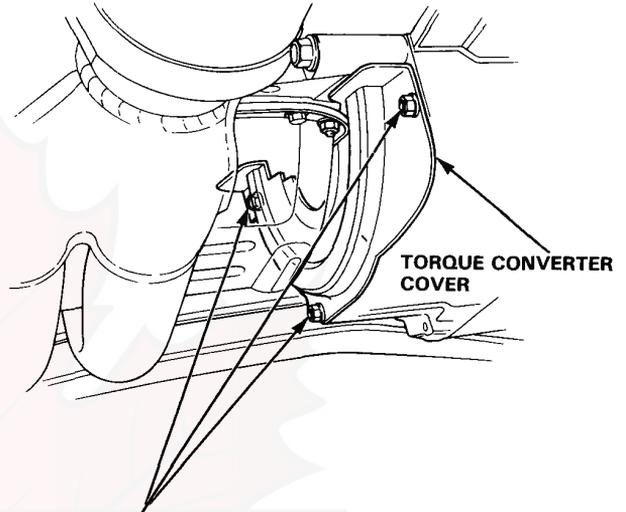

8. Install the engine stiffener.

NOTE: Tighten bolts 1 to 4 in order to torque specified below.

39 N·m (3.9 kg-m, 28 lb-ft)

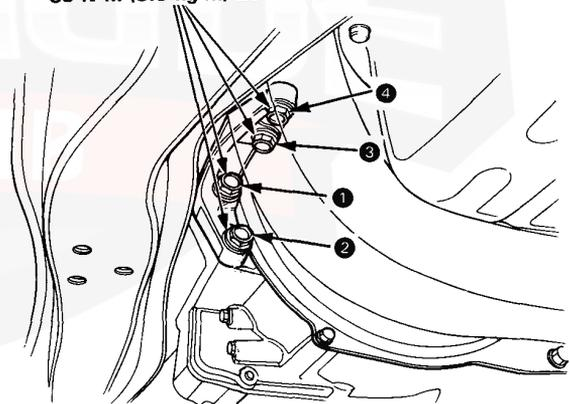

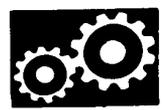

9. Install the intermediate shaft.
10. Install the right and left drive shaft.

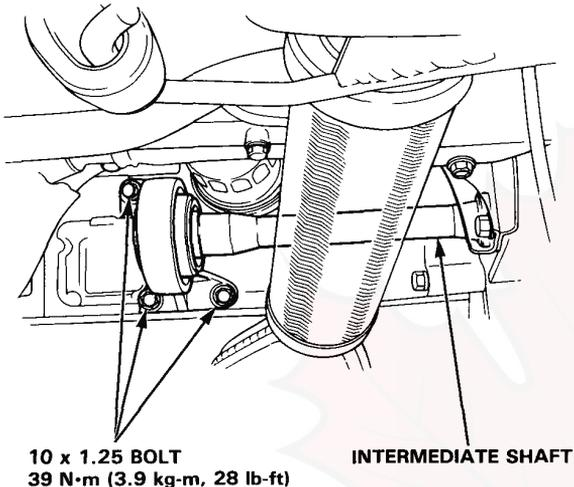

11. Install the center beam.
12. Install the right and left front damper fork.
13. Install the radius rod on the transmission side.
14. Install the transmission mounting bracket.

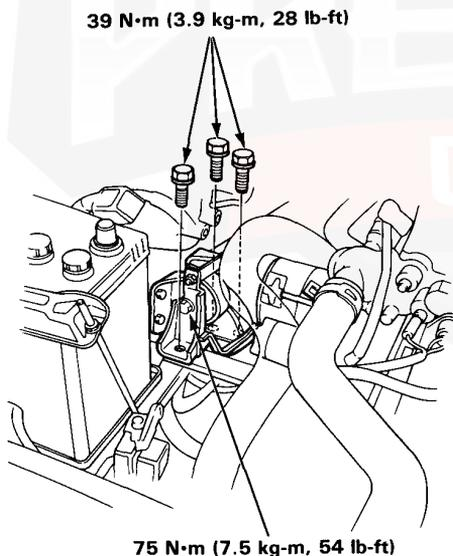

15. Connect the lock-up control solenoid valve connector, the shift control solenoid valve coupler and connector of the speed pulser.
16. Connect the oil cooler inlet and outlet hoses.
17. Connect the throttle control cable to the throttle control lever.
18. Install the speed sensor assembly.
19. Install the air cleaner case.
20. Refill the transmission with ATF.
21. Connect the starter and ground cables.
22. Connect the battery positive (+) and negative (-) cables to the battery.
23. Start the engine, set the parking brake, and shift the transmission through all gears three times. Check for proper control cable adjustment.
24. Let the engine reach operating temperature with the transmission in Neutral or Park, then turn it off and check the fluid level.
25. Road test as described on page 9-61.

Gearshift Selector

Removal/Installation

1. Remove the catalytic converter and exhaust pipe B.
2. Remove the floor heat baffle plate.
3. Remove the gearshift selector mounting nuts.
4. Remove the center console.
5. Disconnect the shift position console switch, S₄ switch, shift lock solenoid, and shift indicator light coupler.
6. Remove the lock pin from the cable adjuster, then remove the shift cable.
7. Remove the gearshift selector assembly.
8. Installation is in the reverse order of removal.

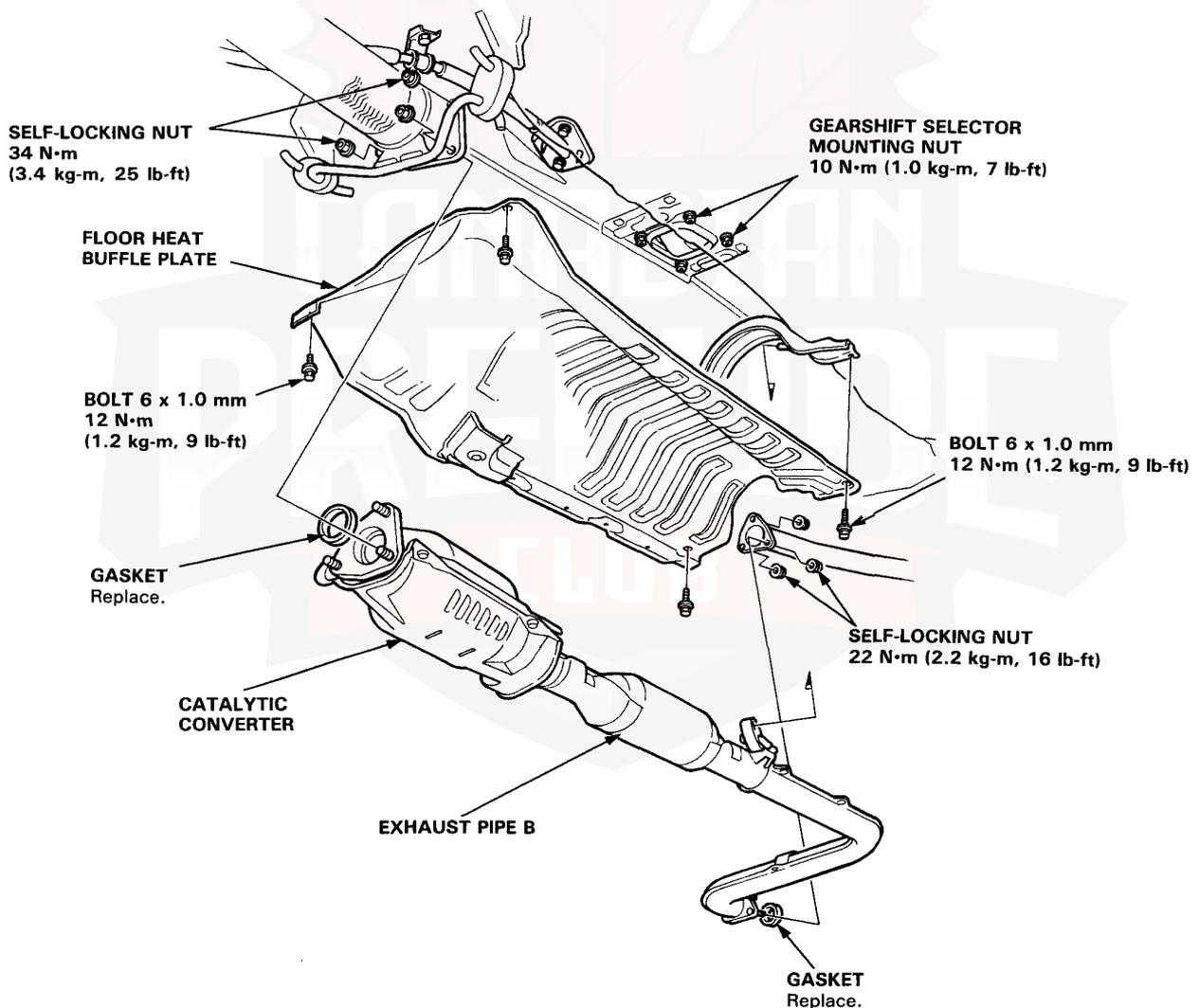

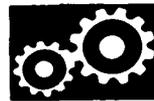

Shift Cable

Adjustment

1. Start the engine. Shift to reverse to see if the reverse gear engages. If not, refer to Troubleshooting.
2. With the engine off, remove the console.
3. Shift to **N** position, then remove the lock pin from the cable adjuster.

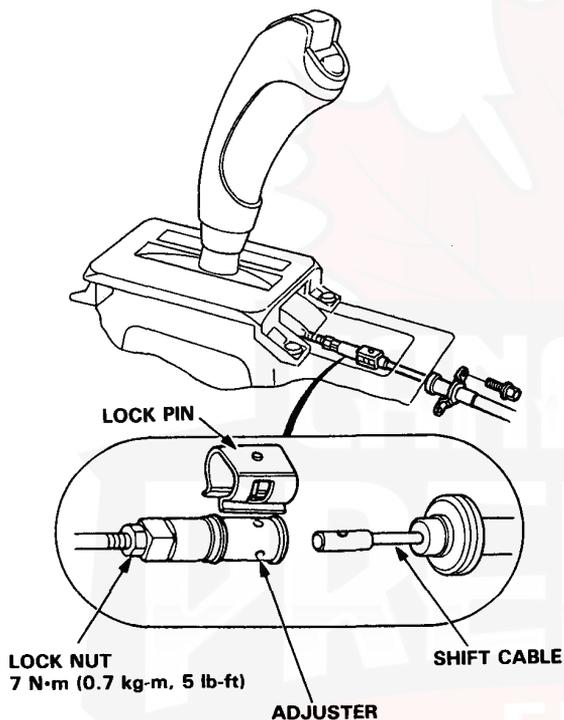

4. Check that the hole in the adjuster is perfectly aligned with the hole in the shift cable.

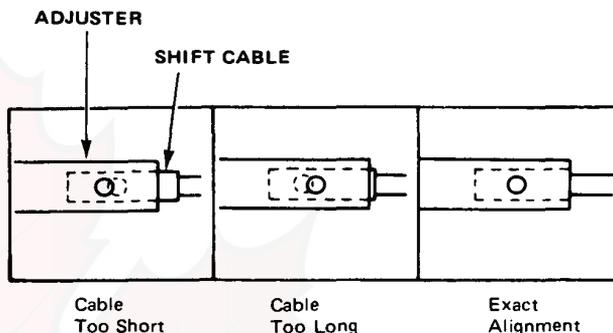

NOTE: There are two holes in the end of the shift cable. They are positioned 90° apart to allow cable adjustments in 1/4 turn increments.

5. If not perfectly aligned, loosen the lock nut on shift cable and adjust as required.
6. Tighten the lock nut.
7. Install the lock pin on the adjuster.

NOTE: If you feel the lock pin binding as you reinstall it, the cable is still out of adjustment and must be readjusted.

8. Start the engine and check the shift lever in all gears. If any gear does not work properly, refer to troubleshooting.

Shift Indicator Panel

Adjustment

1. Check that the index mark of the indicator aligns with the N mark of the shift indicator panel with the transmission in NEUTRAL.
2. If not aligned, remove the panel mounting screws and adjust by moving the panel.

NOTE: Whenever the escutcheon is removed for indicator bulb replacement etc., reinstall the panel as described above.

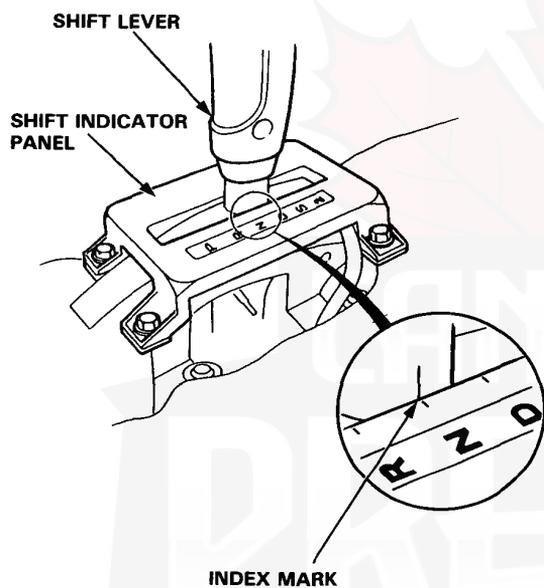

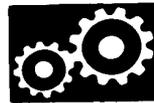

Throttle Control Cable

Adjustment/Inspection

NOTE: Before adjusting the throttle control cable, make sure:

- The throttle cable free play is correct.
- The engine is at normal operating temperature (cooling fan comes on).
- The idle speed is correct.
- On carbureted cars the distance between the throttle control lever and the throttle control bracket is correct (See "Throttle Control Cable Bracket Adjustment.")

Inspection:

NOTE: On carbureted cars, you will need an assistant to depress the accelerator pedal, on fuel-injected cars, you can work the throttle linkage body with your hand.

1. Remove the throttle cable free play.
2. On carbureted cars, disconnect the #6 vacuum hose from the throttle controller and connect a vacuum pump to the controller and apply vacuum.

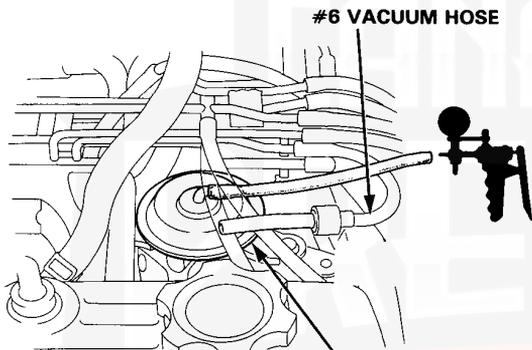

3. Apply light thumb pressure to the throttle control lever, then work the accelerator or throttle linkage. The lever should move just as the engine speed increases above idle. If not, proceed to Adjustment.

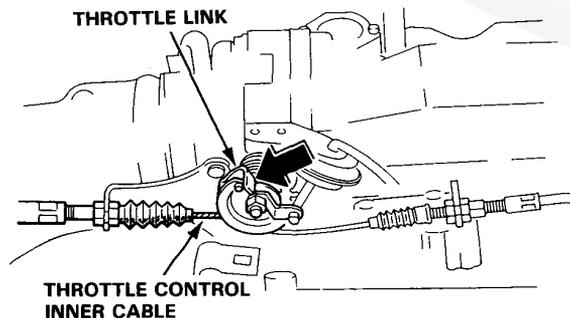

Adjustment:

1. Loosen the nuts on the control cable at the transmission end and synchronize the control lever to the throttle.

NOTE: To tailor the shift/lock-up characteristics to a particular customer's driving expectations, you can adjust the control cable up to 3 mm shorter than the "synchronized" point.

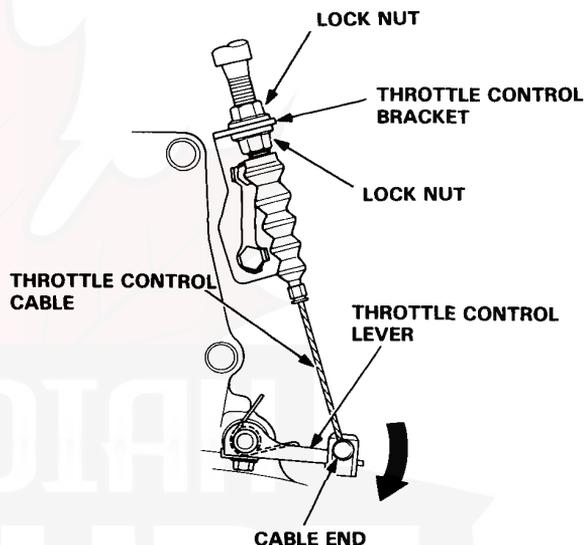

Differential

Special Tools	9-116
Illustrated Index	9-117
Backlash Inspection	9-118
Bearing Replacement	9-118
Taper Roller Bearing Preload Adjustment	9-119
Oil Seal Installation	9-121

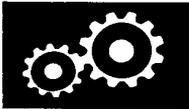

Special Tools

Special Tools

Ref. No.	Tool Number	Description	Q'ty	Remarks
①	07HAJ-PK40201	Preload Inspection Tool	1	
②	07JAD-PH80400	Pilot Driver 28 x 30 mm	1	
③	07LAD-PW50600	Bearing Driver Attachment 40/50 mm	1	
④	07749-0010000	Driver	1	
⑤	07JAD-PH80101	Seal Driver Attachment	1	
⑥	07947-6110501	Seal Driver Attachment	1	

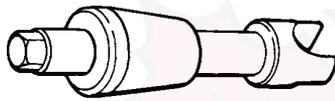

①



②

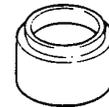

③



④

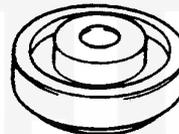

⑤



⑥

Differential

Illustrated Index

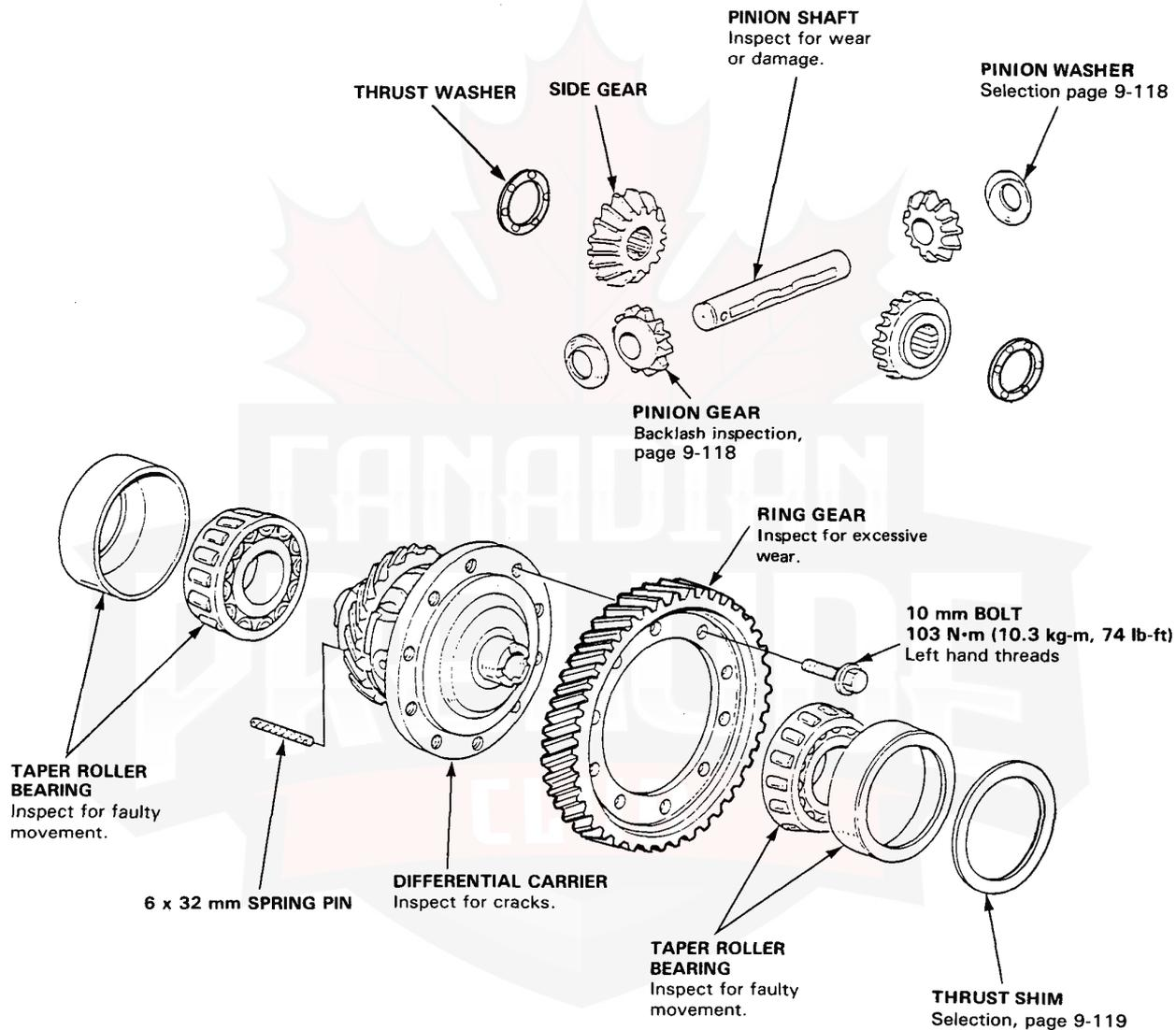
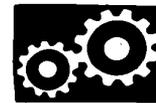

Differential

Backlash Inspection

1. Place differential assembly on V-blocks and install both axles.
2. Check backlash of both side gears.

Standard (New): 0.05–0.15 mm
(0.002–0.006 in.)

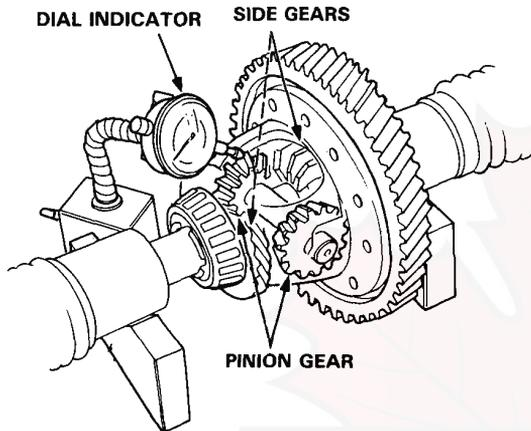

3. If out of tolerance, disassemble differential and select new pinion washers from the table below.

	PART NUMBER	THICKNESS
A	41351-PG1-000	0.70 mm (0.028 in.)
B	41352-PG1-000	0.75 mm (0.030 in.)
C	41353-PG1-000	0.80 mm (0.031 in.)
D	41354-PG1-000	0.85 mm (0.033 in.)
E	41355-PG1-000	0.90 mm (0.035 in.)
F	41356-PG1-000	0.95 mm (0.037 in.)
G	41357-PG1-000	1.00 mm (0.039 in.)
H	41358-PG1-000	1.05 mm (0.041 in.)

Bearing Replacement

NOTE: Check bearings for wear and rough rotation. If bearings are OK, removal is not necessary.

1. Remove bearings using a standard bearing puller.

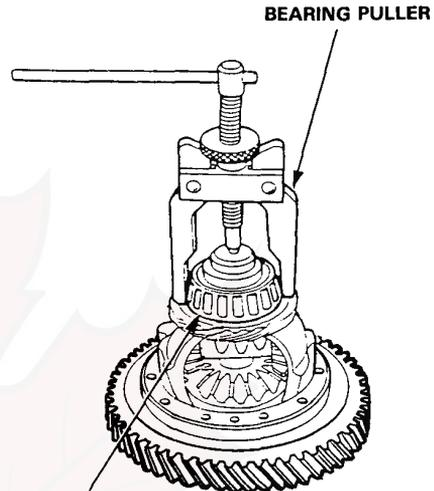

2. Using a press and the special tool, install new bearings.

NOTE: Drive in the bearings until they fully bottom.

NOTE:

- Drive in the bearings until they fully bottom.
- The bearing and outer race should be replaced as a pair.
- Inspect the adjust the bearing preload whenever the bearing is replaced.
- Drive in the bearings securely so that there is no clearance between the bearings and differential carrier.

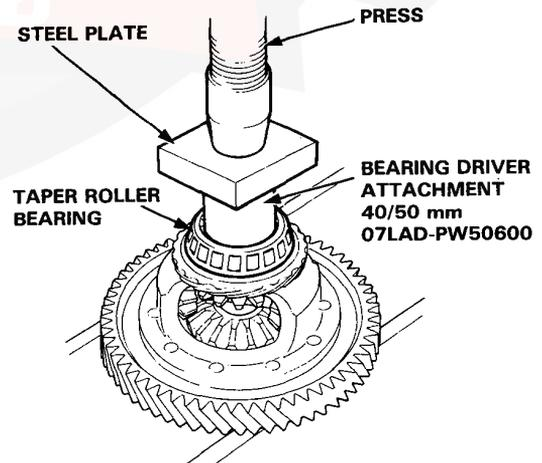



Taper Roller Bearing Preload Adjustment

NOTE: If the transmission housing, torque converter housing, differential case, bearing, outer race or thrust shim were replaced, the bearing preload must be adjusted.

1. Remove the bearing outer race and thrust shim from the transmission housing by prying or remove the outer race from the transmission housing by heating the housing to about 100°C (212°F) with a heat gun.

CAUTION:

- Do not heat the case in excess of 100°C (212°F).
- Replace the thrust shim with a new one if it is pried out.
- Replace the bearing when the outer race is to be replaced.
- Do not use shim on the torque converter housing side.

NOTE: Let the transmission housing cool to the room temperature before adjusting the bearing preload.

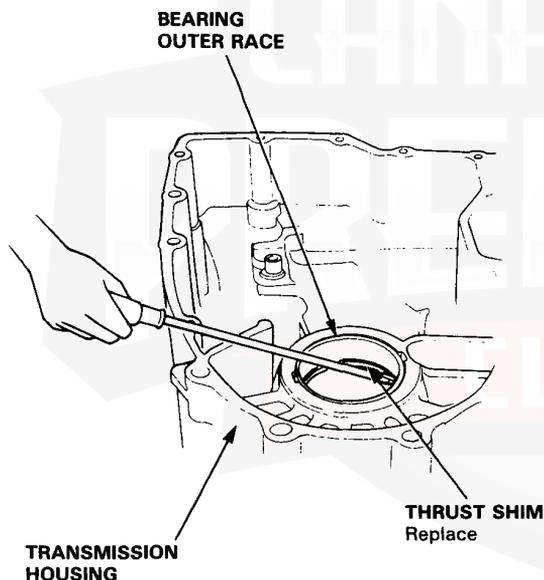

2. Select the thrust shim from the table below so that their total thickness is 2.60 mm (0.102 in).

CAUTION: Do not use more than two shims to adjust the bearing preload.

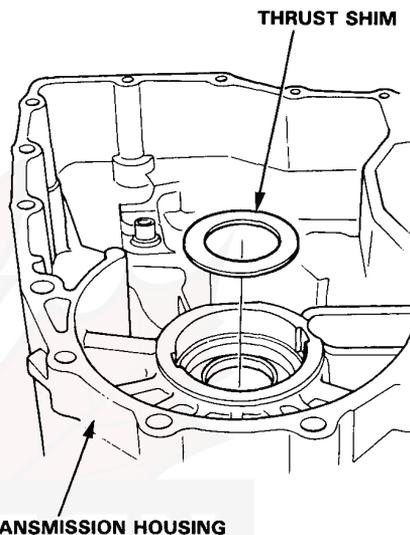

3. Thrust Shim Table

	PART NUMBER	THICKNESS
A	41441-PK4-000	2.20 mm (0.087 in)
B	41442-PK4-000	2.25 mm (0.089 in)
C	41443-PK4-000	2.30 mm (0.091 in)
D	41444-PK4-000	2.35 mm (0.093 in)
E	41445-PK4-000	2.40 mm (0.094 in)
F	41446-PK4-000	2.45 mm (0.096 in)
G	41447-PK4-000	2.50 mm (0.098 in)
H	41448-PK4-000	2.55 mm (0.100 in)
*I	41449-PK4-000	2.60 mm (0.102 in)
J	41450-PK4-000	2.65 mm (0.104 in)
K	41451-PK4-000	2.70 mm (0.106 in)
L	41452-PK4-000	2.75 mm (0.108 in)
M	41453-PK4-000	2.80 mm (0.110 in)
N	41454-PK4-000	2.85 mm (0.112 in)
O	41455-PK4-000	2.90 mm (0.114 in)
P	41456-PK4-000	2.95 mm (0.116 in)
Q	41457-PK4-000	3.00 mm (0.118 in)
R	41458-PK4-000	3.05 mm (0.120 in)

* Standard shim

(cont'd)

Differential

Taper Roller Bearing Preload Adjustment (cont'd)

4. After installing shims, install the outer race in the transmission housing.

CAUTION:

- Install the outer race squarely in the transmission housing.
- Check that there is no clearance between the outer race, shim and transmission housing.
- Install gasket when checking preload.

5. With the mainshaft and countershaft removed, install the differential assembly and torque the transmission housing.

TORQUE: 55 N·m (5.5 kg·m, 40 lb·ft)

6. Rotate the differential assembly in both directions to seat the bearings.
7. Measure the starting torque of the differential assembly with the Preload Inspection Tool and a torque wrench.

STANDARDS:

New bearings: 2.8–4.0 N·m
(28–40 kg·cm, 24–35 lb·in)

Reuse bearings: 2.5–3.7 N·m
(25–37 kg·cm, 22–32 lb·in)

NOTE:

- Measure the preload at normal room temperature in both direction.
- If out of specs, select two shims which will give the correct preload, and repeat steps 1-7.

NOTE: Changing one of the shims to the next size will increase or decrease preload about 3–4 kg·cm (2.60–3.47 lb·in).

8. To increase the starting torque, increase the thickness of shims. To decrease the starting torque, decrease the thickness of shims.

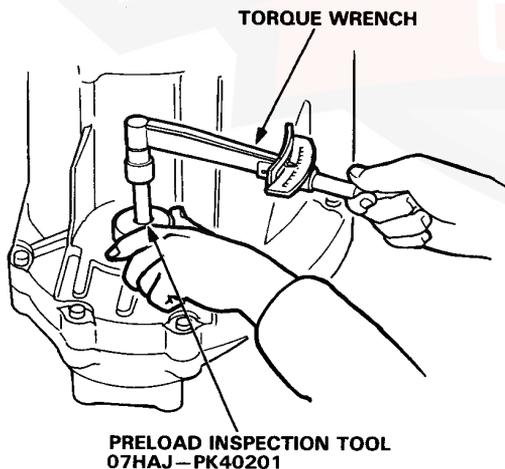

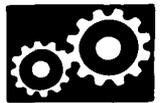

Oil Seal Installation

1. Install the oil seal in the transmission housing.

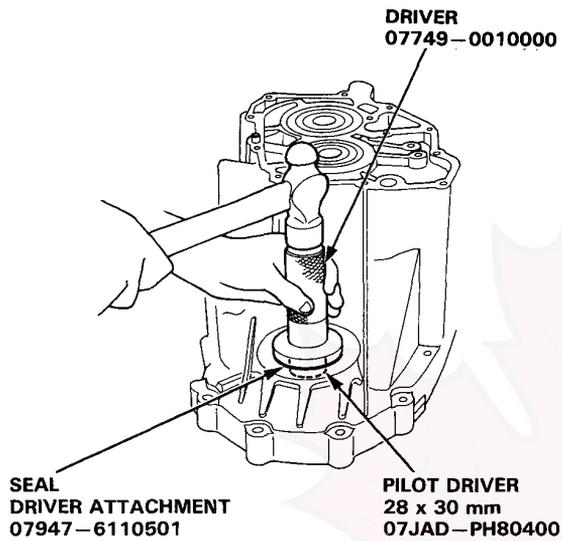

2. Drive the oil seal into the torque converter housing.

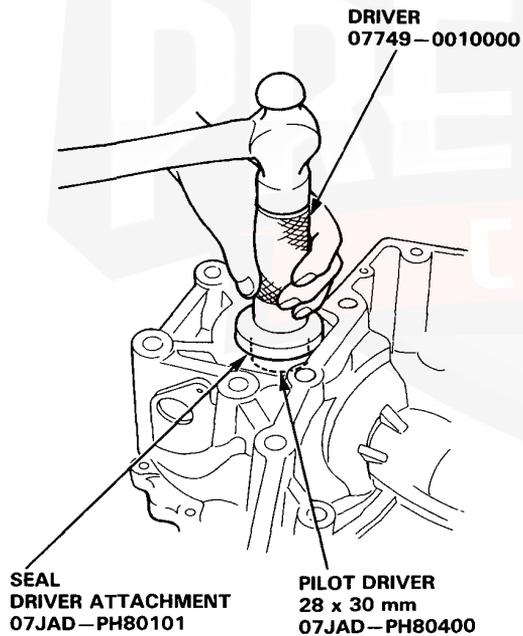

Power Steering

Steering Gearbox

Steering Gearbox Overhaul (2WS) ... 11-2

Steering Gearbox Overhaul (4WS) ... 11-3

Rear Steering Gearbox (4WS)

Illustrated Index 11-4

Tie-rod Replacement 11-5



Outline of Model Changes

- The boot bands of the front steering gearbox have been changed.
- The boot bands of the rear steering gearbox (4WS) have been changed.
- The torque value of the rear steering joint (4WS) has been changed.

Steering Gearbox

Overhaul (2WS)

1. Install the boots so that the angle of the pinion shaft center line is as shown.
2. Install new boot bands on the boot and bend both sets of locking tabs.

NOTE: LR Drive shown, RH Drive is symmetrically.

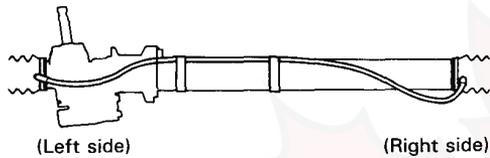

3. Lightly tap on the doubled-over portions to reduce their height.

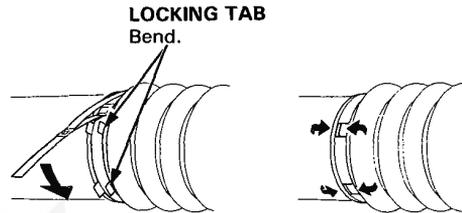

4. Install the air transfer tube.
5. After assembling, slide the rack right and left to be certain that the boots are not deformed or twisted.

<GEAR HOUSING SIDE>

View from the left side.

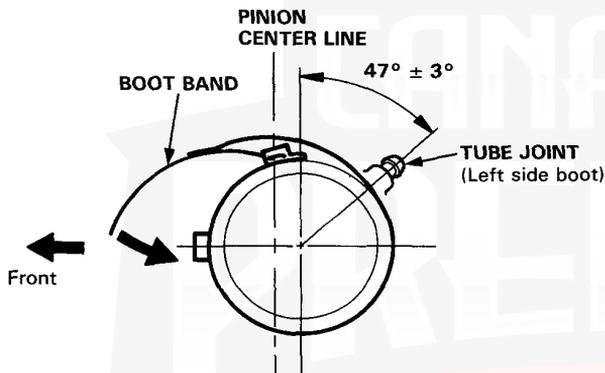

<CYLINDER SIDE>

View from the right side.

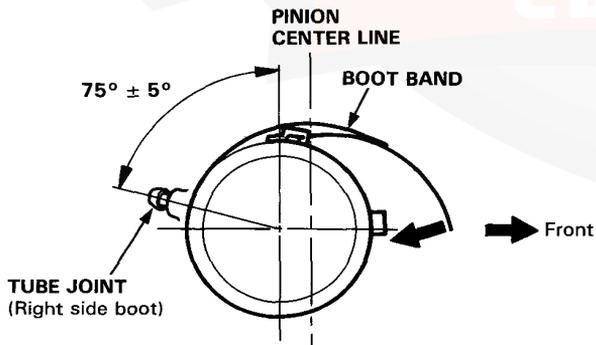

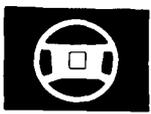

Overhaul (4WS)

NOTE: LH Drive shown, RH Drive is symmetrically.

1. Install the dust seal and position the new boot band, then bend both sets of the locking tabs.
2. Lightly tap on the doubled-over portions to reduce their height.

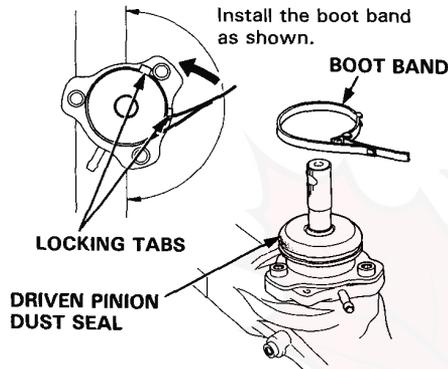

3. Install the transfer tube clips as shown.

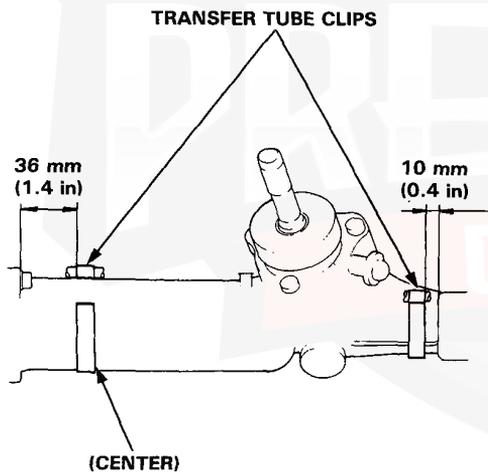

NOTE: LH Drive shown, RH Drive is symmetrically.

4. Install new boot bands on the boot and bend both sets of locking tabs.

NOTE: Install the boots so that the angle of the drive pinion center line is as shown. LH Drive shown RH Drive is symmetrically.

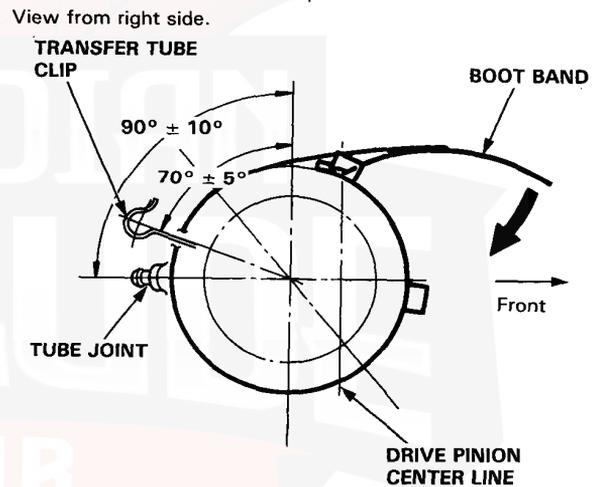
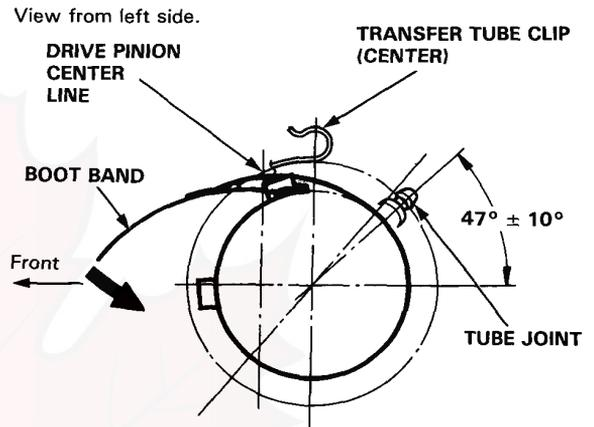

5. Lightly tap on the doubled-over portions to reduce their height.

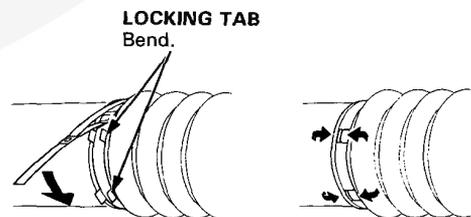

6. Install the air transfer tube.
7. After assembling, slide the rack right and left to be certain that the boots are not deformed or twisted.

Rear Steering Gearbox

Illustrated Index

CAUTION:

1. Do not apply torque of more than 0.1 kg-m (0.72 lb-ft) to the offset shaft.
2. Do not strike the stroke rod.
3. Never loosen the offset shaft screw and lock nut screw.
4. Do not remove the gearbox cover.
5. Use the special tool "Rear Steering Gearbox Center Lock Pin" when removing the rear steering gearbox, and leave it intact except when the gearbox is inspected for function, etc.
6. Also use the special tool "Rear Steering Gearbox Center Lock Pin" when removing the front or rear of the center shaft.

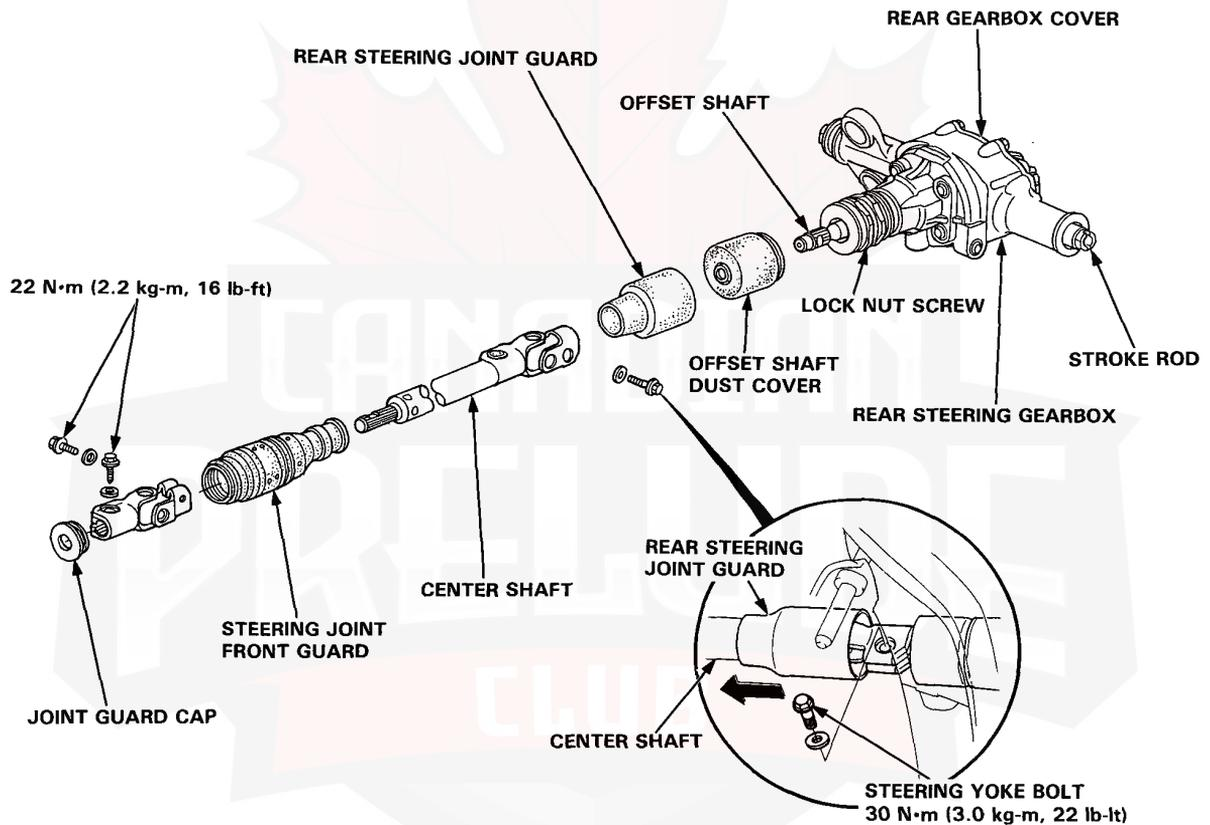



Tie-rod Replacement

Boot installation:

1. Install new boot bands on the boot and bend both sets of locking tabs.
2. Lightly tap on the doubled-over portions to reduce their height.

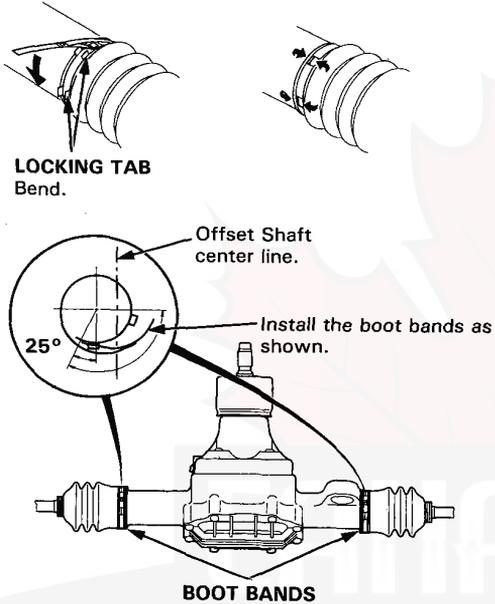

NOTE: After installing the boot band, check that the boots are not twisted or distorted.

Air Conditioner

Illustrated Index	15-2	System Charging	
Wire Harness Routing	15-4	System Evacuation	15-36
Wiring Diagram	15-6	Leak Test	15-37
Compressor Control System		Charging Procedure	15-38
Description	15-8	Supplement	15-39
Input Tests	15-9		
Troubleshooting Flow Chart	15-10	Performance Test	15-40
Service Tips	15-20		
Evaporator		Test	
Replacement	15-22	Evaporator Sensor	15-41
Overhaul	15-23	Relay	15-41
Condenser Replacement	15-24	A/C Switch	15-42
		Blower Fan Switch	15-42
Compressor (Matsushita)			
Description	15-25		
Troubleshooting	15-26		
Replacement	15-27		
Belt Adjustment	15-29		
Clutch Inspection	15-30		
Thermal Protector Inspection	15-31		
Pick-up Sensor Inspection	15-31		
Thermal Protector/Pick-up Sensor			
Replacement	15-31		
Clutch Overhaul	15-32		
Shaft Seal Replacement	15-34		
Relief Valve Replacement	15-35		

Outline of Model Changes

- Pressure plate and dust seal of the compressor have been changed.
- "System charging" has been changed to minimize the release of chlorofluorocarbons as the refrigerant.

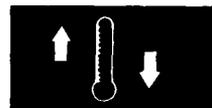

Illustrated Index

<LHD>

Refrigerant capacity: 900 \pm 50 g (1.98 \pm 0.11 lbs)

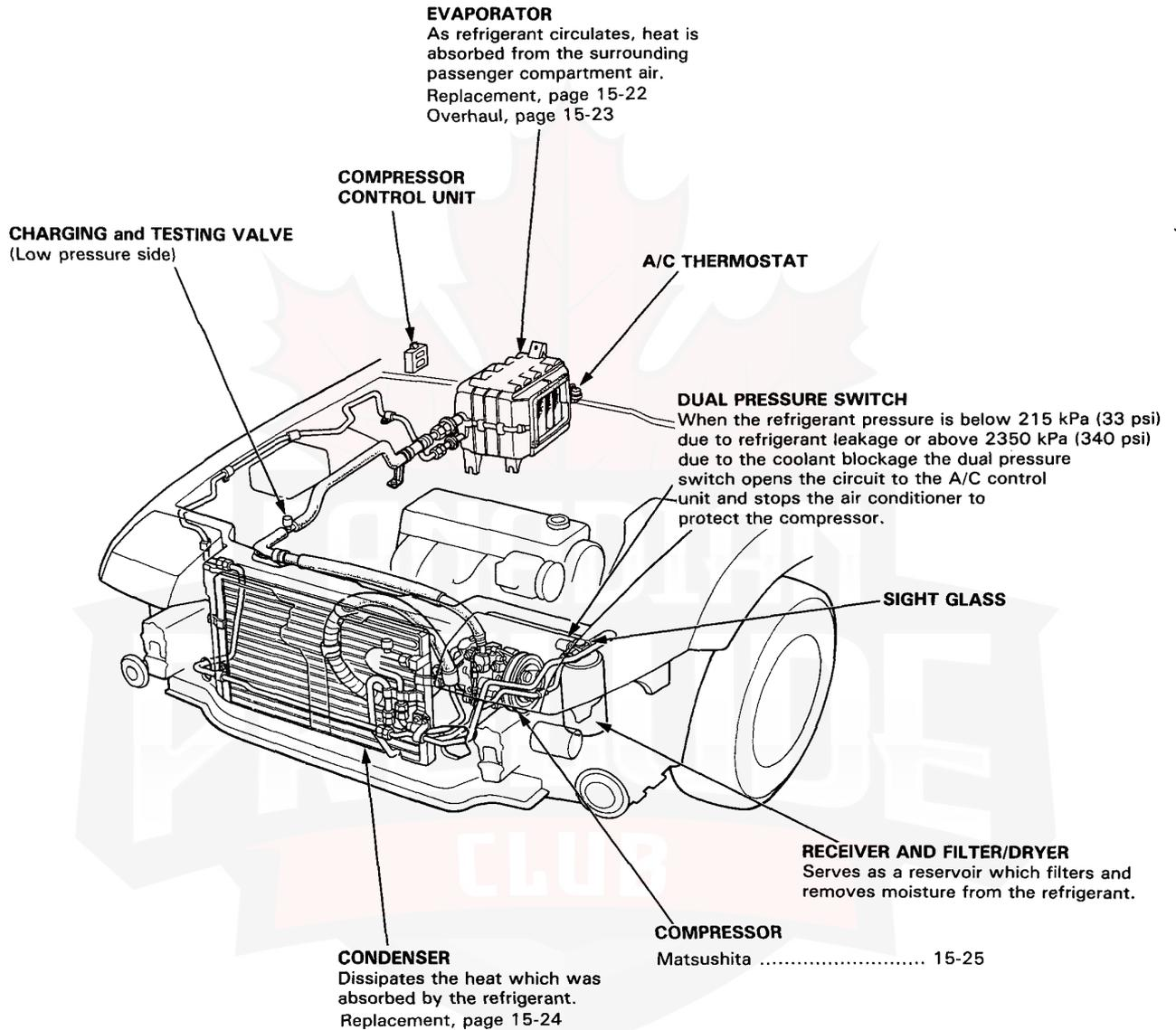



<RHD>

Refrigerant capacity: 800 \pm 50 g (1.76 \pm 0.11 lbs)

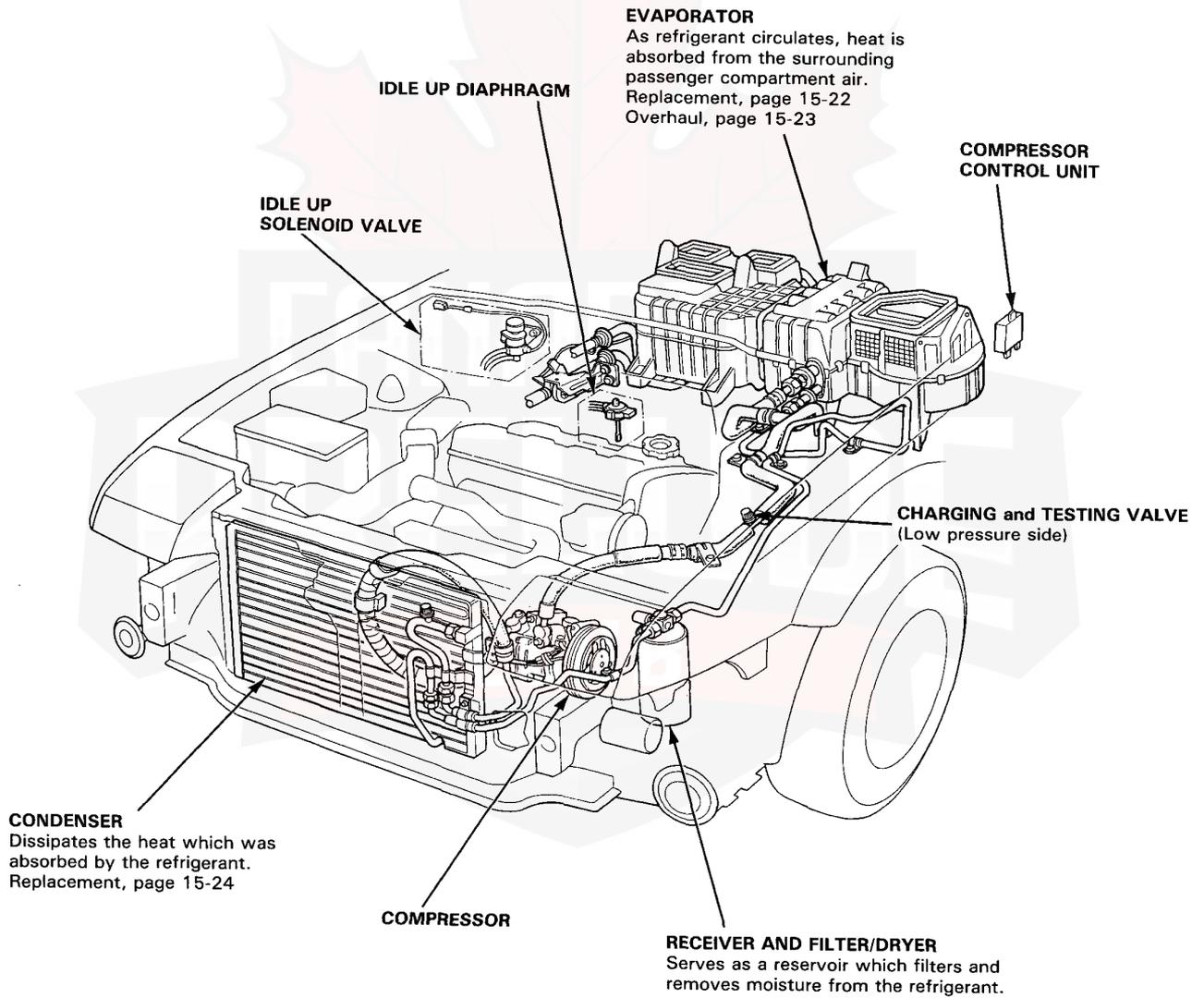

Wire Harness Routing

FUEL INJECTED:

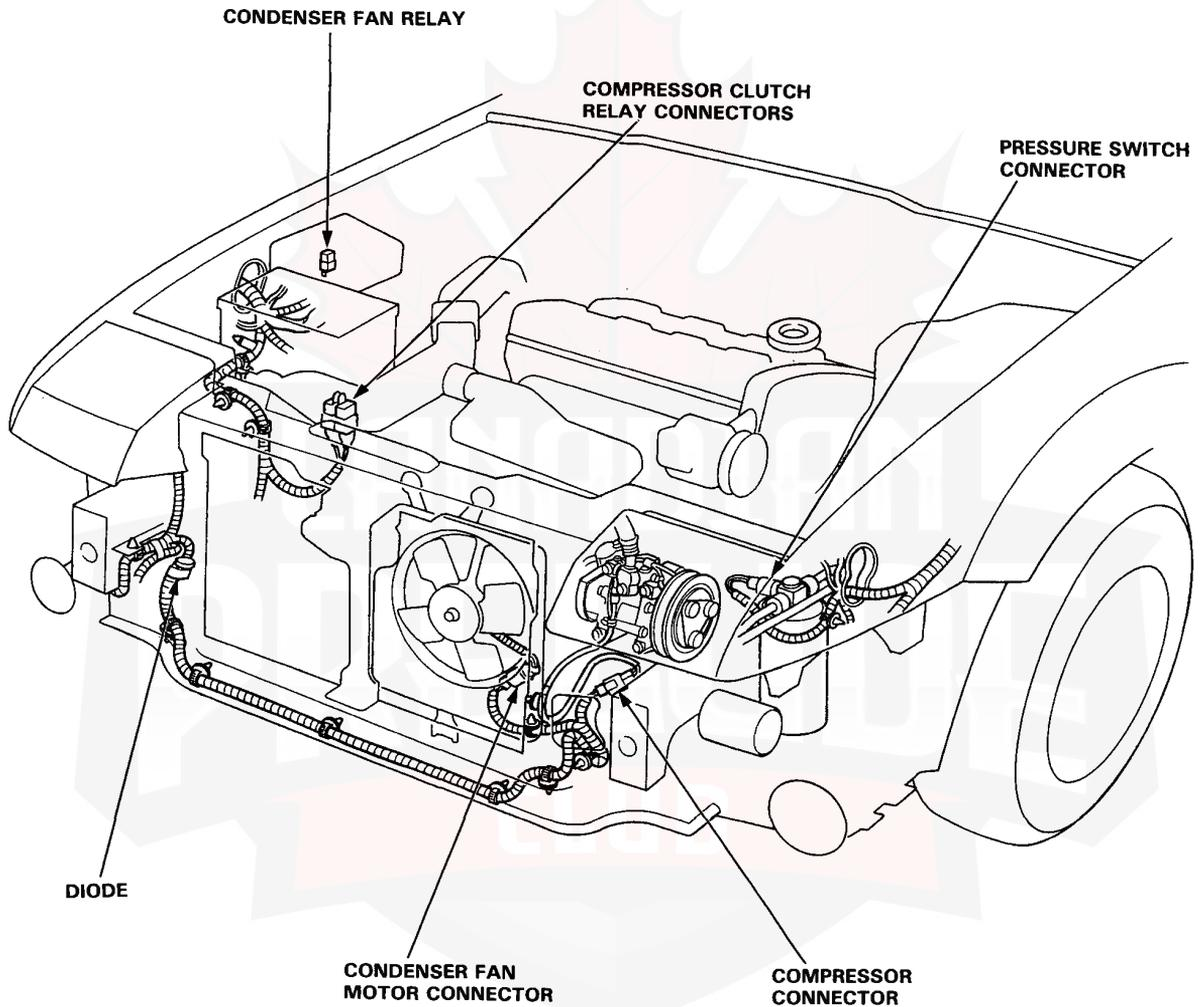



CARBURETED:

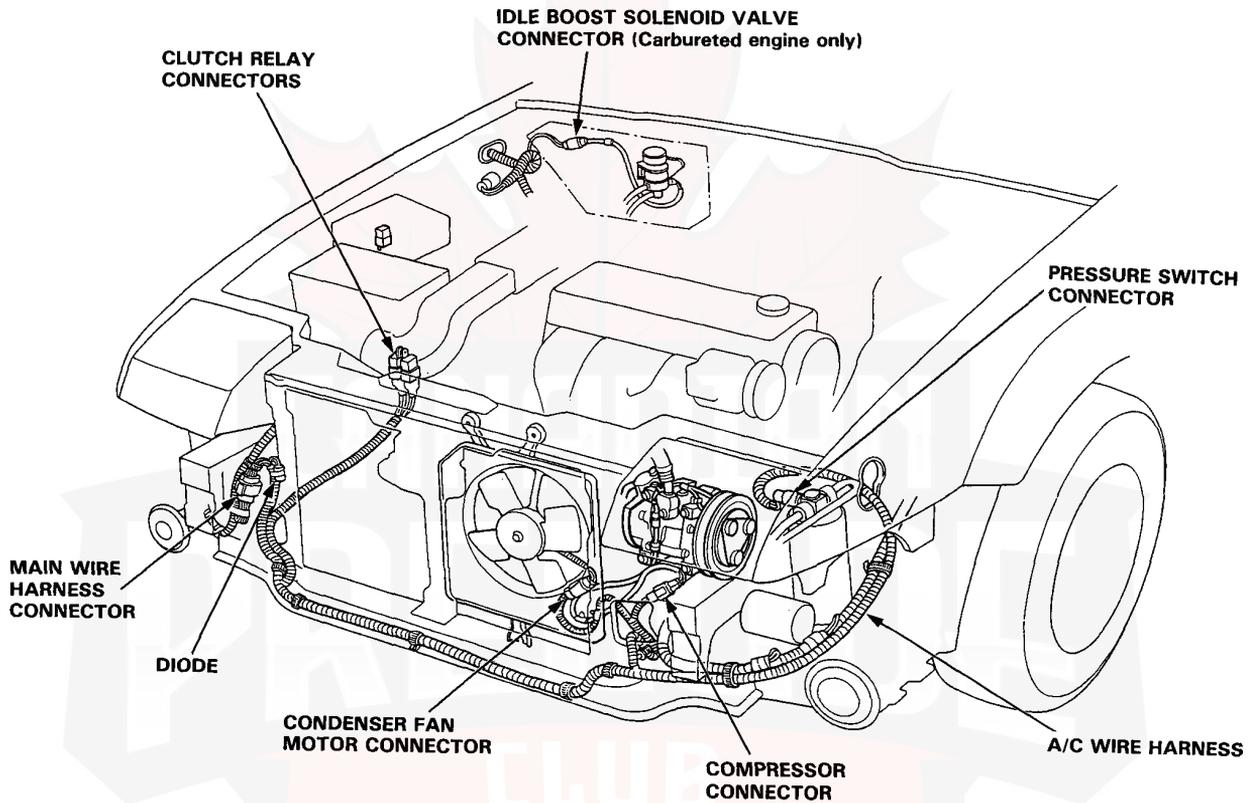

Air Conditioner

Wiring Diagram

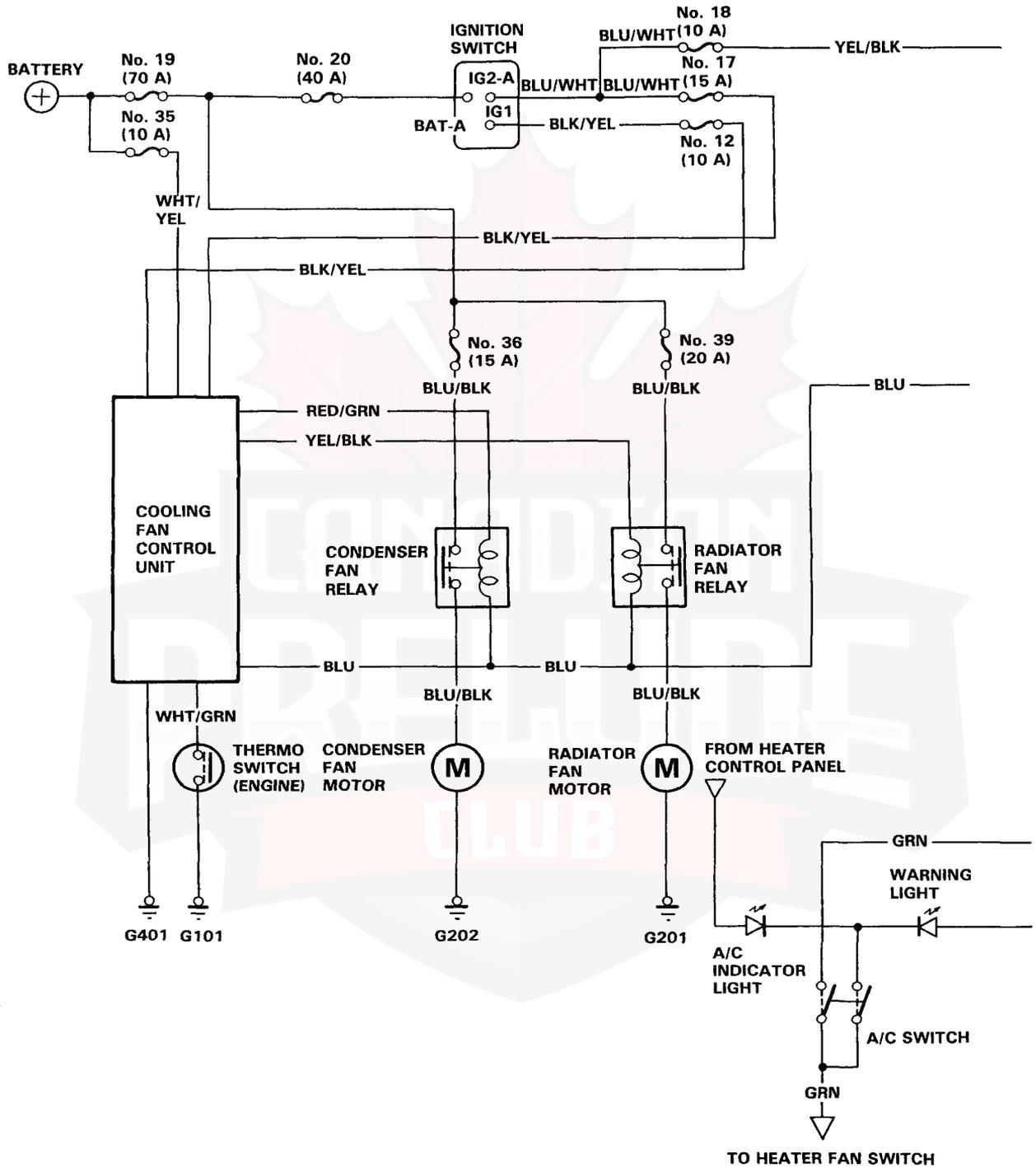

Compressor Control System

Description

The compressor control unit has a system designed to protect the compressor belt in the event of a seizure, thereby allowing the alternator to continue operating.

This is done by comparing the engine rpm and the compressor pulley rpm. When there is a difference in rpm that continues for more than 3 seconds, the compressor relays are turned off and the warning light comes on.

To reset, push the A/C switch off, then push it on again.

NOTE: If the switch is pushed off and on more than twice, it will be necessary to turn off the ignition to reset.

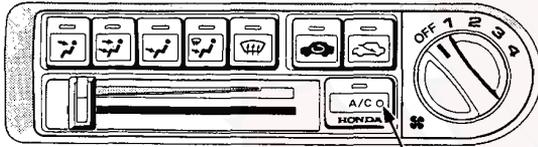

WARNING LIGHT

NOTE: This doesn't show on late model Prelude unless illuminated.

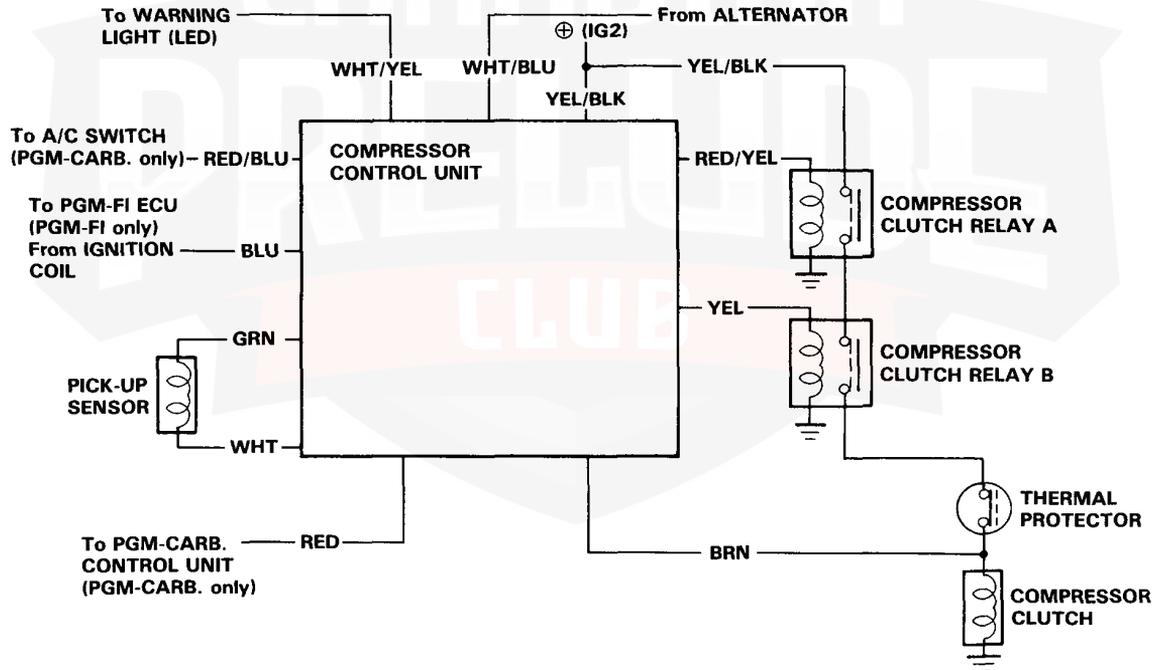

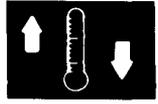

Input Tests

NOTE:

- Make sure all connectors are clean and tight.
- Make all tests from the wire side of the connector with a digital multi-tester.
- Any abnormality found during these tests must be corrected before continuing.
- If all tests produce the desired results, substitute a known-good control unit and retest.

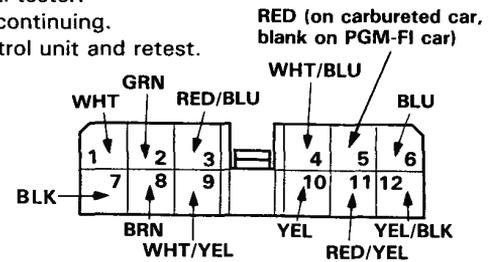

View from wire side.

Perform the following tests with the A/C control unit's 12P connector disconnected, and the ignition switch, blower switch, and A/C switch ON.

WIRE POSITION	CIRCUIT	TEST CONDITION	DESIRED RESULTS	CORRECTIVE ACTION IF DESIRED RESULTS AREN'T OBTAINED
BLK (7)	Ground	Check for continuity to body ground.	Should have continuity.	Repair open to body ground.
YEL/BLK (12)	Power	Check for battery voltage.	Should have battery voltage.	Check #18 fuse; if OK, repair open in YEL/BLK wire.
RED/YEL (11) and YEL (10)	Compressor relay A Compressor relay B	Connect both the RED/YEL (11) and YEL (10) wires to the YEL/BLK (12) wire with jumper wires.	The A/C compressor clutch should click.	Check for an open or short in the RED/YEL or YEL wires.
BLU (6)	Engine speed	Check for battery voltage.	Should have battery voltage.	Check for an open or short in the BLU wire or a faulty coil.
GRN (2) and WHT (1)	Compressor sensor	Check resistance between the GRN and WHT wires (use 20 K scale).	Should be approximately 0.45 to 0.60 ohms on the 20 K scale (450–600 ohms).	Check for open in GRN or WHT wires between the A/C control unit and the compressor pick-up sensor or a faulty pick-up sensor.
BRN (8)	Compressor clutch	Check resistance to body ground.	Should be approximately 4 ohms.	Check for an open in the BRN wire between the A/C control unit and the compressor clutch coil or a faulty compressor clutch.

Perform the following tests with A/C control unit connected, engine running and the A/C system turned ON.

RED/YEL (11)	Compressor relay A	Check for battery voltage.	Should have battery voltage.	Check the connection to the A/C control unit; if OK, substitute a known-good control unit and retest.
YEL (10)	Compressor relay B	Check for battery voltage.	Should have battery voltage.	Check the connection to the A/C control unit; if OK, substitute a known-good control unit and retest.
BRN (8)	Thermal protector	Check for system voltage.	Should have system voltage.	Test thermal protector.

Troubleshooting

- Any abnormality must be corrected before continuing to the next test.
- Because of the precise measurements needed, use a digital voltmeter and ohmmeter when testing.

Before performing any troubleshooting procedures check:

- Fuses No. 18, 36, 39, 17, 12, 35, 20
- Grounds No. G201, G401, G202, G203
- All electrical connections are clean and tight.

FLOW CHART NO.	SYMPTOM	PAGE
1	A/C compressor warning light comes ON.	15-11
2	Compressor, warning light and cooling fans do not come on.	15-12
3	A/C compressor does not come on and cooling fans come on.	15-14
4	Both fans (condenser and compressor fans) do not run. Compressor operates normally.	15-16
5	One fan (condenser or compressor fan) does not run. Compressor operates normally.	15-19

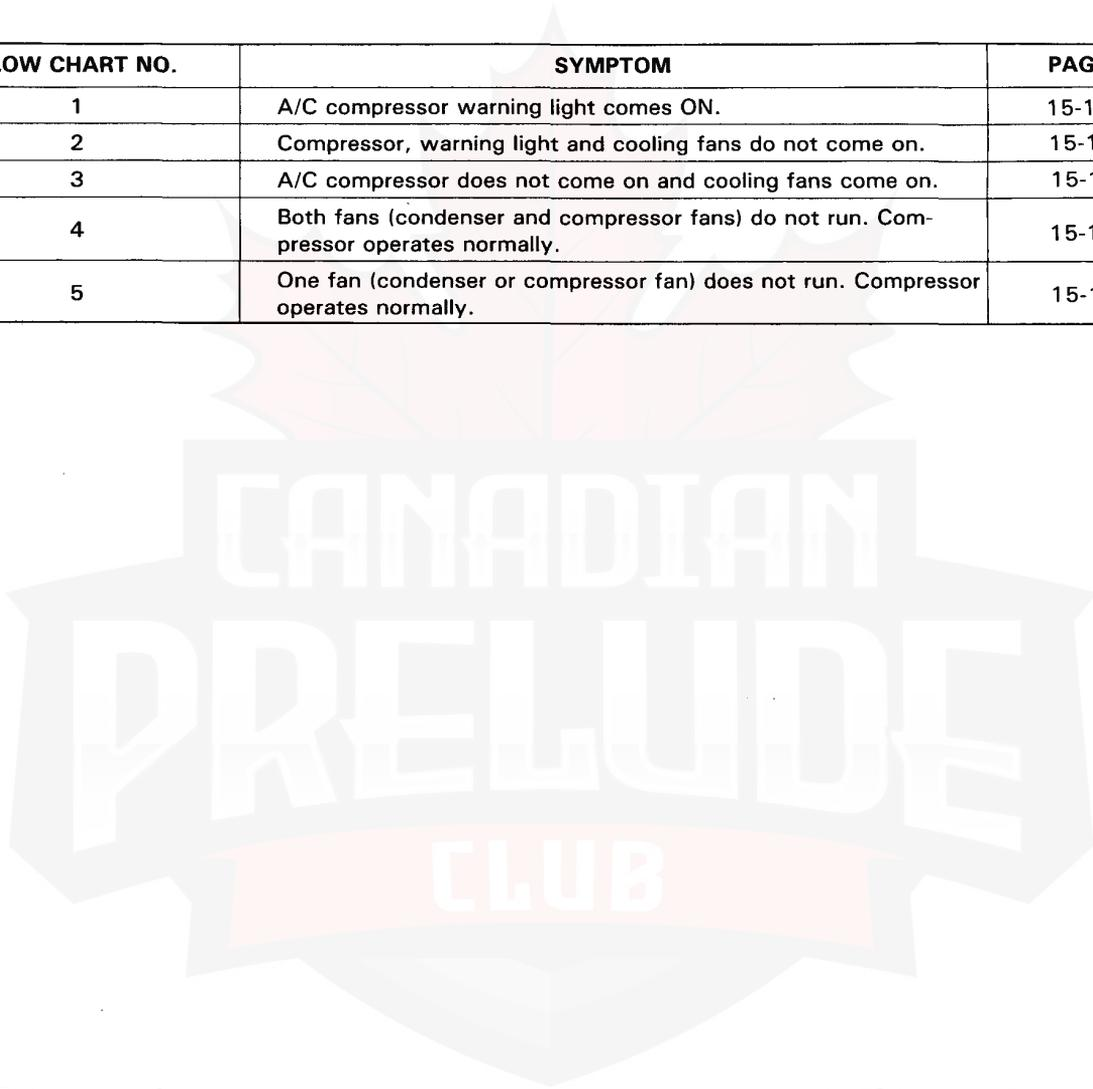

NOTE: To improve performance, when the throttle is opened quickly, the signal from the ECU to the A/C compressor is interrupted for 4–6 seconds.

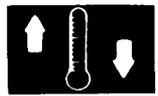

Flow Chart 1

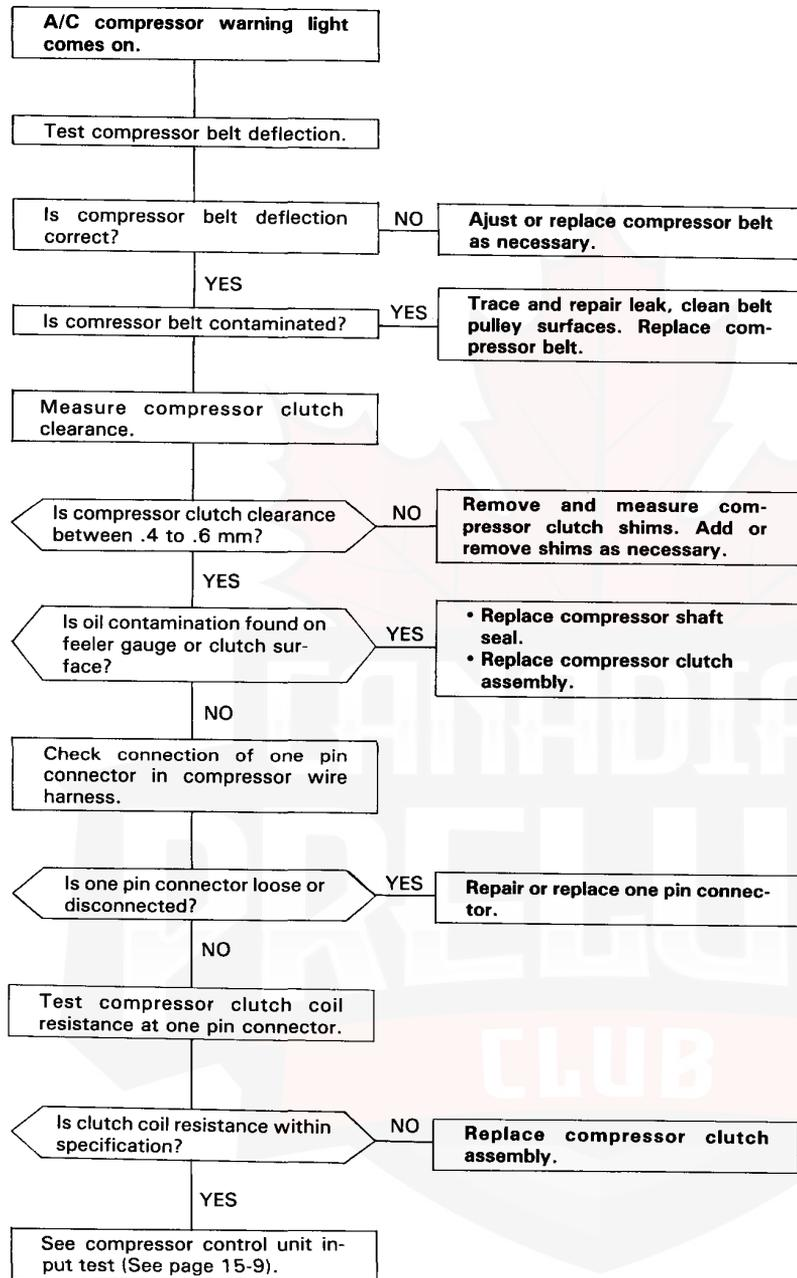

Troubleshooting

Flow Chart 2

NOTE: Perform all checks with the engine running.

Compressor, warning light and cooling fans do not come on.

Disconnect the dual pressure switch.

Connect a jumper wire between BLU/RED terminal and body ground.

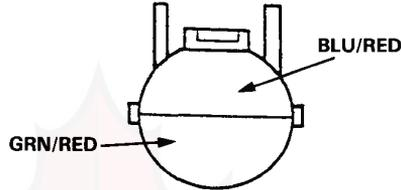

Does the A/C system (compressor and cooling fans) come on?

NO

Repair open in BLU/RED wire between A/C diodes and dual pressure switch.

YES

Connect a jumper wire between BLU/RED and GRN/RED terminals.

Does the A/C system come on?

YES

Check the A/C pressure; if OK, replace the dual pressure switch.

NO

Reconnect the dual pressure switch and disconnect evaporator sensor connector.

Connect a jumper wire between GRN/RED terminal and body ground.

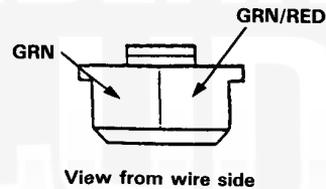

Does the A/C system come on?

NO

Repair open in GRN/RED wire between A/C dual pressure switch and body ground.

YES

Connect a jumper wire between GRN/RED and GRN terminals.

Does the A/C system come on?

YES

Replace the evaporator sensor.

NO

Reconnect the evaporator sensor.

(Continued on next page)



(Continued from previous page)

Disconnect the heater control panel and connect a jumper wire between GRN (1) terminal and body ground.

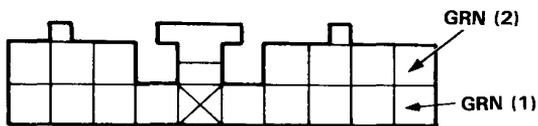

View from wire side

Does the A/C system come on?

NO

Repair open in GRN (1) wire between the evaporator sensor and the heater control panel.

YES

Connect a jumper wire between GRN (1) and BLK terminals.

Does the A/C system come on?

NO

Repair open in BLK wire between the heater control panel and body ground.

YES

Reconnect the control panel.

Remove A/C switch and connector.

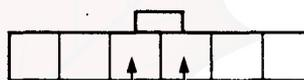

view from wire side

With switch connected, ground the BLU wire.

Does A/C system come on?

NO

Replace the heater control panel.

YES

Turn on A/C switch and ground the ORN wire.

Does A/C system come on?

NO

Replace the A/C switch.

YES

Ground GRN (2) at heater control connector.

Does A/C system come on?

NO

Replace the heater control panel.

YES

- Check connection of GRN wire to blower switch.
- Test blower switch.

Troubleshooting

Flow Chart 3

A/C compressor does not come on and cooling fans come on.

Disconnect A/C compressor clutch relays A and B.

Measure voltage between the YEL/BLK terminal (+) and body ground.

Is there battery voltage?

NO

Repair open in YEL/BLK wire between relay and fuse box or a blown No. 18 fuse.

YES

Connect a jumper wire between YEL/BLK terminal on relay A and RED terminal on relay B.

Does the A/C compressor come on?

NO

Check the A/C compressor clutch or thermal protector, or an open in RED wire.

YES

Inspect the compressor clutch relays A and B.

Are the relays OK?

NO

Replace the relay(s).

YES

Check for continuity on the GRY terminal between relays A and B.

Is there continuity?

NO

Repair open GRY wire between relays A and B.

YES

Reconnect relays A and B and remove the A/C diodes (taped to wire harness under right headlight).

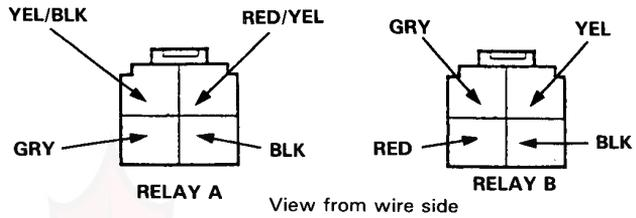

(Continued on next page)



(Continued from previous page)

Connect a jumper wire between the RED/BLU and BLU/RED wire terminals.

Does the compressor come on?

YES

Replace the A/C diodes.

NO

CHECK the CCU* inputs (page 15-9).

NOTE: Check the A/C signal (A/C CCU ↔ PGM-FI ECU, PGM-FI ECU ↔ A/C DIODES) (PGM-FI CAR ONLY) (See fuel and emission section)

*CCU: Compressor Control Unit

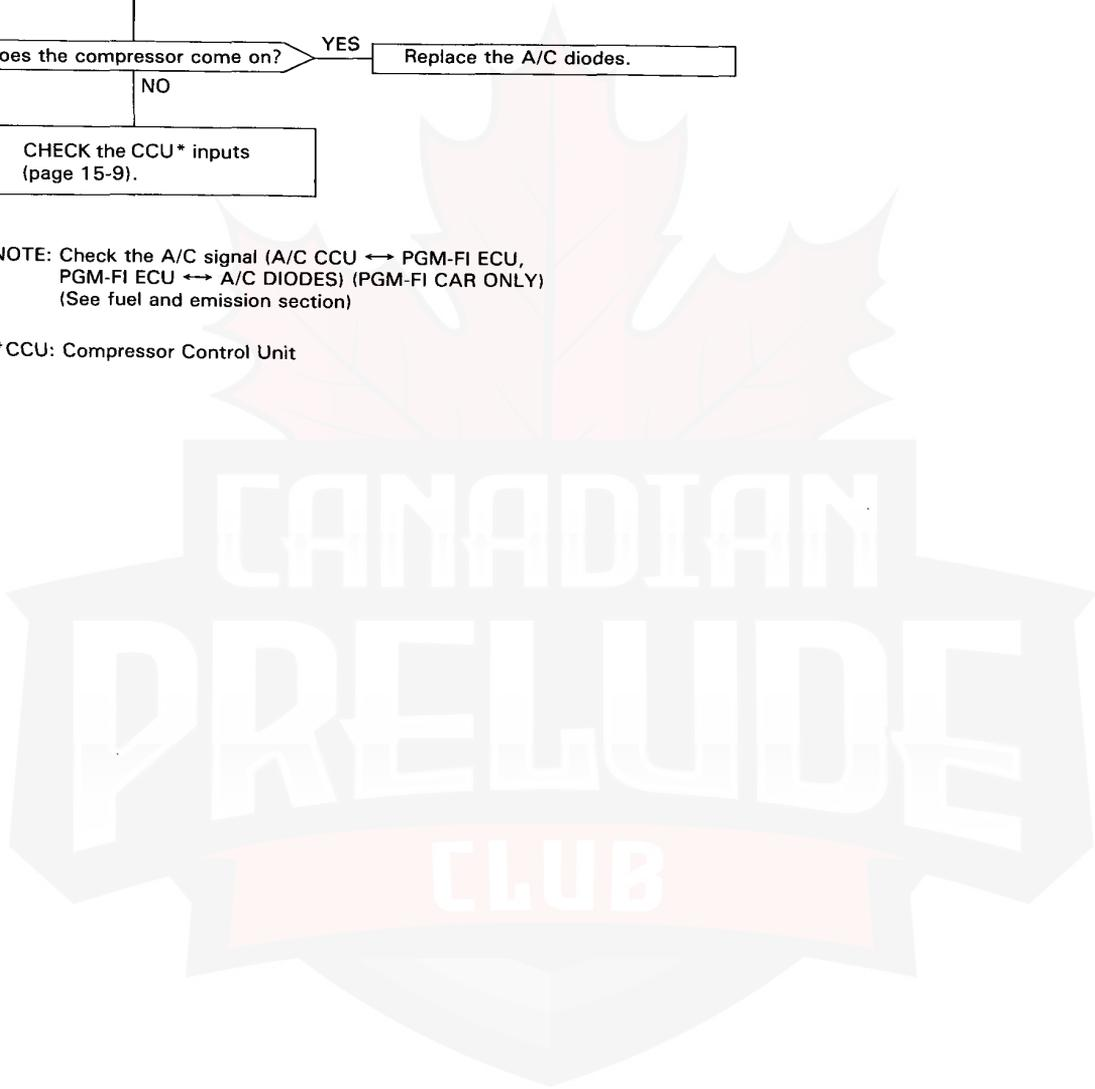

Troubleshooting

Flow Chart 4

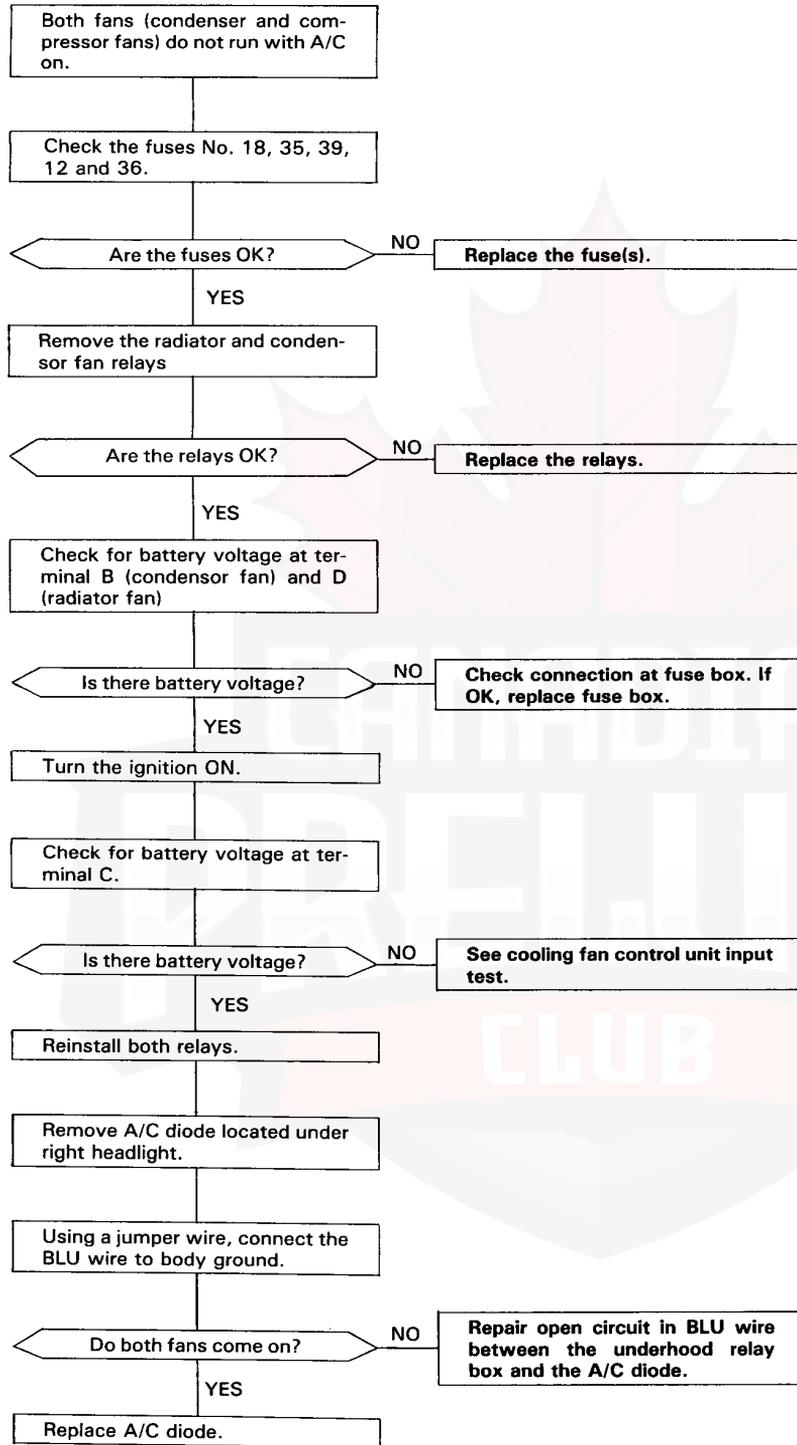

CONDENSER
FAN RELAY
SOCKET

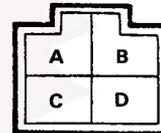

RADIATOR
FAN RELAY
SOCKET

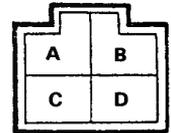

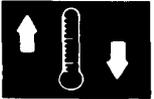

Cooling Fan Control Unit Input Test

- All test should be performed with the key "ON" (unless specified otherwise) and the cooling fan control unit unplugged (unless specified otherwise).
- All test are made from the wire side of the connector.
- Any abnormality must be corrected before continuing to the next test.

Before performing any troubleshooting procedures check:

- Fuses No. 17, 12, 36, 39, 35.
- All electrical connections are clean and tight.

NOTE: If all tests check OK, replace with known-good cooling fan control unit.

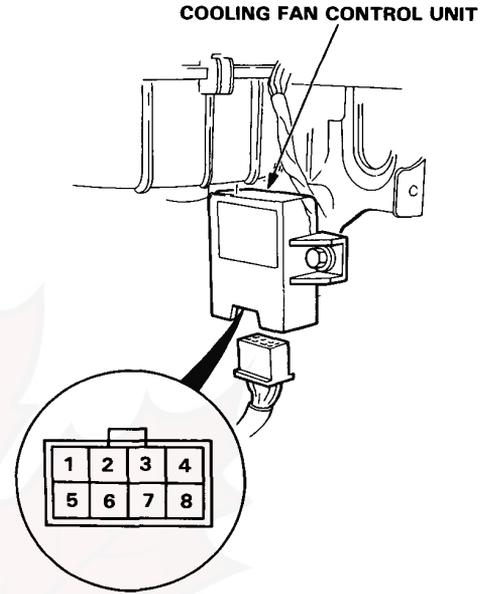

View from wire side

WIRE COLOR	TEST CONDITION	IF DESIRED RESULTS ARE NOT OBTAINED:
YEL/BLK	Connect to WHT/YEL using a jumper wire. Condenser fan should come on.	Repair open in YEL/BLK between cooling fan control unit and underhood relay box.
BLK/YEL ²	Check for battery voltage.	Repair open in BLK/YEL ² between fuse No. 17 and cooling fan control unit.
RED/GRN	Connect to WHT/YEL using a jumper wire. Radiator fan should come on.	Repair open in RED/GRN between cooling fan control unit and underhood relay box.
BLK	Check for continuity to ground.	Repair open circuit to body ground.
WHT/YEL	Check for battery voltage.	Repair open between fuse No. 35 and cooling fan control unit.
BLK/YEL ¹	Check for battery voltage.	Repair open in BLK/YEL ¹ between fuse No. 12 and cooling fan control unit.

Troubleshooting

Flow Chart 5

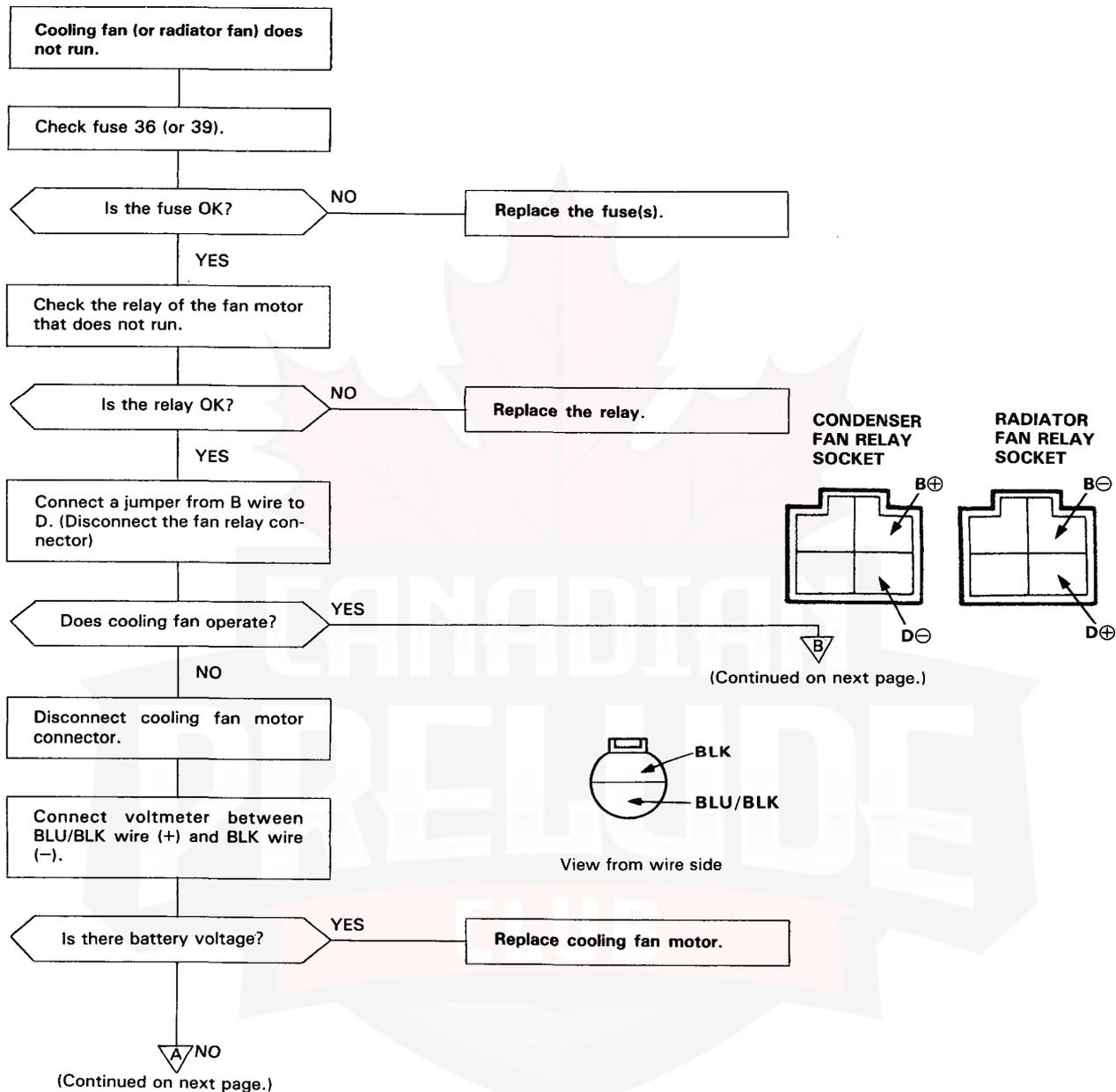

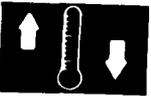

(Continued from previous page.)

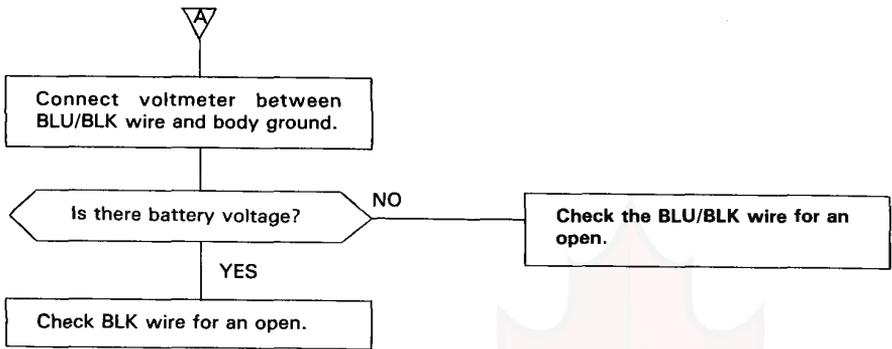

(Continued from previous page.)

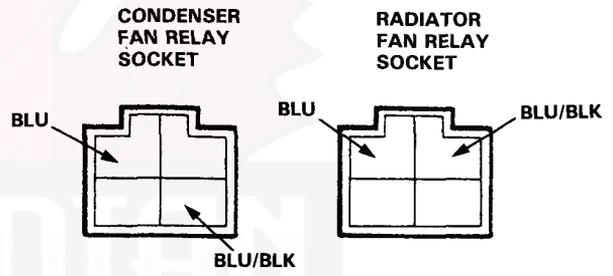
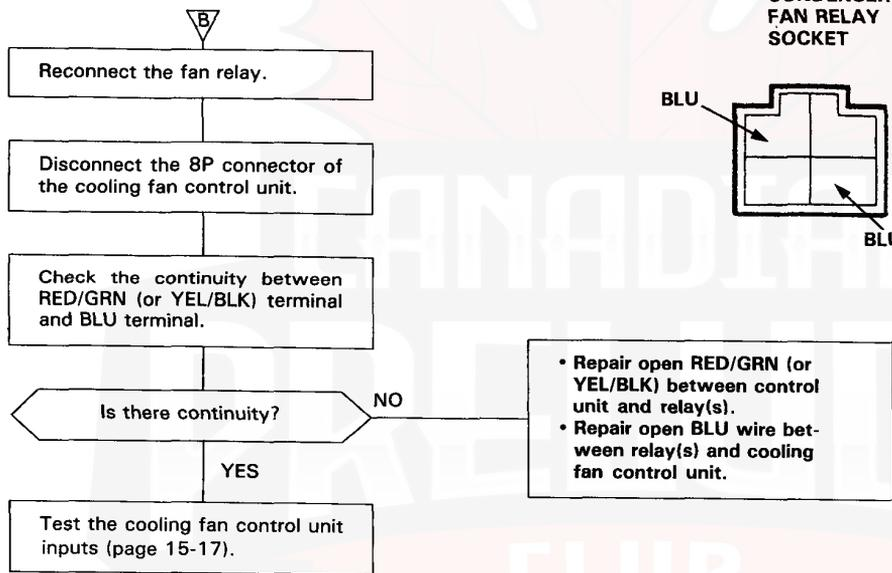

- Repair open RED/GRN (or YEL/BLK) between control unit and relay(s).
- Repair open BLU wire between relay(s) and cooling fan control unit.

Service Tips

▲ WARNING When handling refrigerant (R-12):

- Always wear eye protection.
- Do not let refrigerant get on your skin or in your eyes; if it does:
 - Do not rub your eyes or skin.
 - Splash large quantities of cool water in your eyes or on your skin.
 - Rush to a physician or hospital for immediate treatment. Do not attempt to treat it yourself.
- Keep refrigerant containers (cans of R-12) stored below 40°C (100°F).
- Do not handle or discharge refrigerant in an enclosed area near an open flame; it may ignite and produce a poisonous gas.
- The ozone is a fragile layer surrounding the earth which acts as a shield against the sun's ultra-violet radiation. Chlorine from chemicals called Chlorofluorocarbons (CFCs) destroy the ozone in the stratosphere. Automotive air conditioning systems currently use Chlorofluorocarbons as the refrigerant. Auto air conditioning service equipment has been developed to minimize the release of CFCs to the atmosphere. All service procedures should be performed using this equipment and the manufactures instructions.

CAUTION:

1. Always disconnect the negative cable from the battery whenever replacing air conditioner parts.
2. Keep moisture and dust out of the system. When disconnecting any lines, plug or cap the fittings immediately; don't remove the caps or plugs until just before the lines are reconnected.
3. Before connecting any hose or line, apply a few drops of refrigerant oil to the seat of the O-ring or flare nut.
4. When tightening or loosening a fitting, use a second wrench to support the matching fitting
5. When discharging the system, don't let refrigerant escape too fast; it will draw the compressor oil out of the system.
6. Add refrigerant oil after replacing the following parts;

Condenser 10 cc (1/3 fl oz)

Evaporator 30 cc (1 fl oz)

Line or hose 10 cc (1/3 fl oz)

Receiver 10 cc (1/3 fl oz)

Compressor On compressor replacement, subtract the volume of oil drained from the removed compressor from 130 cc (4.4 fl oz), and drain the calculated volume of oil from the new compressor:

$$130 \text{ cc (4.4 fl oz)} - \text{Volume of removed compressor} = \text{Draining volume (Matsushita)}$$

OLD COMPRESSOR

NEW COMPRESSOR

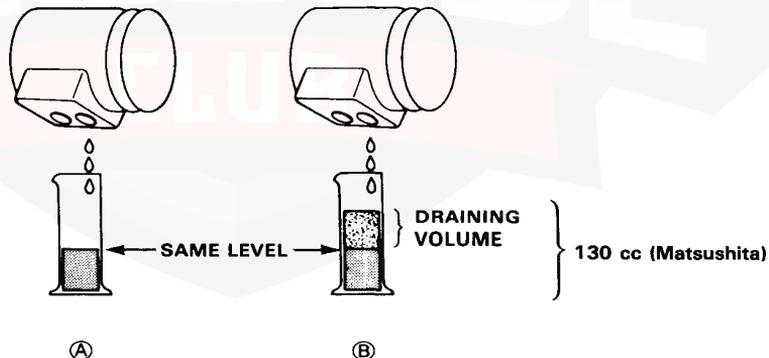



Torque specifications

- ① Suction hose evaporator side 32 N·m (3.2 kg-m, 23 lb-ft)
- ② Receiver pipe D evaporator side 17 N·m (1.7 kg-m, 12 lb-ft)
- ③ Receiver pipe D To Receiver pipe B 17 N·m (1.7 kg-m, 12 lb-ft)
- ④ Receiver pipe B To Receiver pipe A 17 N·m (1.7 kg-m, 12 lb-ft)
- ⑤ Condenser pipe To Condenser 17 N·m (1.7 kg-m, 12 lb-ft)
- ⑥ Discharge hose To Condenser 25 N·m (2.5 kg-m, 18 lb-ft)
- ⑦ Compressor hose mounting bolts 30 N·m (3.0 kg-m, 22 lb-ft)
- ⑧ Receiver tank 17 N·m (1.7 kg-m, 12 lb-ft)

Compressor (Matsushita)

- ⑨ Compressor mounting bolts (8 x 130 mm) 25 N·m (2.5 kg-m, 18 lb-ft)
- ⑩ Compressor bracket mounting bolts (10 x 40 mm) 48 N·m (4.8 kg-m, 35 lb-ft)
- ⑪ Compressor bracket mounting bolt (10 x 55 mm) 48 N·m (4.8 kg-m, 35 lb-ft)
- ⑫ Compressor bracket mounting bolt (10 x 65 mm) 48 N·m (4.8 kg-m, 35 lb-ft)
- ⑬ Compressor bracket mounting bolt (10 x 70 mm) 48 N·m (4.8 kg-m, 35 lb-ft)

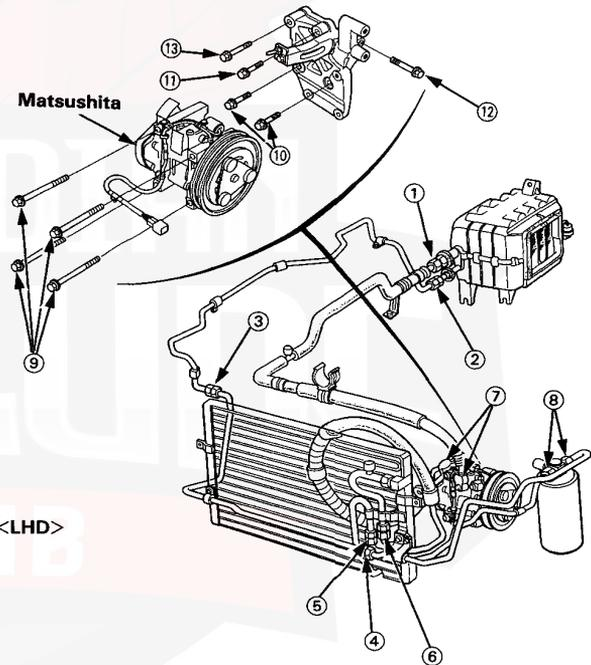

Evaporator

Replacement

1. Disconnect the battery negative terminal.
2. Discharge the refrigerant.
3. Disconnect the receiver line and suction hose from the evaporator.

CAUTION: Cap the open fittings immediately to keep moisture out of the system.

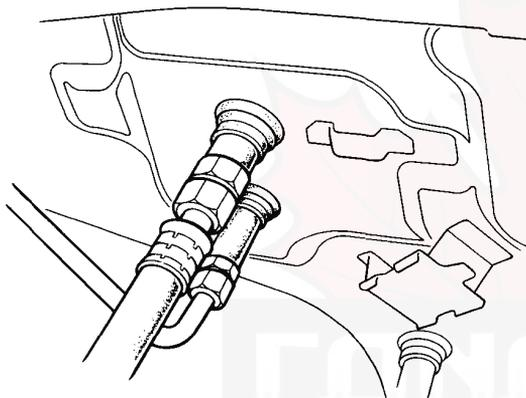

4. Remove the glove box.
5. Disconnect the connector from the A/C thermostat and pull off the wire harness from the clamps.

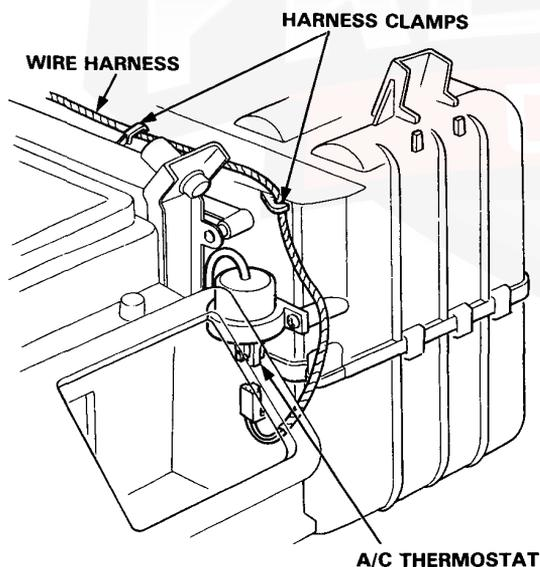

6. Remove the tapping screws (4) and blower band.

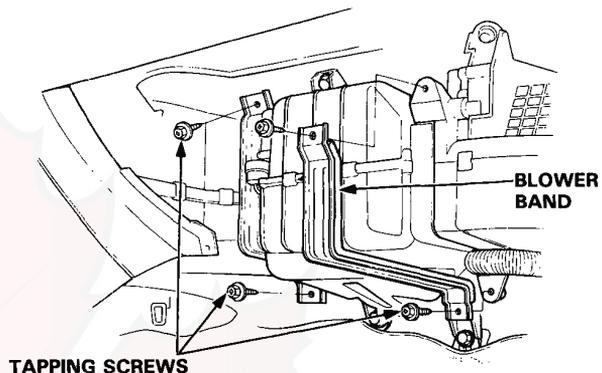

7. Remove the mounting bolts (4) and evaporator.
8. Remove the tapping screw and evaporator band if necessary.

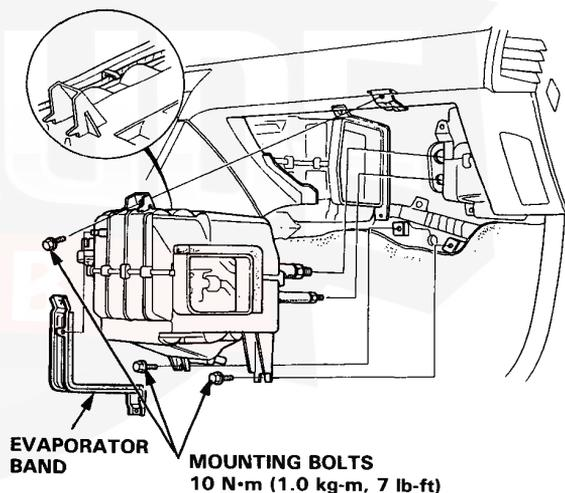

9. Install in the reverse order of removal, and:
 - Apply a sealant to the grommets.
 - Make sure that there is no air leakage.
 - Charge the system (page 15-36).

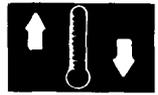

Overhaul

1. Pull out the evaporator sensor from the evaporator fins.
2. Remove the tapping screws and clips from the housing.
3. Carefully separate the housings and remove the evaporator covers.
4. Remove the expansion valve if necessary.

Assemble the evaporator in the reverse order of disassembly, and:
Install the expansion valve capillary tube against the suction line, and wrap it with tape.
Reinstall the evaporator sensor in its original location.

TAPE
Replace
Make sure there is no foreign matter stuck between the capillary tube and outlet line.

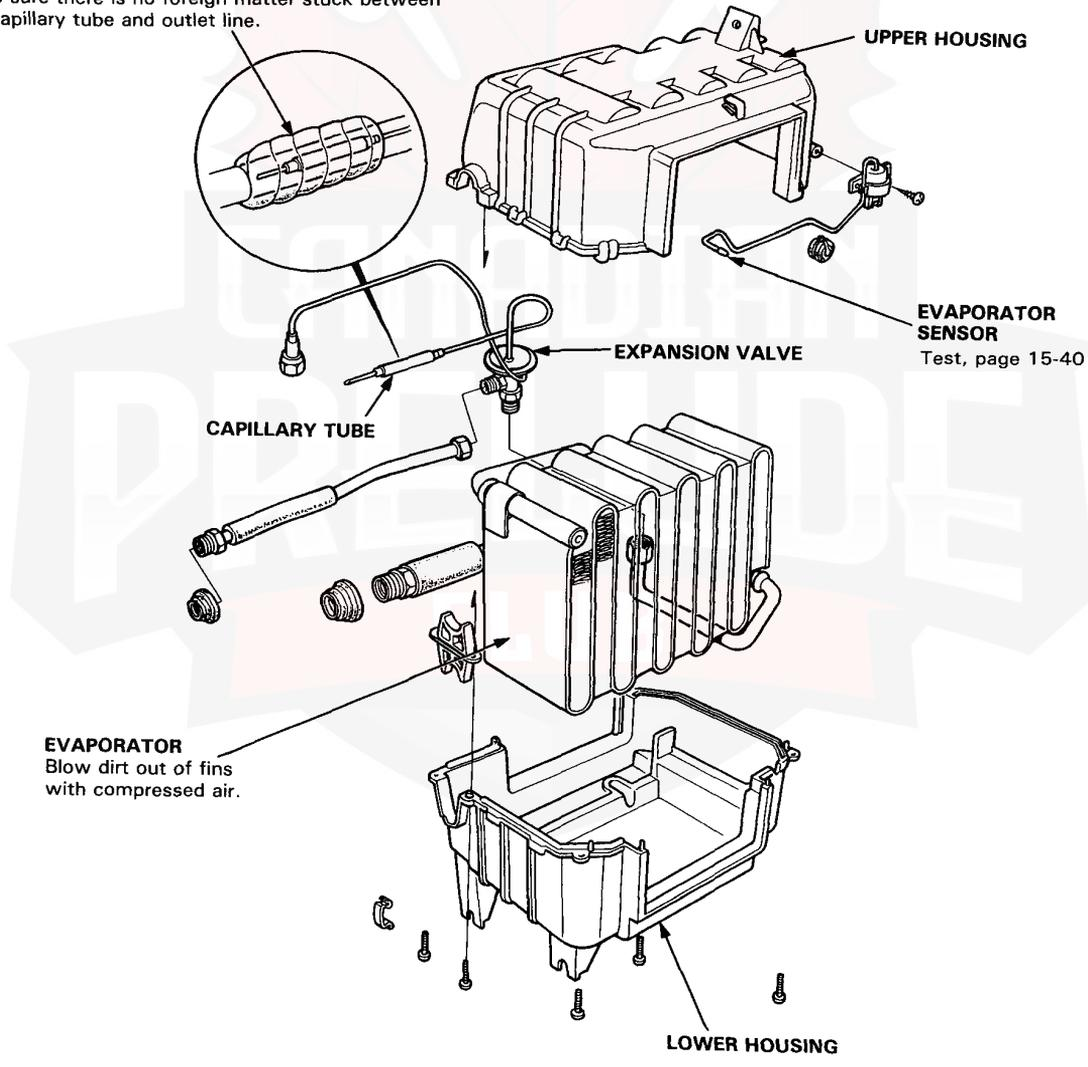

Condenser Replacement

1. Discharge the refrigerant.
2. Remove the front bumper and engine hood lock (section 20).
3. Disconnect the condenser line and discharge line from the condenser.

CAUTION: Cap the open fittings immediately to keep moisture and dirt out of system.

4. Remove the mounting bolts (2) and condenser.
5. Install in the reverse order of removal, and charge the system (page 15-36) and test performance (page 15-40).

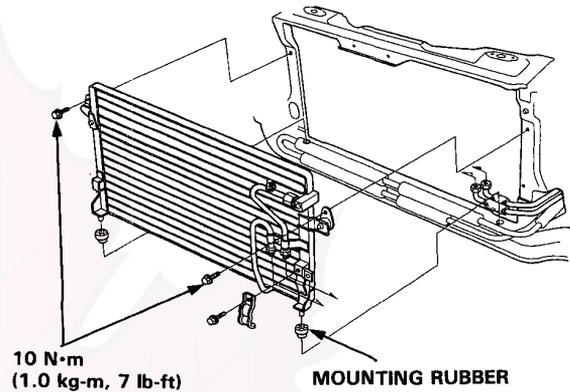



Compressor (Matsushita)

Description

This compressor is the three-vane, rotary type and consists of three vanes that come out of the rotor to the cylinder wall, reed valve that prevents backflow, and magnetic clutch. The thermal protector for compressor control and pick-up sensor are installed on this compressor.

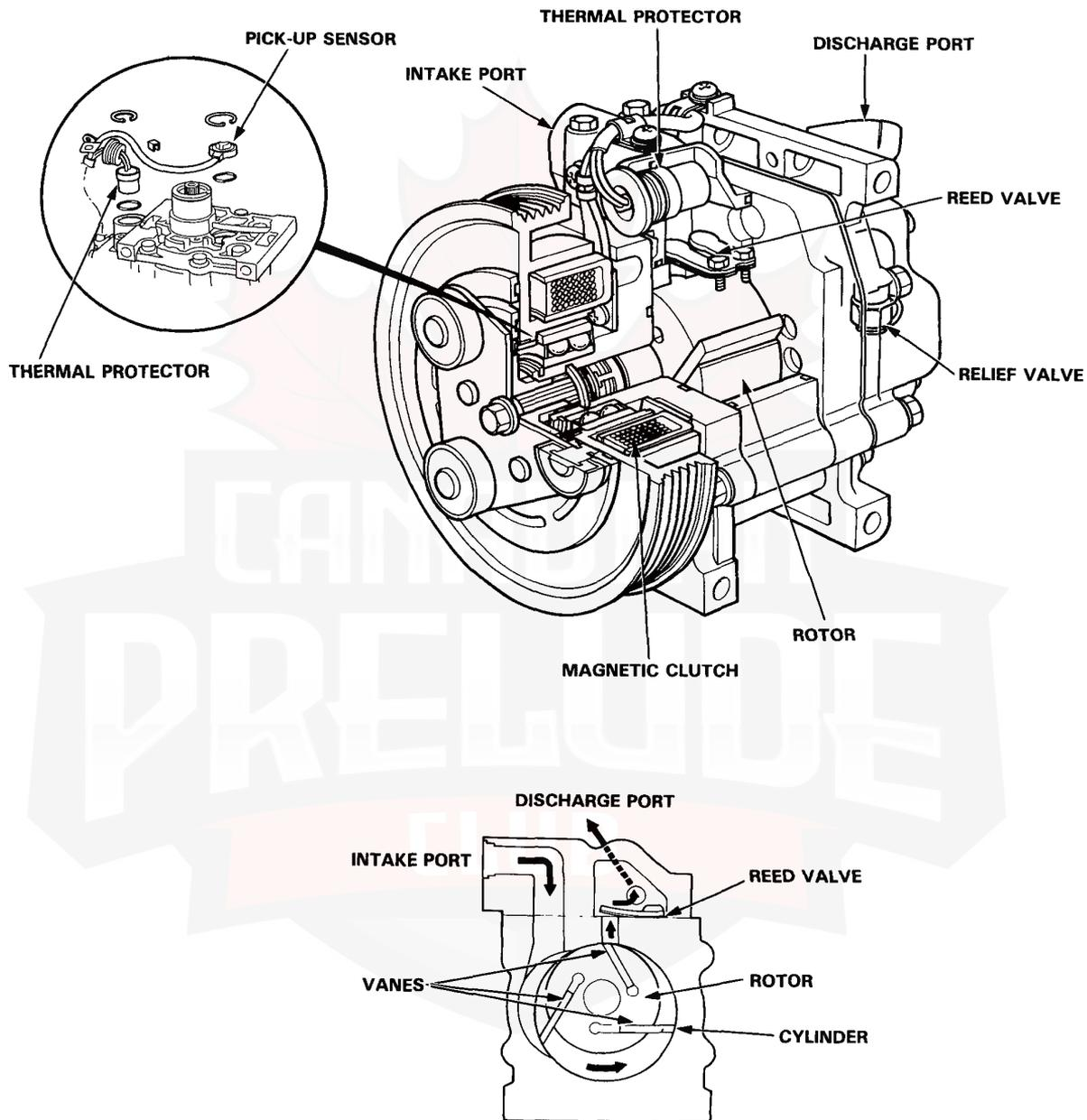

Compressor (Matsushita)

Troubleshooting

TEST RESULTS	RELATED SYMPTOMS	PROBABLE CAUSE	REMEDY
Discharge (high) pressure abnormally high	After stopping compressor, pressure drops to about 196 kPa (28 psi) quickly, and then falls gradually	Air in system	Evacuate system; then recharge
	No bubbles in sight glass when condenser is cooled by water	Excessive refrigerant in system	Discharge refrigerant as required
	Reduced or no air flow through condenser.	<ul style="list-style-type: none"> • Clogged condenser or radiator fins • Condenser or radiator fan not working properly. 	<ul style="list-style-type: none"> • Clean • Check voltage and fan rpm
	Line to condenser is excessively hot	Restricted flow of refrigerant in system	Expansion valve
Discharge pressure abnormally low	Excessive bubbles in sight glass; condenser is not hot	Insufficient refrigerant	<ul style="list-style-type: none"> • Charge system • Check for leak
	High and low pressures are balanced soon after stopping compressor	<ul style="list-style-type: none"> • Faulty compressor discharge or inlet valve • Faulty compressor seal 	Replace compressor Repair
	Outlet of expansion valve is not frosted, low pressure gauge indicates vacuum	• Faulty expansion valve	Repair or Replace
Suction (low) pressure abnormally low	Excessive bubbles in sight glass; condenser is not hot Expansion valve is not frosted and low pressure line is not cold. Low pressure gauge indicates vacuum.	Insufficient refrigerant <ul style="list-style-type: none"> • Frozen expansion valve • Faulty expansion valve 	Check for leaks. Charge as required. Replace expansion valve
	Discharge temperature is low and the air flow from vents is restricted	Frozen evaporator	Run the fan with compressor off then check the thermostat and capillary tube.
	Expansion valve frosted	Clogged expansion valve	Clean or Replace
	Receiver dryer is cool (should be warm during operation)	Clogged receiver dryer	Replace
Suction pressure abnormally high	Low pressure hose and check joint are cooler than around evaporator	<ul style="list-style-type: none"> • Expansion valve open too long • Loose expansion valve 	Repair or Replace
	Suction pressure is lowered when condenser is cooled by water	Excessive refrigerant in system	Discharge refrigerant as necessary
	High and low pressure are balanced too equalized as soon as the compressor is stopped	<ul style="list-style-type: none"> • Faulty gasket • Faulty high pressure valve • Foreign particle stuck in high pressure valve 	Replace compressor
Suction and discharge pressures abnormally high	Reduced air flow through condenser	<ul style="list-style-type: none"> • Clogged condenser or radiator fins • Condenser or radiator fan not working properly 	<ul style="list-style-type: none"> • Clean condenser and radiator • Check voltage and fan rpm
	No bubbles in sight glass when condenser is cooled by water	Excessive refrigerant in system	Discharge refrigerant as necessary.
Suction and discharge pressure abnormally low	Low pressure hose and metal end areas are cooler than evaporator	Clogged or kinked low pressure hose parts	Repair or Replace
	Temperature around expansion valve is too low compared with that around receiver-driver.	Clogged high pressure line	Repair or Replace
Refrigerant leaks	Compressor clutch is dirty	Compressor shaft seal leaking	Replace compressor shaft seal
	Compressor bolt(s) are dirty	Leaking around bolt(s)	Replace compressor
	Compressor gasket is wet with oil	Gasket leaking	Replace compressor

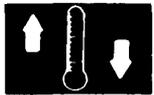

Replacement

1. If the compressor is marginally operable, run the engine at idle speed and turn on the air conditioner fan a few minutes, then shut the engine off and disconnect the battery negative terminal.
2. Discharge the refrigerant.
3. Loosen the idle pulley nut and adjusting bolt, and remove the power steering oil pump belt.

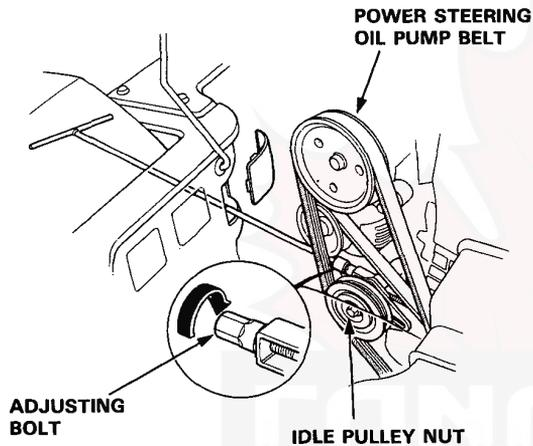

4. Disconnect the Power steering oil pump inlet hose.
5. Remove the mounting bolts (2) and power steering oil pump.

NOTE: Cover the alternator with shop towels.

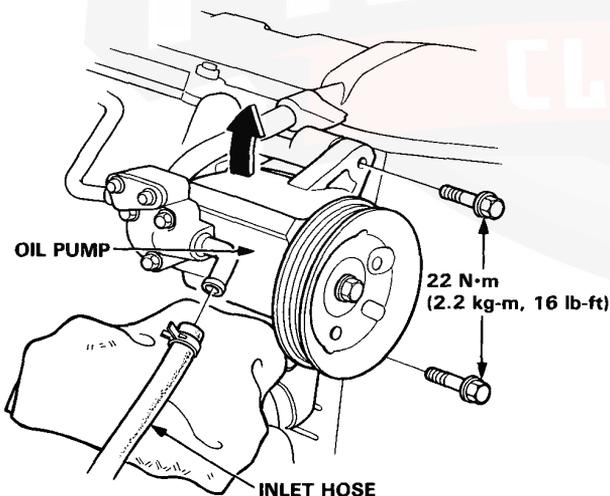

6. Disconnect the alternator wire harness connectors from the alternator.
7. Loosen the adjusting nut and remove the compressor belt.

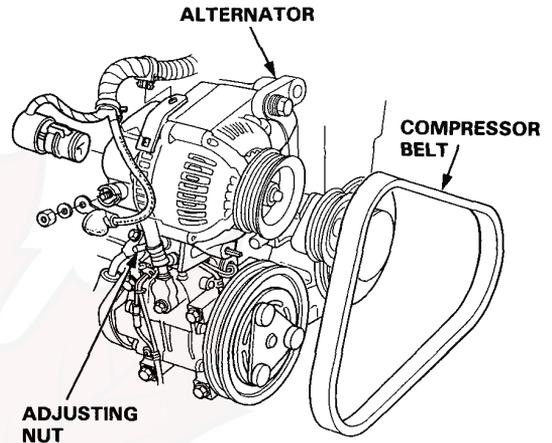

8. Remove the mounting bolts and alternator.

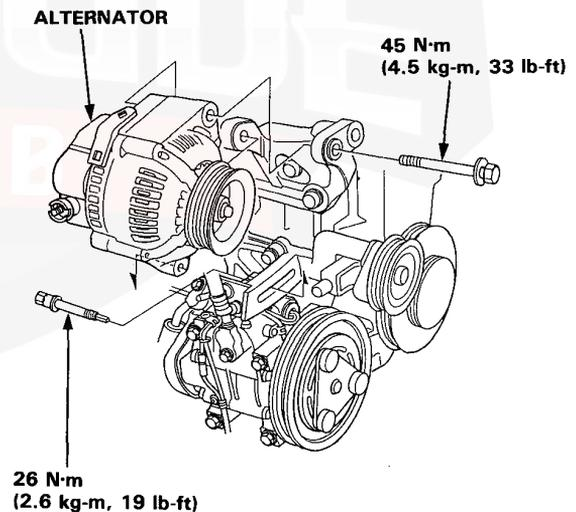

(cont'd)

Compressor (Matsushita)

Replacement (cont'd)

9. Disconnect the compressor connector.
10. Disconnect the suction and discharge hoses from the compressor.

CAUTION: Cap the open fittings immediately to keep moisture and dirt out of the system.

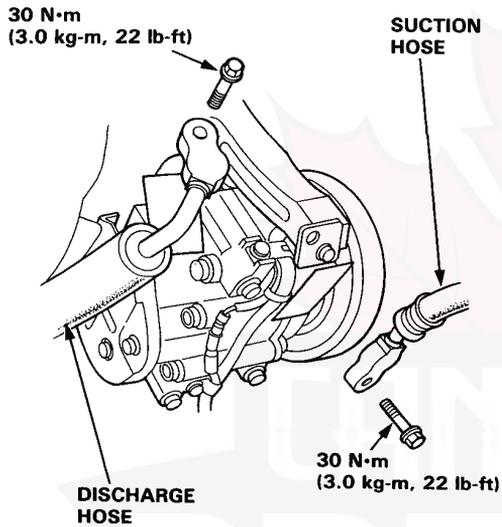

11. Remove the compressor mounting bolts (4) and compressor. Rest the compressor on the front beam.

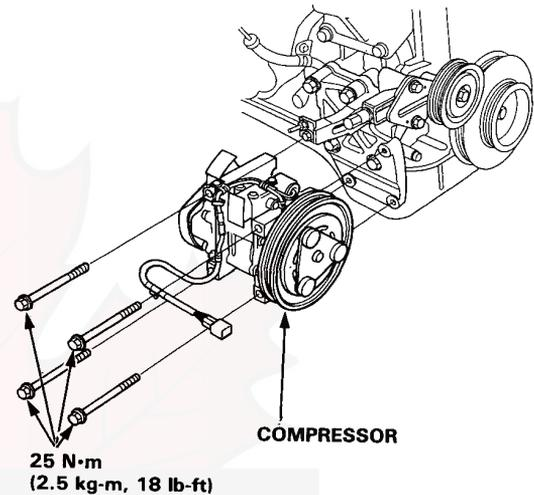

12. Remove the mounting bolts (2) and idle pulley.

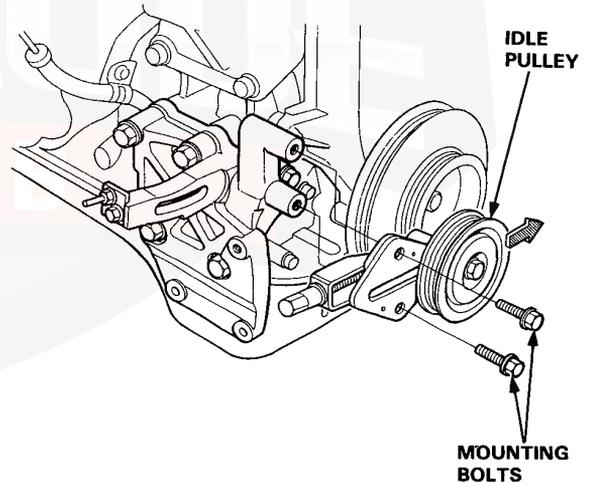



13. Remove the mounting bolts (5) and compressor bracket.

14. Remove the dowel pins.

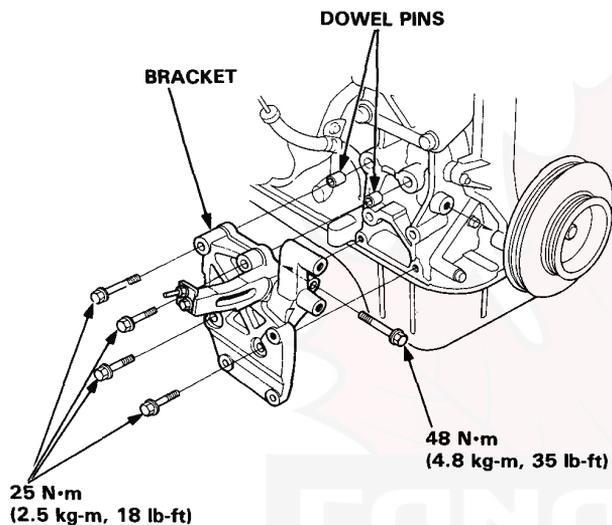

15. Install in the reverse order of removal and:

- If a new compressor is installed, calculate the refrigerant oil as below and drain through the suction fitting on the compressor.

Draining volumes =
130 cc (4.4 fl oz) – subtract volume of removed compressor

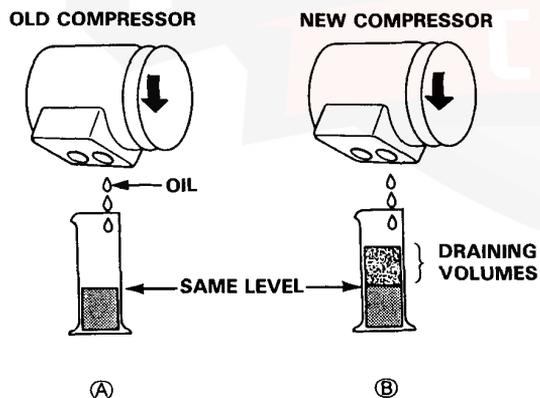

- Charge the system (page 15-36).
- Test the performance.

Belt Adjustment

NOTE: Measure the deflection when 98 N (10 kg, 22 lb) force is applied between the pulleys.

- Ⓐ : 11–13 mm (0.43–0.52 in)
[9–11 mm (0.35–0.43 in) when new belt is installed]
- Ⓑ : 10–12 mm (0.39–0.49 in)
[6–8 mm (0.24–0.32 in) when new belt is installed]

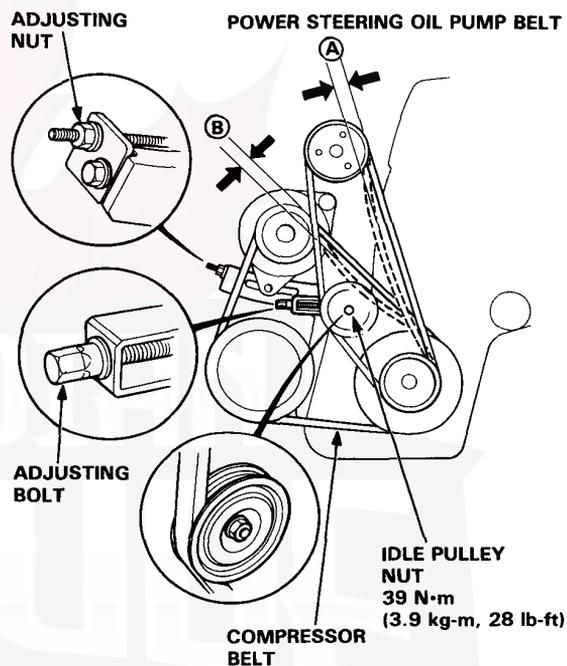

Compressor (Matsushita)

Clutch Inspection

- Check pulley bearing play and drag by rotating the pulley by hand. Replace the pulley with a new one if it is noisy or has excessive play and drag.

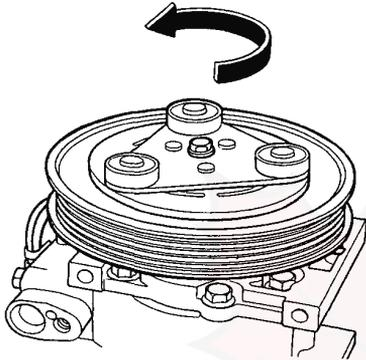

- Check resistance of the field coil:

Field Coil Resistance:

3.38 ± 0.17 ohm at 20°C (68°F)

If resistance is not within specifications, replace the coil.

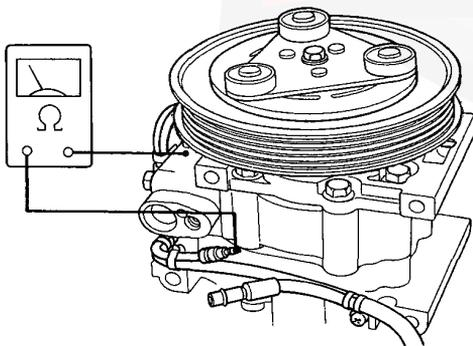

- Measure the clearance between the pulley and pressure plate. If the clearance is not within specified limits, the pressure plate must be removed and shims added or removed as required.

CLEARANCE: 0.4–0.6 mm (0.016–0.024 in)

CREARANCE = A(CLUTCH OFF) – B(CLUTCH ON)

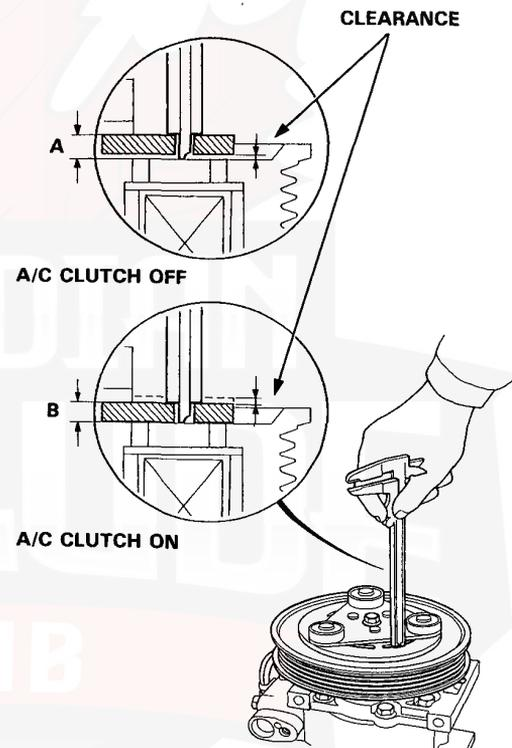

NOTE:

The shims are available in two sizes: 0.2 mm and 0.5 mm of thickness.

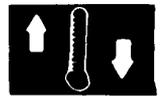

Thermal Protector Inspection

Check for continuity between the 2 and 4 terminals of the compressor connector.

There should be continuity.

- If no continuity, replace the thermal protector.

NOTE: Replace the thermal protector and pick-up as a set.

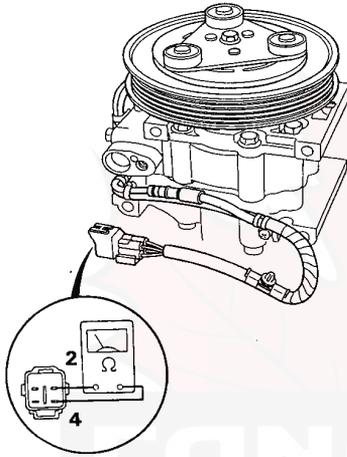

Thermal Protector/Pick-up Sensor Replacement

1. Remove the pressure plate and stator (page 15-32).
2. Pull the rubber cap out from the thermal protector.
3. Remove the circlips and thermal protector and pick-up sensor.

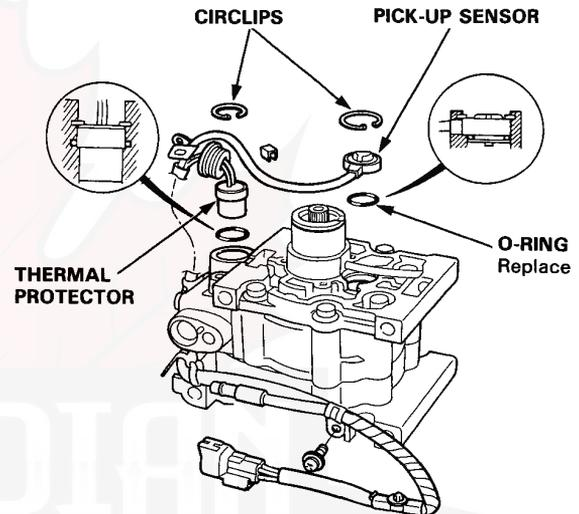

Pick-up Sensor Inspection

Measure resistance between the 1 and 3 terminals of the compressor connector.

There should be between 450–600 ohms.

- If no continuity replace the pick-up sensor.

NOTE: Replace the pick-up sensor and thermal protector as a set.

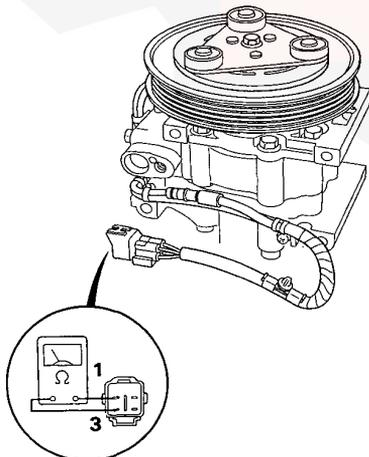

4. Install in the reverse order of removal.

NOTE:

- Replace the O-rings with new ones.
- Set the new O-rings in place as shown.

Compressor (Matsushita)

Clutch Overhaul

1. Remove the center bolt.

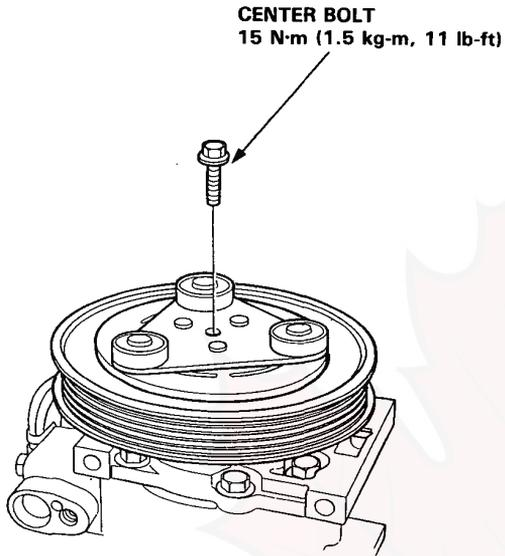

2. Remove the pressure plate and shim(s) taking care not to lose the shims.

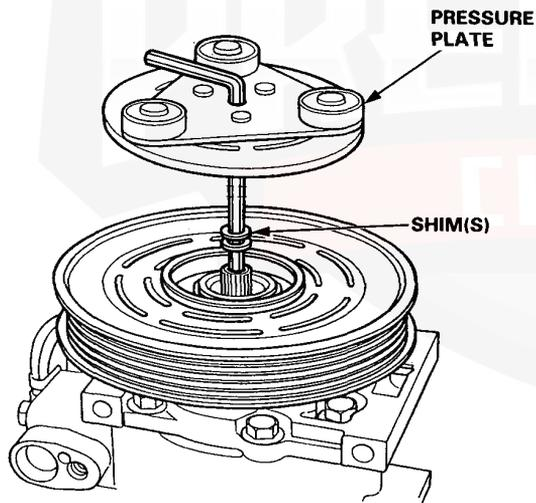

3. Use circlip pliers to remove the circlip.

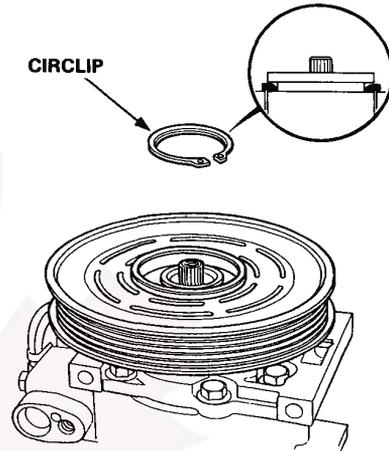

4. Remove the pulley from the shaft using a 2 or 3 jaw puller.
5. Check the pulley, replace the compressor assembly if the pulley is damaged or deformed.

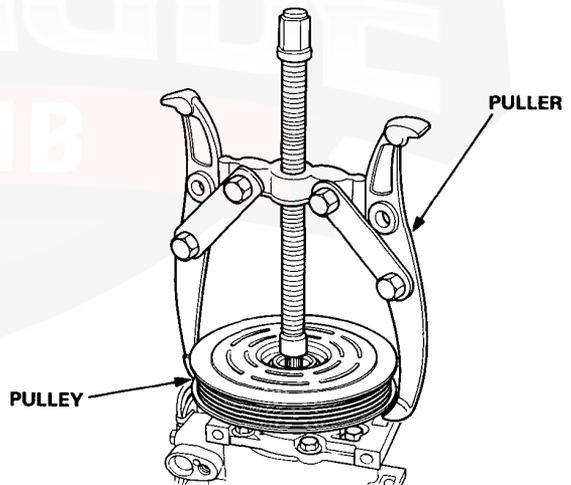



6. Remove screws (3) and disconnect the stator coil connector and remove the screws (3) and stator.

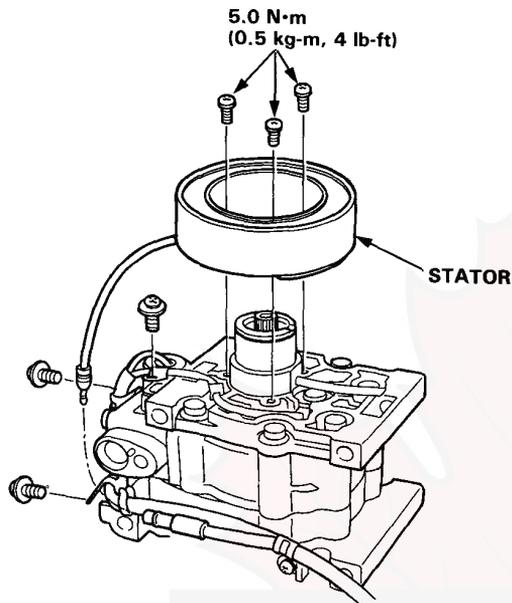

7. Install in the reverse order of removal and:

- Install the stator with the wire side facing up (see above).
- Clean the pulley and compressor sliding surfaces with non-petroleum solvent.
- Check the pulley bearings for excessive play.

- Make sure the circlip is fitted to the groove properly.

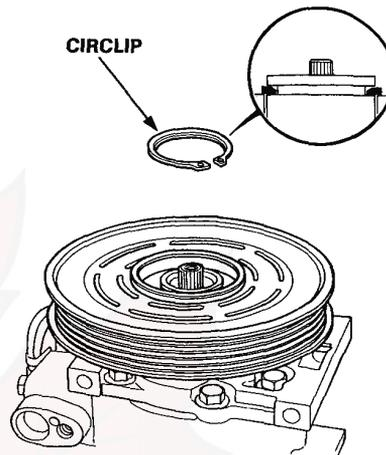

- Apply locking agent to the thread of the center bolt and tighten it securely.
- Make sure that the pulley turns smoothly.

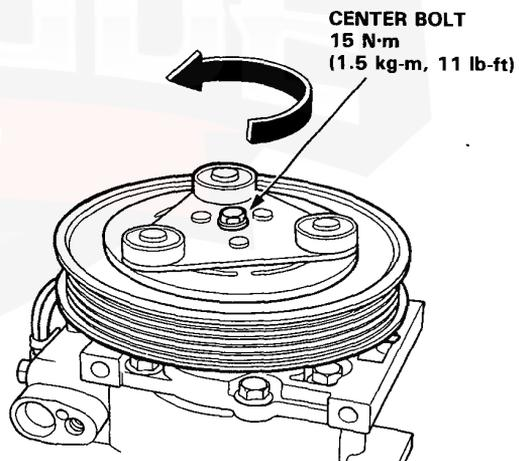

Compressor (Matsushita)

Shaft Seal Replacement

NOTE: Make sure that the suction and discharge joints are plugged with the caps.

1. Remove the pressure plate (page 15-32).

NOTE: Removal of the clutch pulley and coil is not necessary.

2. Remove the dust seal and circlip.

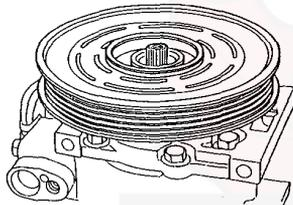
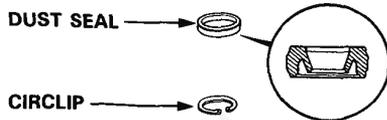

3. Remove the shim(s).

NOTE: After removing, place shim(s) safely in a parts rack.

4. Insert the special tool into the compressor aligning the cutout of the remover with the groove of the seal seat.
5. Rotate the special tool counterclockwise to make sure that the cutout is engaged with the seal seat.
6. Pull out the seal seat.

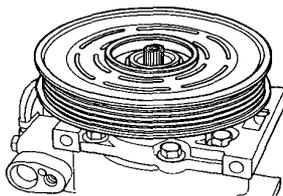
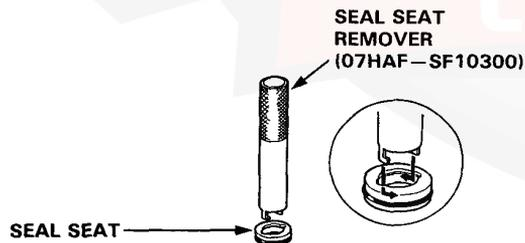

7. Insert the special tool into the compressor aligning the cutout of the remover with the metal pawl of the seal case.
8. Rotate the special tool counter clock wise to make sure that the cutout is engage with the metal pawl.

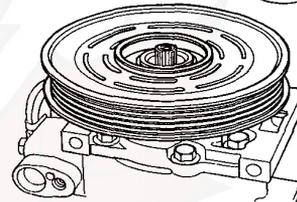
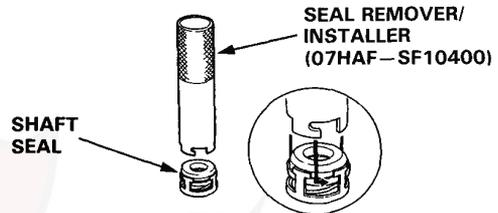

9. Withdraw the remover.
10. Lay down the compressor and clean the shaft seal contacting face of the compressor with cleaning solvent.

CAUTION:

- Keep the cleaning solvent and dirt out of the compressor.
- Do not use any cloth for cleaning, clean only by rinsing with solvent.
- Do not spill the refrigerant oil from the compressor. Refill the same amount of the oil if the oil is spilled out.

11. Clean the new shaft seal thoroughly with cleaning solvent.
12. Lubricate the shaft seal with refrigerant oil (SUNISO 5GS or equivalent) and install it on the shaft seal remover.

NOTE:

- Use only clean refrigerant oil.
- Do not touch the sealing surfaces of the shaft seal after lubricating.

13. Liberally lubricate the compressor shaft with refrigerant oil.
14. Install the shaft seal onto the compressor shaft aligning the seal case flats with the shaft flats.

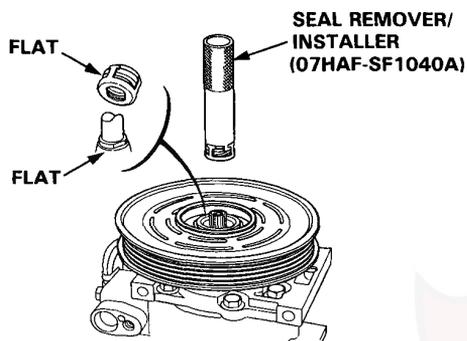

15. Clean the seal seat with cleaning solvent, then lubricate the seal seat with refrigerant oil (SUNISO 5GS or equivalent).

NOTE:

- Use only clean refrigerant oil.
- Do not touch the sealing surface of the seal plate after lubricated.

16. First slide the seal seat into the compressor by hand as far as possible.
17. Press the seal seat with the grip side of the remover.
18. Install the circlip with its chamfered edge inside.
19. Press the circlip with the grip side of the remover, then install the dust seal.

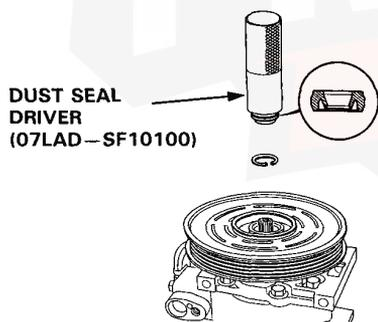

20. Install the shim(s).
21. Install the pressure plate. Measure the clearance between the pulley and pressure plate all the way around. If the clearance is not within the specified limits, [0.3–0.45 mm (0.012–0.018 in)] shims must be added or removed as required.

System Charging

System Evacuation

The following are the procedures to be adhered to when servicing air conditioners to reduce the amount of Freon R-12 into the atmosphere.

1. When an A/C System has been opened to the atmosphere, such as during installation or repair, it must be evacuated using a vacuum pump. (If the system has been open for several days, the receiver/dryer should be replaced).

2. Connect a gauge, pump and refrigerant containers (cans of R-12) as shown.

NOTE: Do not open the cans.

3. Start the pump, then open the both pressure valves, both pressure stop valves and evacuation valve (2 valve gauge: evacuation stop valve). Run the pump about 15 minutes. Close the both pressure valves

and evacuation valve (2 valve gauge: evacuation stop valve) and stop the pump. The low gauge should indicate above 700 mmHg (27 in-Hg) and remain steady with the valves closed.

NOTE: If low pressure does not reach more than 700 mmHg (27 in-Hg) in 15 minutes, there is probably a leak in the system. Check for leaks, and repair (see Leak Test).

4. If there are no leaks open the valves and continue pumping for at least another 15 minutes, then close both valves, stop the pump.

3 VALVE GAUGE

2 VALVE GAUGE

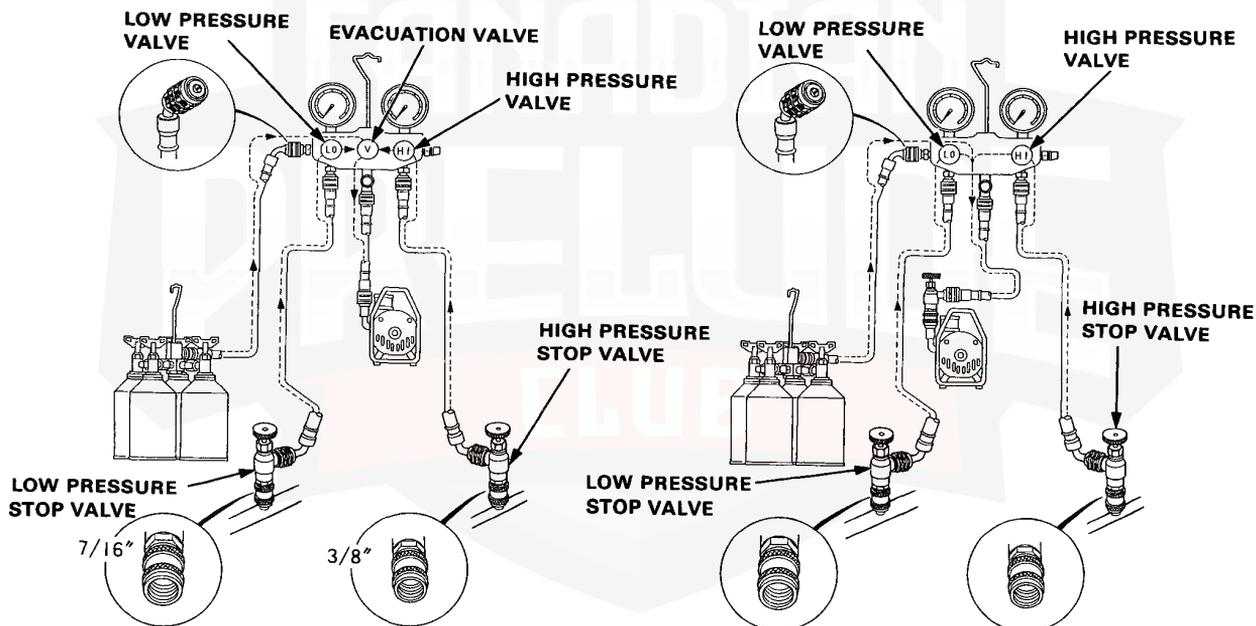

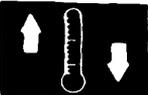

Leak Test

The following are the procedures to be adhered to when servicing air conditioners to reduce the amount of from R-12 into the atmosphere.

WARNING

When handling refrigerant (R-12):

- Always wear eye protection.
- Do not let refrigerant get on your skin or in your eyes. If it does:
 - Do not rub your eyes or skin.
 - Splash large quantities of cool water in your eyes or on your skin.
 - Rush to a physician or hospital for immediate ment. Do not attempt to treat it yourself.
- Keep refrigerant containers (cans of R-12) stored below 40°C (100°F).
- Keep away from open flame. Refrigerant, although non-flammable, will produce poisonous gas if burned.
- Work in well-ventilated area. Refrigerant evaporates quickly, and can force all the air out of a small, enclosed area.

NOTE: Check for leaks after evacuation.

1. Close the evacuation valve (2 valve gauge; evacuation stop valve).

2. Open the cans.
3. Open high pressure valve to charge the system to about 100 kpa (14 psi), then close the supply valve. NOTE: Particularly check for leaks around the compressor, condenser, and receiver-driver.
5. If you find any leaks, tighten the joint nuts and to the specified torque.
6. Recheck the system for leaks using a leak detector.
7. If you find leaks that require the system to be opened (to repair or replace hoses, fittings, etc.), release any charge in the system.
8. After checking and repairing leaks, the system must be evacuated (see System Evacuation on page 15-12).

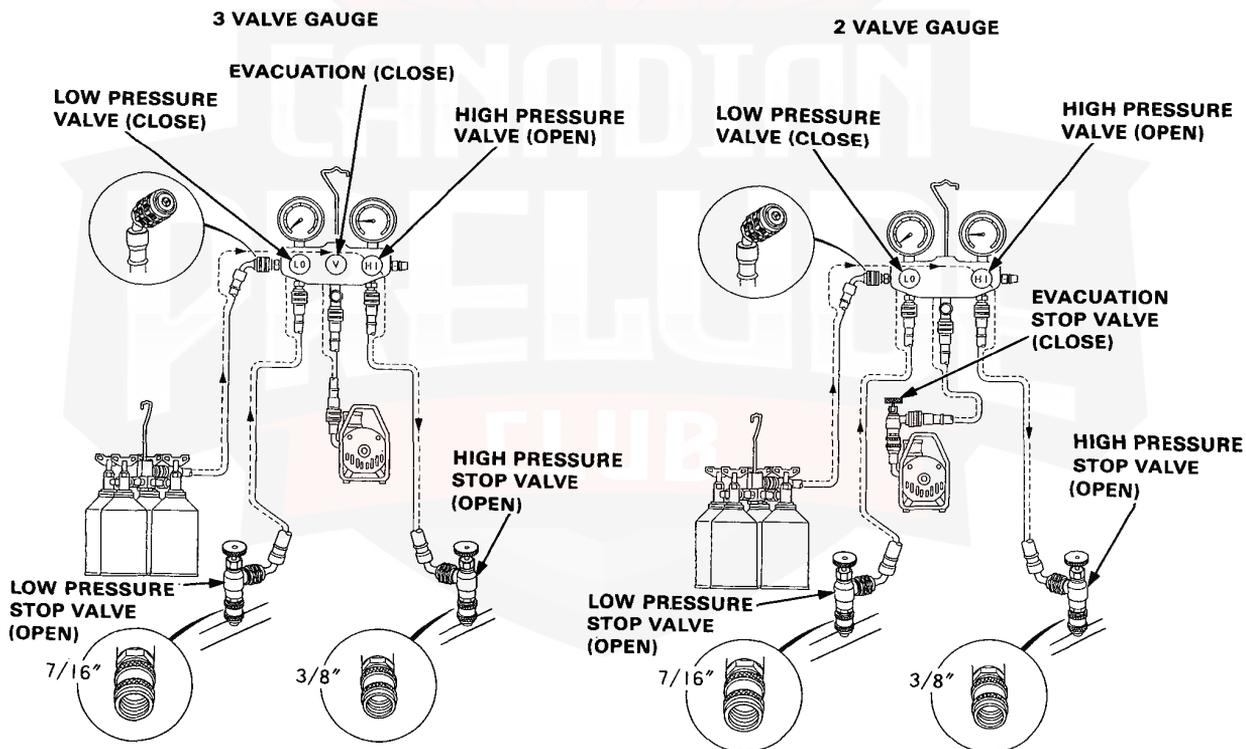

System Charging

Charging Procedures

The following are the procedures to be adhered to when servicing air conditioners to reduce the amount of from R-12 into the atmosphere.

▲WARNING When handling refrigerant (R-12):

- Always wear eye protection.
- Donot let refrigerant get on your skin or in your eyes. If it does:
 - Do not rub your eyes or skin.
 - Splash large quantities of cool water in your eyes or on your skin.
 - Rush to a physician or hospital for immediate ment. Do not attempt to treat it yourself.
- Keep refrigerant containers (cans of R-12) stored below 40°C (100°F).
- Keep away from open flame. Refrigerant, although non-flammable, will produce poisonous gas if burned.
- Work in well-ventilated area. Refrigerant evaporates quickly, and can force all the air out of a small, enclosed area.

CAUTION: Do not overcharge the system; the compressor will be damaged.

1. After leak test, check that the high pressure valve is closed and start the engine.

NOTE: Run the engine below 1500 rpm.

2. Open the front door. Turn the A/C switch on. Turn the air mix dial (lever) to COOL. Turn the function control switch (lever) on. Turn the heater fan switch on "E" (MAX).
3. Open the low pressure valve and charge with ant.

▲WARNING

- Do not open the high gauge valve.
 - Do not turn the cans upside down.
4. Charge the system with refrigerant capacity. Refrigerant capacity:
 - <LHD> 900⁺⁵⁰ (g)/1.98^{+0.11} (lbs)
 - <RHD> 800⁺⁵⁰ (g)/1.76^{+0.11} (lbs)
 5. When fully charged, close the low pressure valve and the refrigerant cans. Check the system.
 6. Close the high pressure stop valve.
 7. Open the low pressure valve and gradually open the high pressure valve. When both pressure gauge are the same, close the low pressure stop valve and stop the engine.
 8. Disconnect the charge hose quickly.
 9. Check the system for leaks using a leak detector. NOTE: Particularly check for leaks around the compressor, condenser, and receiver-dryer.

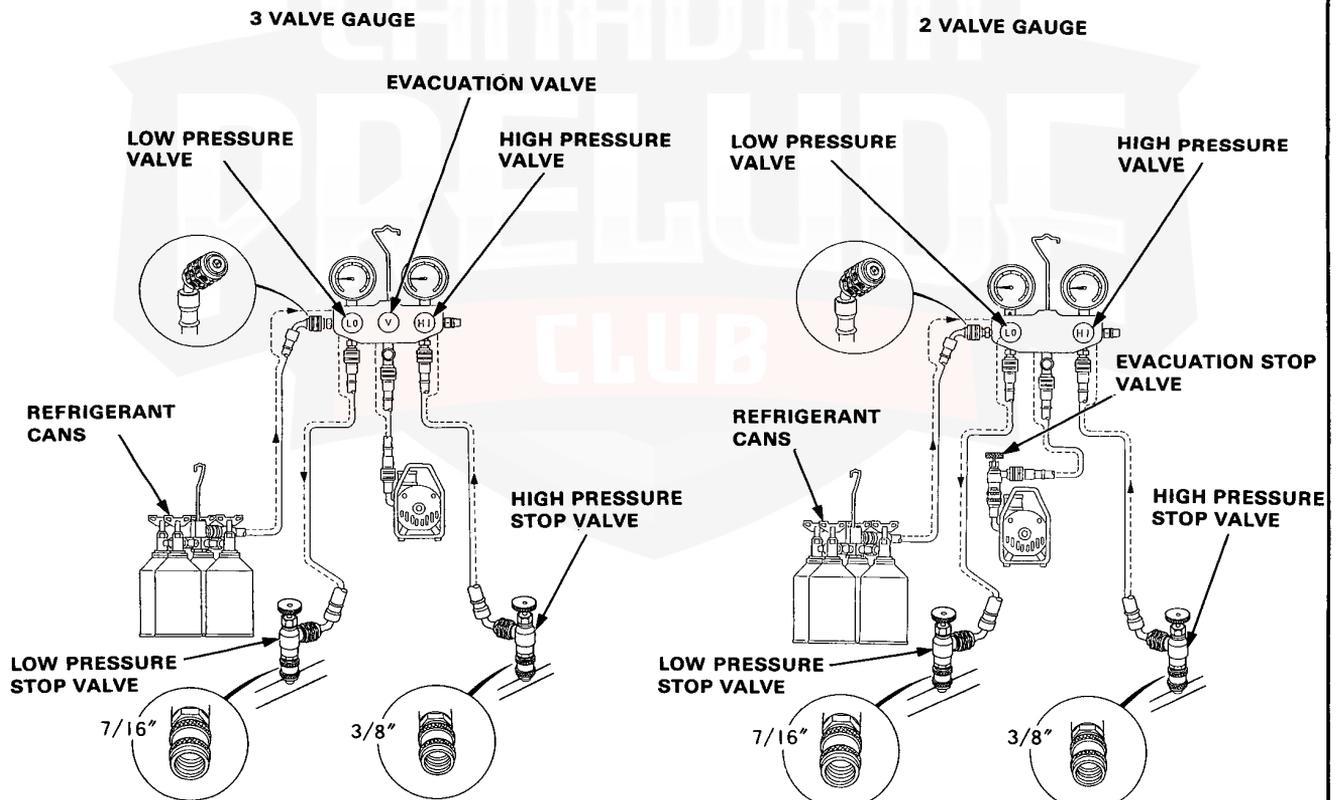

System Charging

Supplement

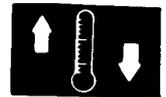

The following are the procedures to be adhered to when servicing air conditioners to reduce the amount of from R-12 into the atmosphere.

▲ WARNING When handling refrigerant (R-12):

- Always wear eye protection.
- Donot let refrigerant get on your skin or in your eyes. If it does:
 - Do not rub your eyes or skin.
 - Splash large quantities of cool water in your eyes or on your skin.
 - Rush to a physician or hospital for immediate ment. Do not attempt to treat it yourself.
- Keep refrigerant containers (cans of R-12) stored below 40°C (100°F).
- Keep away from open flame. Refrigerant, although non-flammable, will produce poisonous gas if burned.
- Work in well-ventilated area. Refrigerant evaporates quickly, and can force all the air out of a small, enclosed area.

CAUTION: Do not overcharge the system; the compressor will be damaged.

1. Connect the gauge as shown, close both pressure stop valves. Purge air from the charge hose A, then loosen the stop valve connector.
2. Attach apump and refrigerant containers (can:250 g x 2) as shown.
NOTE: Do not open cans.
3. Open both pressure valves and evacuation valve (2 valve gauge: evacuation stop valve), start the pump. The low gauge should indicate above 700 mmHg (27 in-Hg), then run the pump about 1 minute.

4. Close both pressure valves and evacuation valve (2 valve gauge: evacuation stop valve). Open both pressure stop valve.
5. Start the engine and turn on A/C switch.
6. Stop the engine and check for leaks using a leak detector.

NOTE: Particularly check for leaks around the compressor, condenser, and receiver-dryer.

7. Test the system using the pressure test and inspection data.

Test condition:

- Start the engine.
- Turn the air mix dial (lever) to COOL.
- Turn the function control switch (lever) on
- Turn the recirculation control switch on
- Turn the heater fan switch on "E" (MAX).

If there is insufficient refrigerant in system, continue to charge system.

8. Open one or two cans, open the low pressure gauge. Charge the system untill there are no bubbles in the sight glass.

▲ WARNING

- Do not open the high gauge valve.
 - Do not turn the cans upside down.
9. After adding supplemental refrigerant, close the pressure stop valve. Open the low pressure valve and gradually open the high pressure valve. When pressure gauge read same, close the low pressure stop valve and stop the engine.
 10. Disconnect the charge hose quickly.
 11. Check the system for leaks using a leak detector.

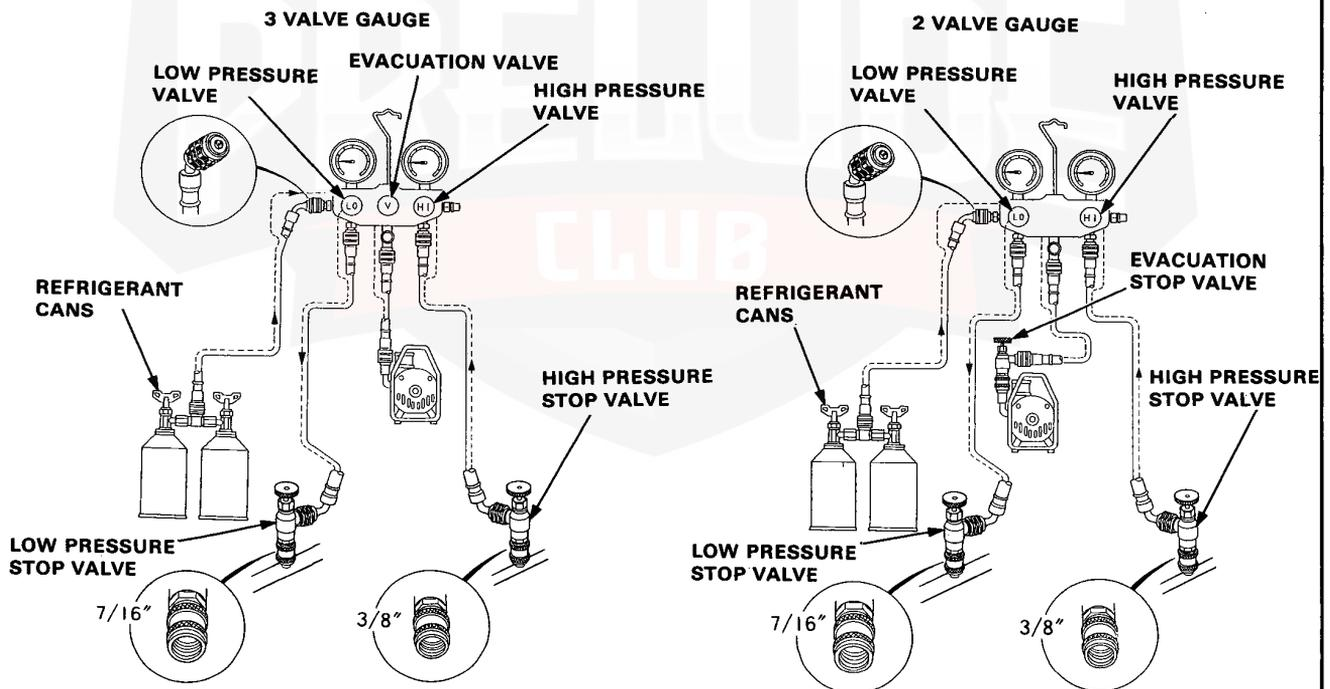

Performance Test

NOTE: The graph (Inspection data) below shows humidity between 30% and 90%, in increments of 10%.

Tolerance is $\pm 10\%$ when taking a reading.

1. Connect gauges as shown.
2. Insert a dry bulb thermometer in the cold air outlet, and place the psychrometer (dry and wet bulb thermometer) close to the inlet of blower. Do not spill wet bulb water.
3. Test conditions:
 - Avoid direct sunlight.
 - Open engine hood.
 - Open front doors and windows.
 - Set the temperature control dial to MAX COLD and push the VENT and FRESH buttons.
 - Turn the fan switch to 4.
 - Run the engine at $1,500 \text{ min}^{-1}$ (rpm).
 - No driver and passengers in car.
4. After running the system for about 10 minutes under the above conditions, read the thermometer and pressure valve.
5. The performance of the system is satisfactory if the measurements are within the range bands shown on the Performance Chart.

Proper intake/delivery pressure and temperature ranges are shown on the chart to the right.

Examples

Measurements:
Intake temperature
 (Dry bulb): 28°C (84°F)
 Humidity: 60%
Delivery temperature: 12°C (53.6°F)
Delivery pressure: 1250 kPa (12.5 kg/cm^2 , 178 psi)
Intake pressure: 180 kPa (1.8 kg/cm^2 , 25.6 psi)

Find your intake temperature across the bottom, and the relative intake and delivery pressures, and delivery temperature on the side. Draw a line through the chart at right angles to each of your measurement the vertical line should intersect each horizontal line within the range bands on the graph.

NOTE: After the test is complete, when the high pressure gauge hose is disconnected, remove the attachment from the high pressure test valve.

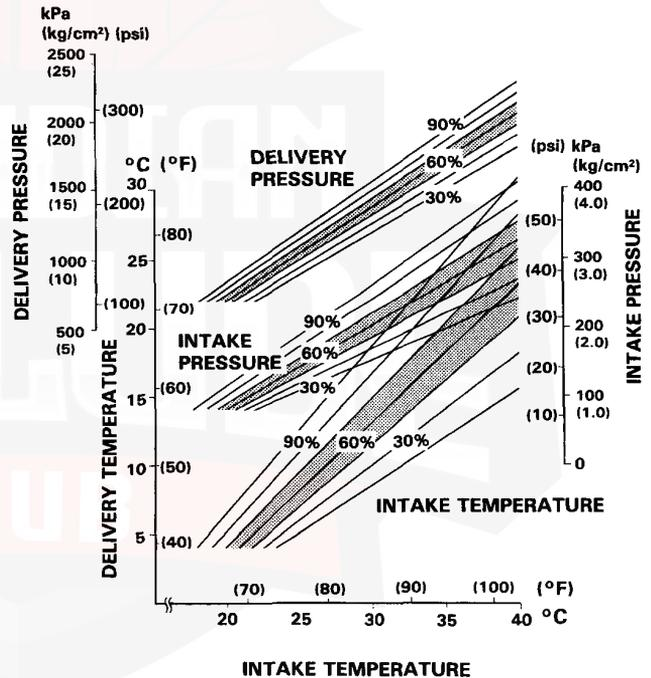
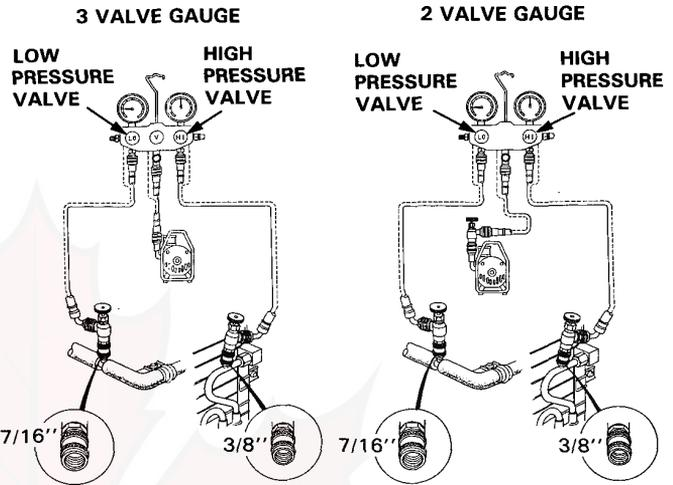



Test

Evaporator Sensor

Dip the evaporator sensor into a pan filled with ice water, and check for continuity between the terminals.

Cut off 1.5--0.5°C (35--33°F)
Cut in 2.5--5°C (36--41°F)

If cut off or cut in temperature is too low or too high, replace the thermo switch.

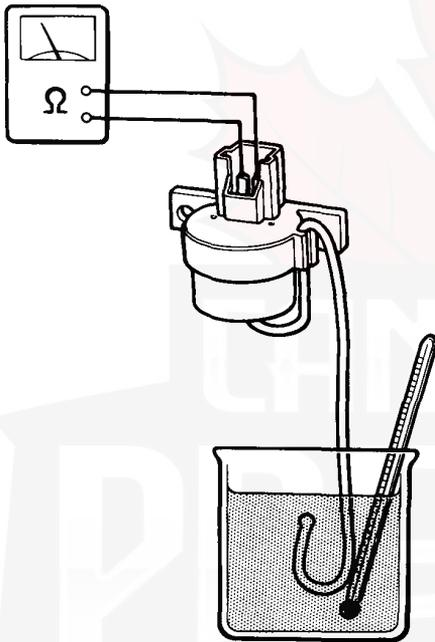

Relay

NOTE: All A/C system relays are similar.

1. Check for continuity between terminals ② and ④.
2. Connect a 12 V battery across terminals ② and ④. There should be continuity between terminals ① and ③.

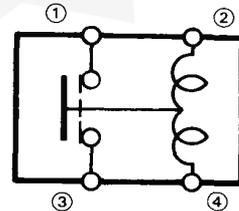
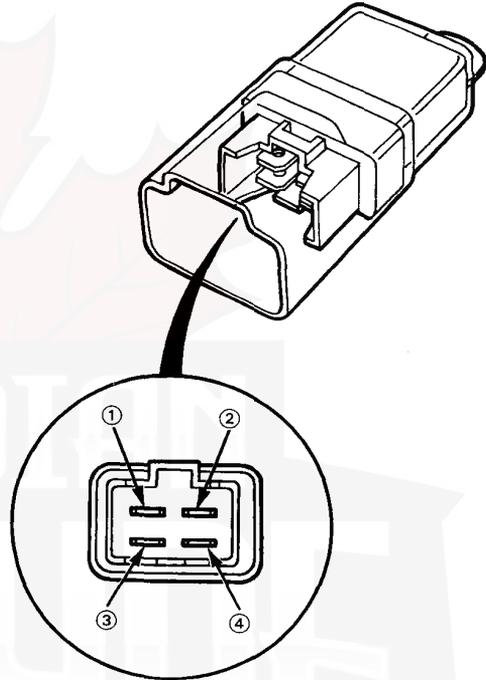

A/C Switch

Check for continuity between the terminals according to the table.

Terminal Position	④	③	②	⑤	⑥	①
OFF				○—○		
ON	○—○			○—○		
	○—○	←	○			
	○—○	←	○		←	○

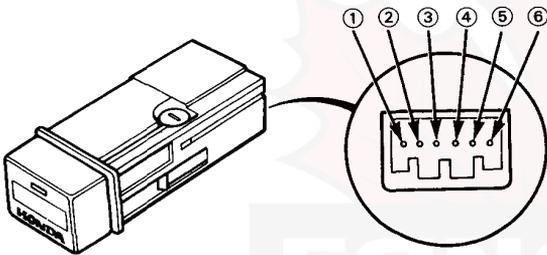

Blower Fan Switch

1. Disconnect the 6P connector from the fan switch.
2. Check for continuity between the terminals of the fan switch according to the table below.

Terminal Position	1	2	4	5	6	3
OFF						
1	○—○—○					
2	○—○			○		
3	○—○					○
4	○—○					○

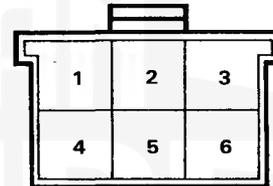

Electrical

Gauge Assembly			
Component Location Index	16-2		
Description (Cableless Speedometer)	16-3		
Gauge/Terminal Location Index	16-4		
Bulb Location	16-5		
Circuit Diagram	16-6		
Disassembly	16-8		
Removal	16-9		
Speed/Odo/Trip Meter Troubleshooting	16-10		
Speed Sensor Input Test	16-11		
Replacement	16-12		
Headlight Adjuster (KG model)			
Component Location Index	16-13		
Circuit Diagram	16-14		
Input Test	16-15		
Switch Removal	16-16		
Switch Test	16-16		
		Fog Light	
		Circuit Diagram	16-17
		Replacement	16-18
		Adjustment	16-19
		High Mount Brake Light (Rear Spoiler)	
		Circuit Diagram	16-20
		Test	16-20
		Replacement	16-21
		Cigarette Lighter	
		Component Location Index	16-22
		Circuit Diagram	16-23
		Replacement	16-24
		Relay Test	16-24
		Power Antenna Motor (with Mast Antenna Retractor Relay)	
		Circuit Diagram	16-25
		Motor Test	16-26
		Relay Test	16-27

Outline of Model Changes

- The Cableless Speedometer has been adopted.
- The Headlight Adjuster has been adopted to KG model only.
- The Fog Light has been changed.
- The Rear Spoiler High Mount Brake Light has been adopted.
- The Cigarette Lighter Relay has been added.
- The Mast Antenna Retractor Relay has been adopted due to the Rear Spoiler addition.



Gauge Assembly

Component Location Index

SPEED SENSOR

(Located on the transmission case)

Input Test, page 16-11

Replacement, page 16-12

Troubleshooting, page 16-10

GAUGE ASSEMBLY

Gauge Location Index, page 16-4

Bulb Location, page 16-5

Disassembly, page 16-8

Removal, page 16-9

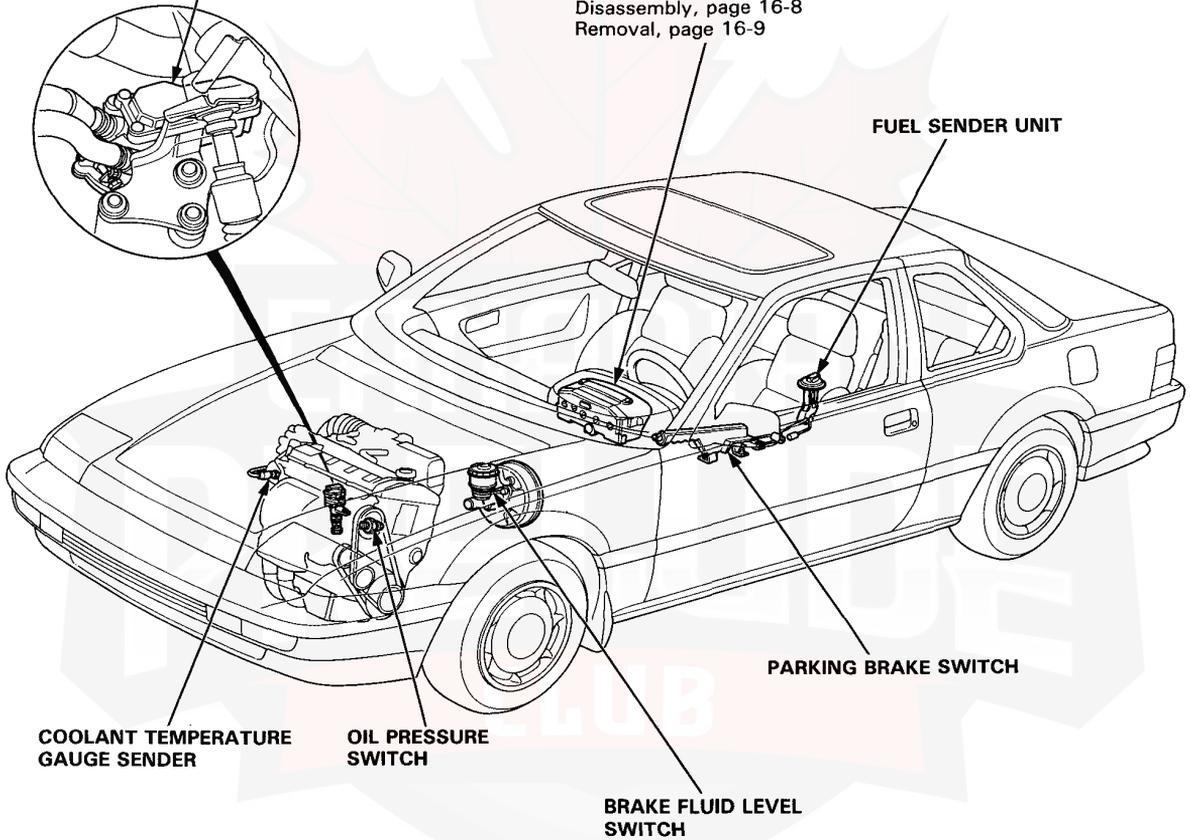



Description

Cableless Speedometer:

This consists of an electrical speed sensor on the transmission case, a speedometer control circuit and a bobbin (cross coil) type movement to eliminate engine noise transmitted through the meter cable hole on the fire wall and vibration of needle caused by cable failure. This layout is ideal for limited space available.

The bobbin type speedometer is an electromagnetic instrument in which two intersecting coils are wound around a permanent magnet rotor.

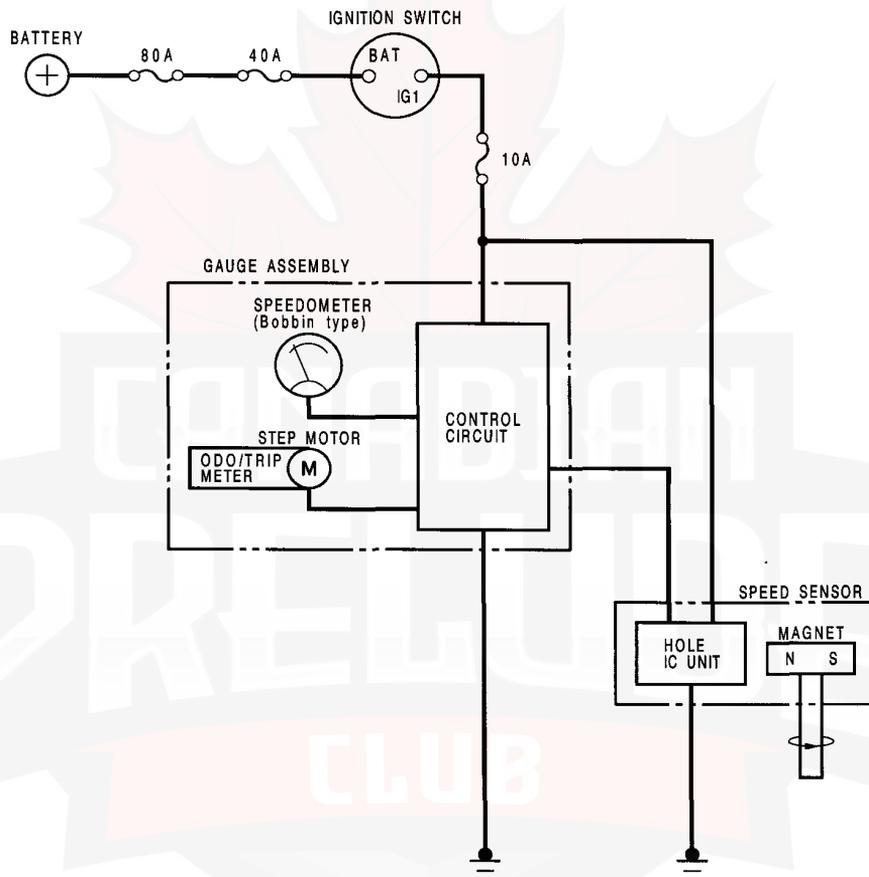

Gauge Assembly

Gauge/Terminal Locations Index

- **GAUGE ASSEMBLY**

Removal, page 16-9

Disassembly, page 16-8

- **ODOMETER**

Indicates 1 km [1 mile]

at 637 [1,026] revolutions of the speed sensor (4 pulse/rev).

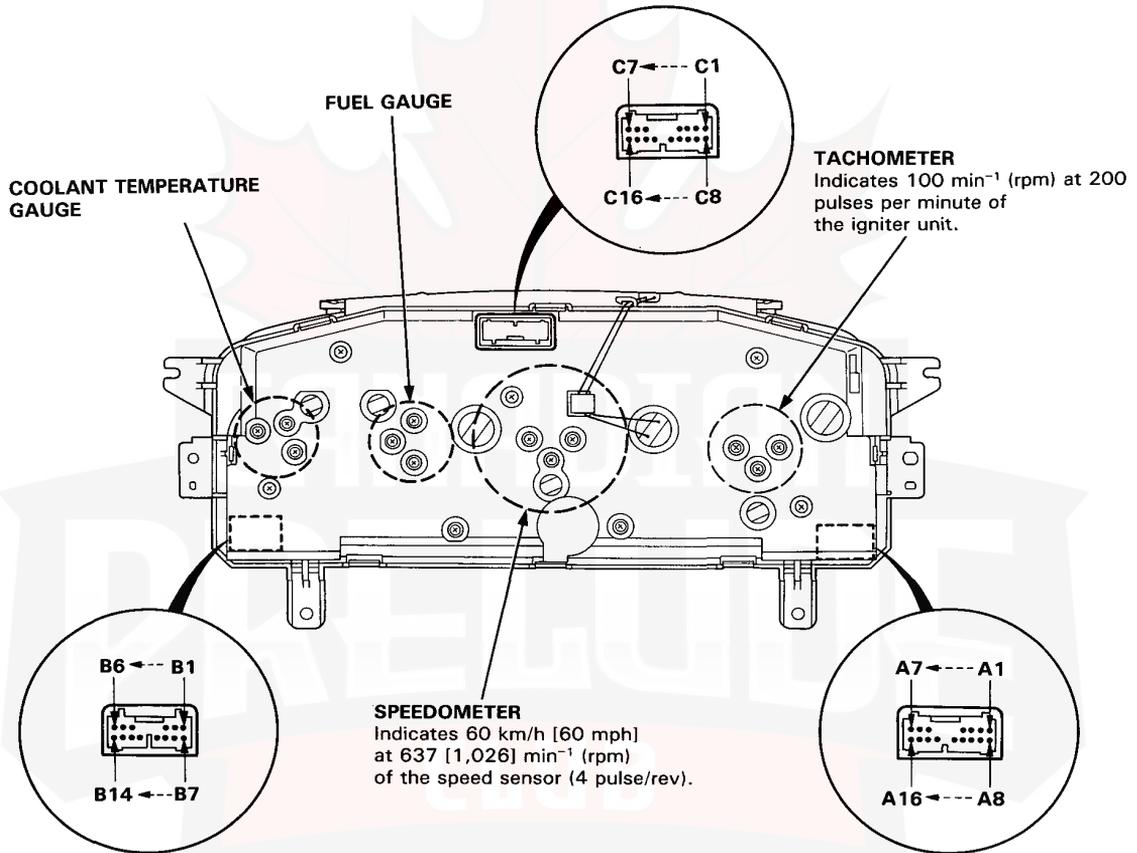



Bulb Locations

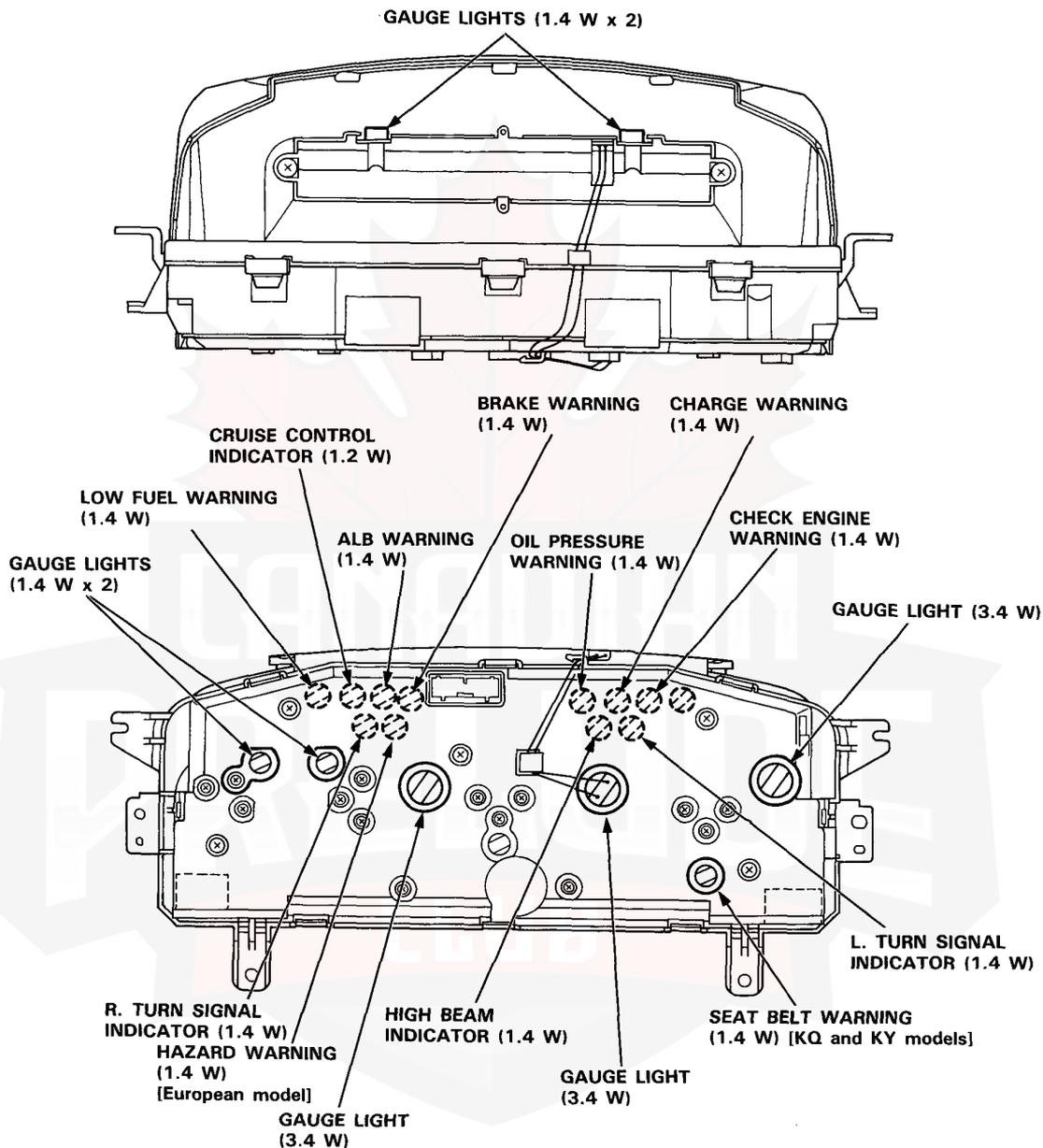

• SHIFT LEVER POSITION INDICATOR LIGHTS (1.12 W x 6)
on the main print panel (see page 16-8).

Gauge Assembly

Circuit Diagram

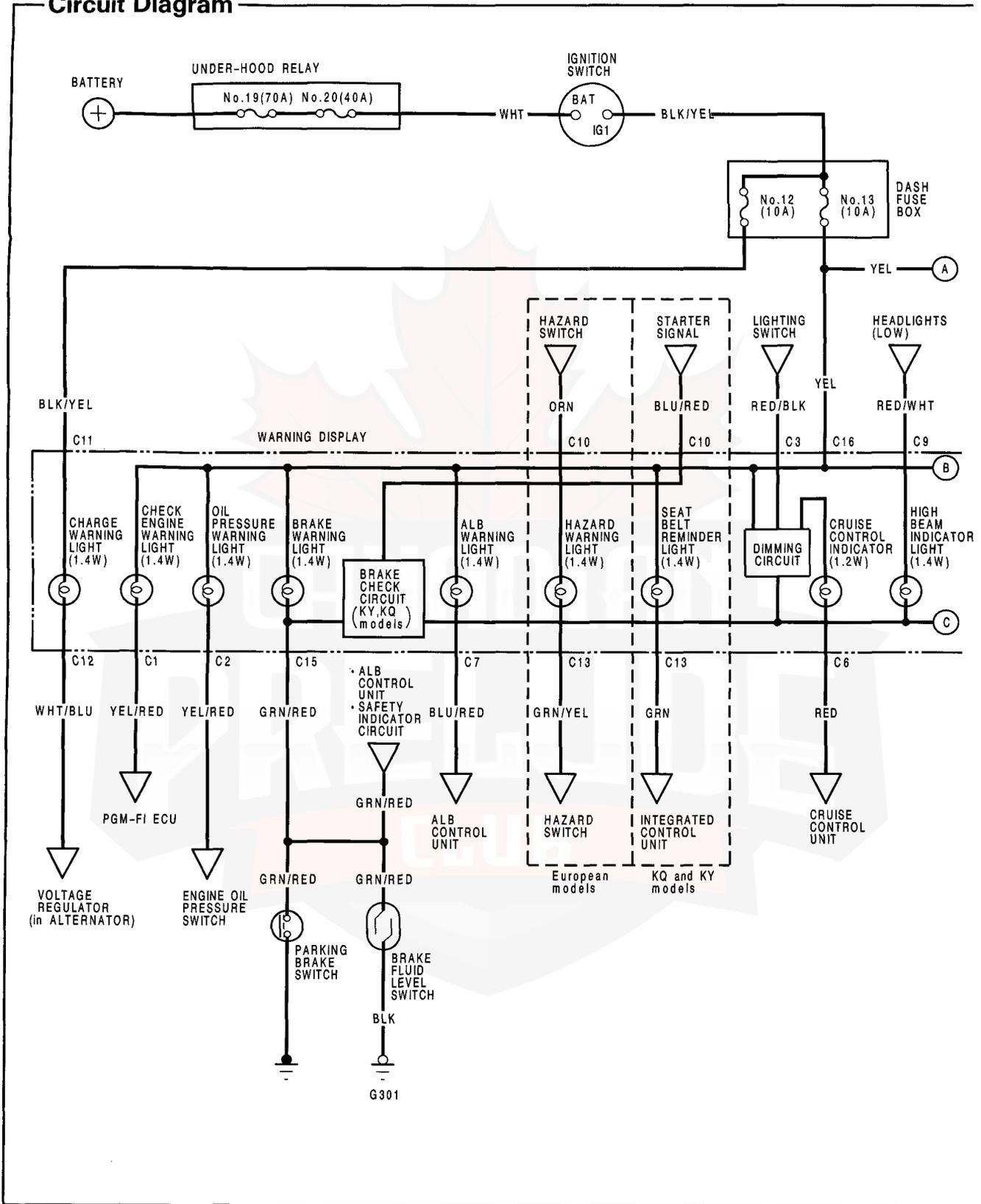

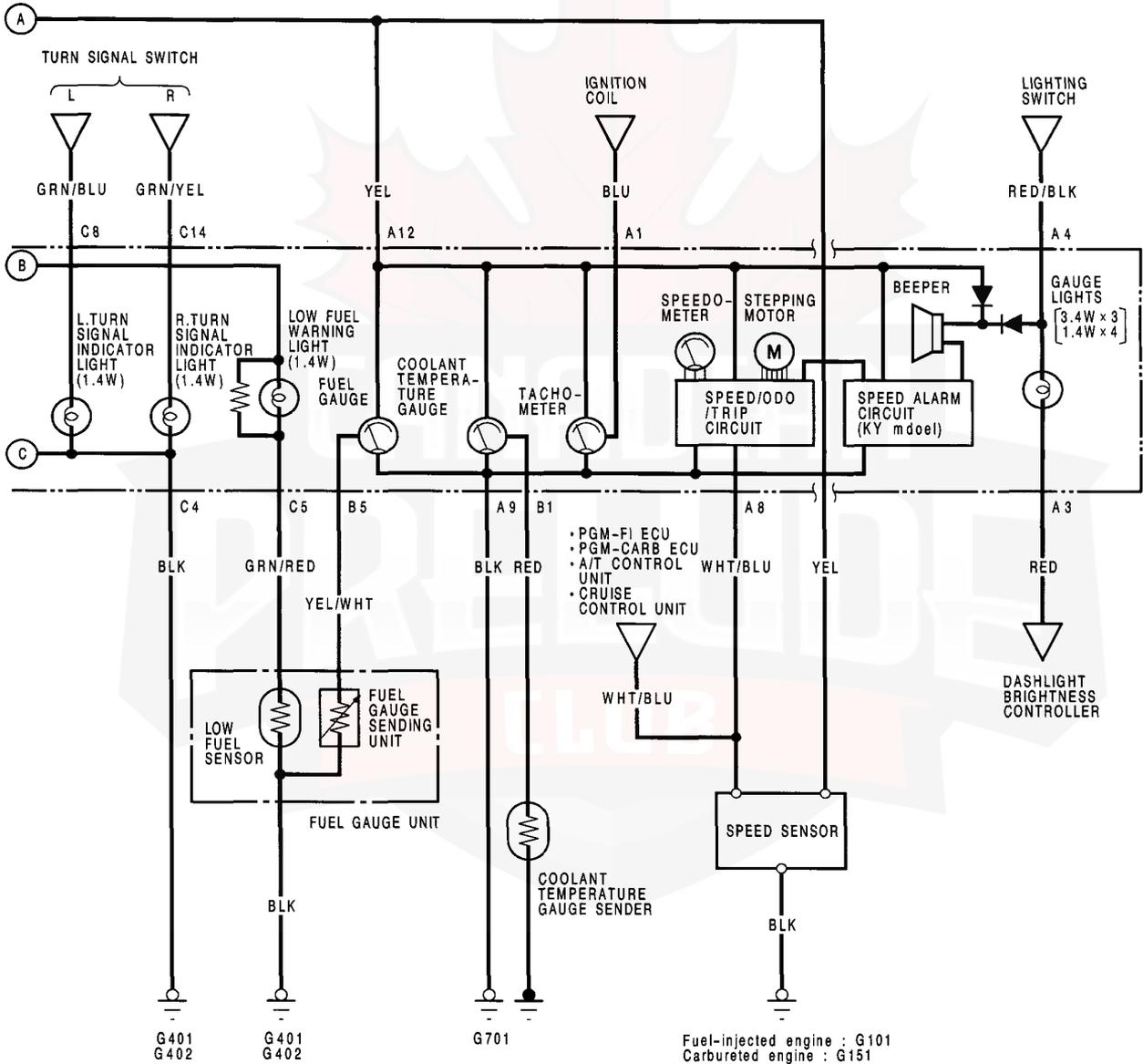

Gauge Assembly

Disassembly

NOTE: Handle the terminals and printed circuits carefully to avoid damaging them.

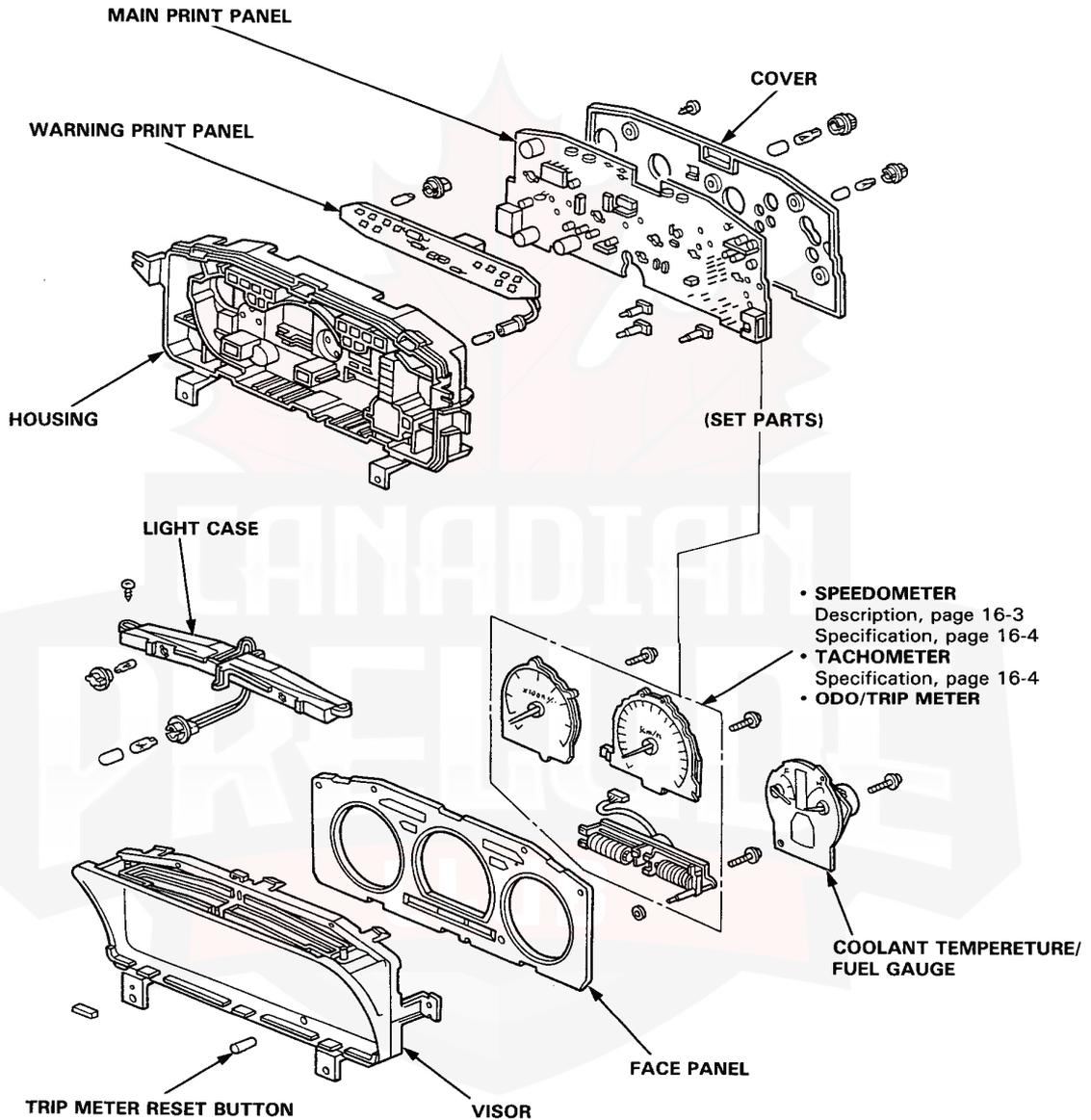



Removal

1. Remove the dashlight brightness controller and retractor/fog light switch from the instrument panel.

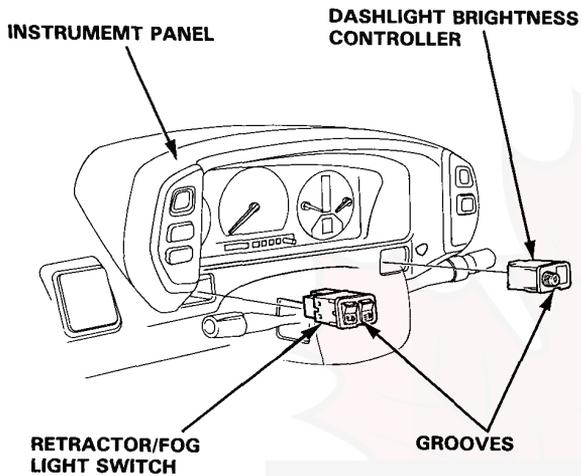

2. Remove the 5 screws, then remove the instrument panel from the gauge visor.

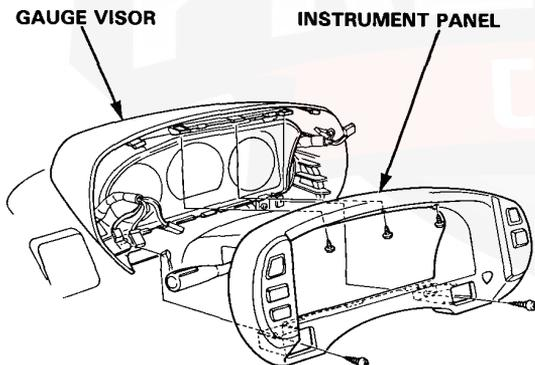

3. Remove the 4 screws and pull out the gauge assembly from the dashboard, then disconnect the connectors from the gauge assembly.

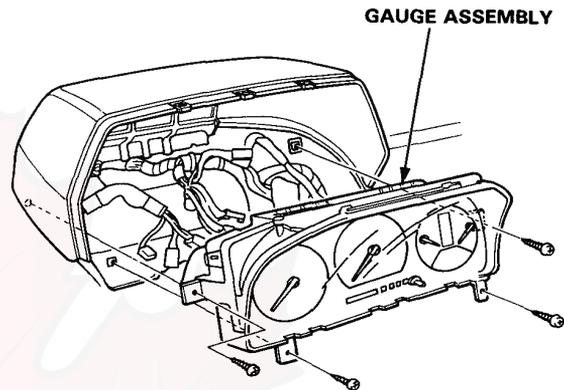

NOTE: Be carefull not to pinch the wires when installing the gauge assembly.

Gauge Assembly

Speed/Odo/Trip Meter Troubleshooting

NOTE: The numbers in the table show the troubleshooting sequence.

Item to be inspected Symptom	Blown No. 13 (10 A) fuse (in the dash fuse box)	NS		Speed sensor input test	Speed sensor is not installed correctly	Poor ground	Open circuit in wires or loose or disconnected terminals
		Main print panel	Odo/trip meter				
Speedometer does not operate.		2		1			WHT/BLU
Speedometer operates, but deflection error is great.		2			1		
Odo/trip meter does not operate.			1				
Speedometer and odo/trip meter do not operate.	1	3			2	G101 G151 G701	YEL or WHT/BLU

NOTE:

- The speedometer circuit is built in the main print panel assembly.
- Replace all of the main print panel, the tachometer, the speedometer and the odo/trip meter as a set if one of the above parts is defective.



Speed Sensor Input Test

NOTE: Check the No. 13 (10 A) fuse in the dash fuse box before testing.

1. Disconnect the 3-P connector from the speed sensor.

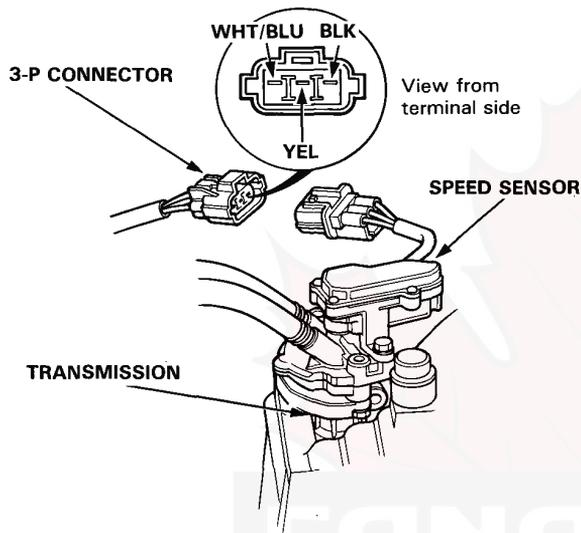

2. Check for continuity between the BLK terminal and body ground.
There should be continuity.
 - If there is no continuity, check for:
 - An open in the BLK wire.
 - Poor ground { Fuel-injected engine: G101
Carbureted engine: G151 }
 - If there is continuity, go to step 3.
3. Check for voltage between the YEL terminal and body ground with the ignition switch ON.
There should be battery voltage.
 - If there is no voltage, check for an open in the YEL wire.
 - If there is battery voltage, go to step 4.

4. Check for voltage between the WHT/BLU terminal and body ground with the ignition switch ON.
There should be approximately 5 V.
 - If there is no voltage, check for:
 - A8 terminal of gauge assembly (see page 16-4).
 - An open in the WHT/BLU wire.
 - If there is approximately 5 V, go to step 5.
5. If all continuity and voltage tests are normal, but the speedometer and the odo/trip meter do not operate, replace the speed sensor.

Gauge Assembly

Replacement

1. Disconnect the 3-P connector from the speed sensor.
2. Remove the mounting bolts and the speed sensor from the power steering speed sensor.

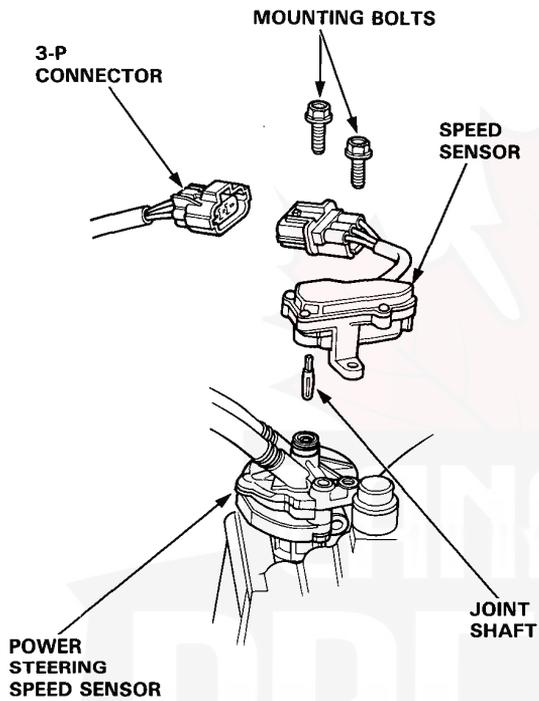

3. Install in the reverse order of removal.

NOTE: Be careful not to loose the joint shaft, for it is a tiny part.



Headlight Adjuster (KG model only)

Component Location Index

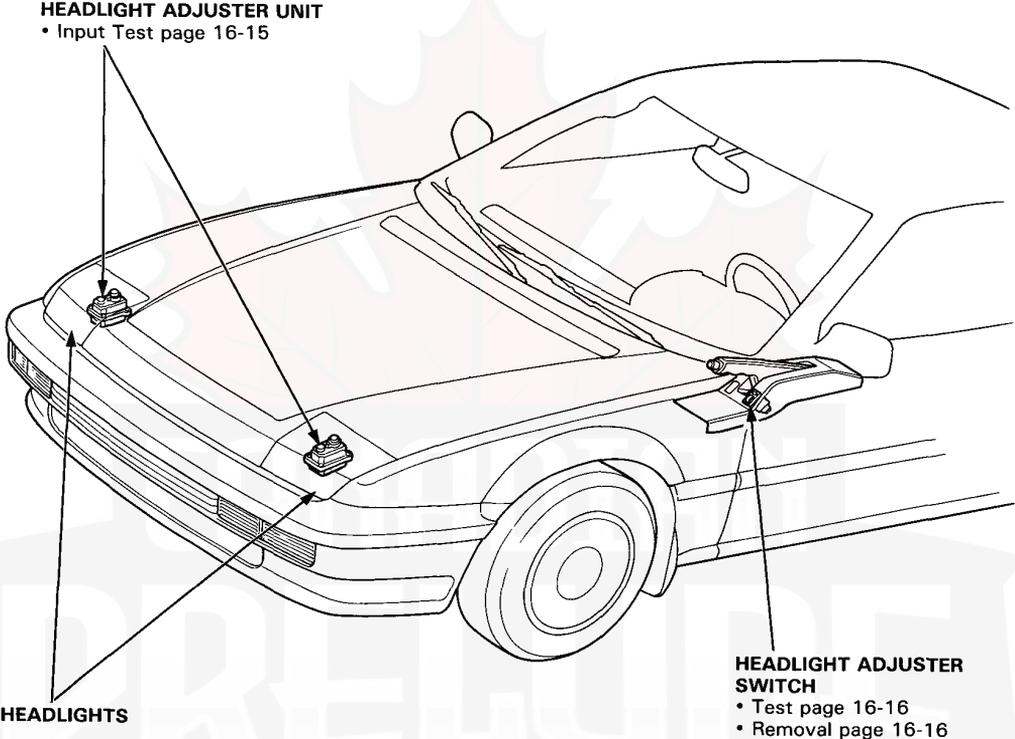

Headlight Adjuster (KG model only)

Circuit Diagram

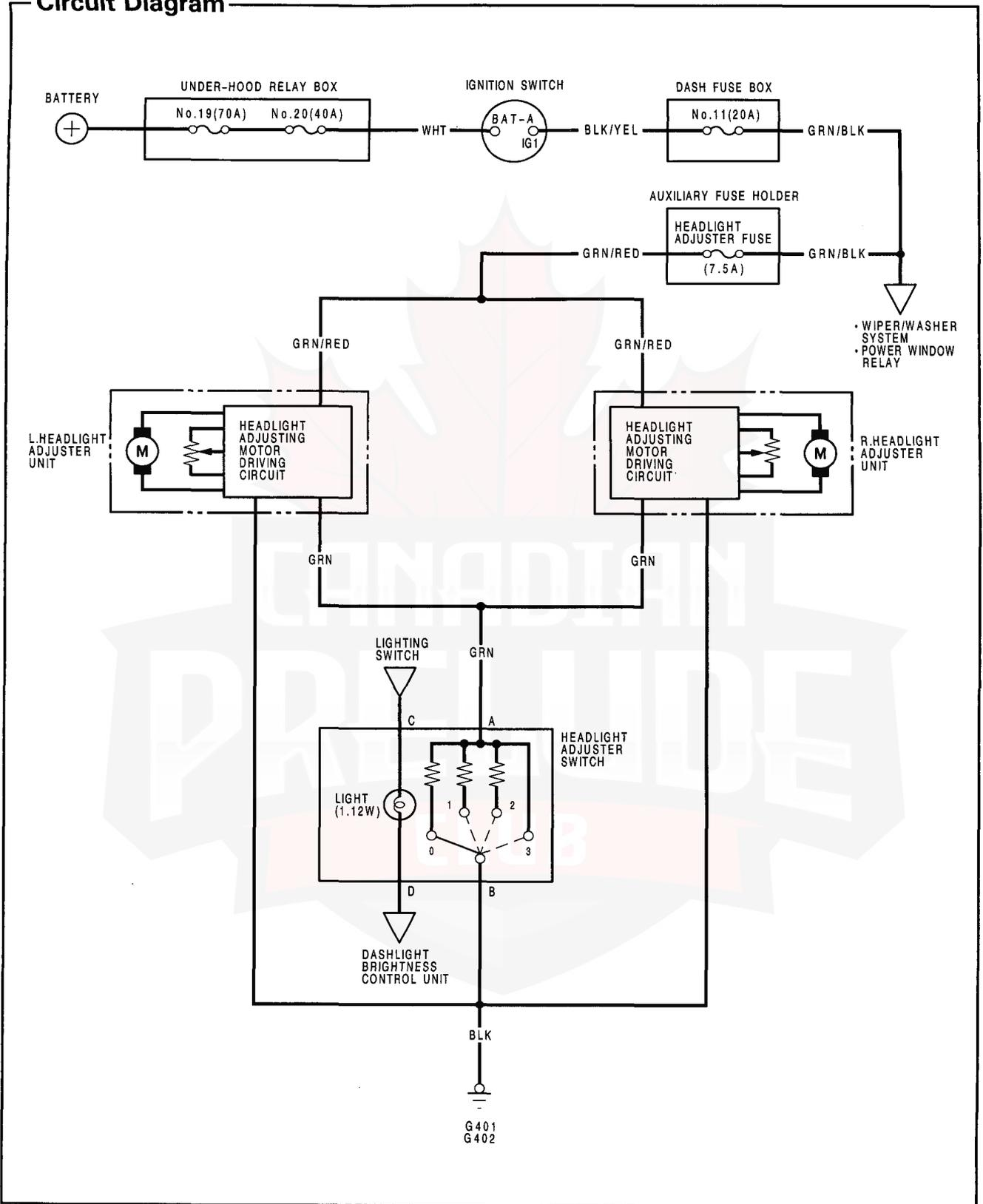



Input Test

NOTE: Check for blown headlight adjuster (7.5 A) fuse in the Auxiliary fuse holder before input test.

1. Disconnect the ground wire from the battery negative (-) terminal, then turn the knob clockwise to raise the headlight.

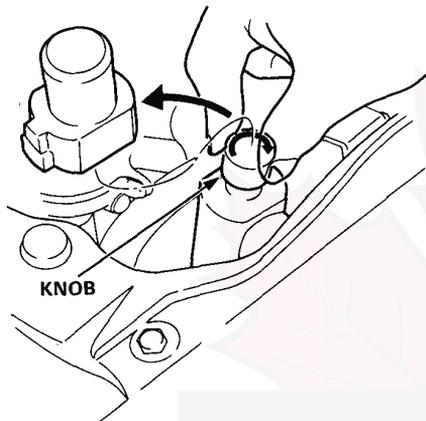

2. Remove the headlight.
3. Disconnect the 3-P connectors for the R and L headlight adjuster units.

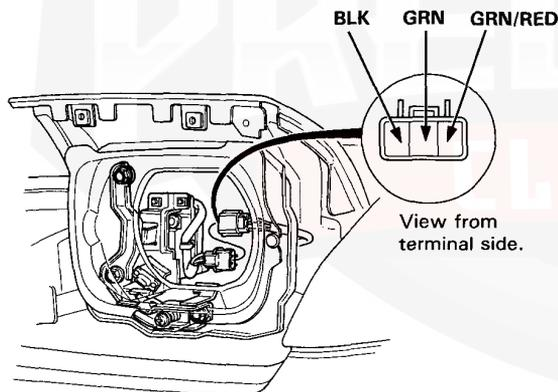

4. Check for continuity between the BLK terminal and body ground.
There should be continuity.
 - If there is no continuity, check for
 - An open in the BLK wire
 - Poor ground (G401, G402)
 - If there is continuity, go to step 3.
5. Check for voltage between the GRN/RED terminal and body ground with the ignition switch ON.
There should be battery voltage.
 - If there is no voltage, check for an open in the GRN/RED wire.
 - If there is battery voltage, go to step 4.
6. Using an ohmmeter, measure resistance between the GRN terminal and body ground in each adjuster switch position according to the table.

Position	Resistance (Approx. k Ω)
0	1.4
1	0.5
2	0.1
3	0

- If resistance is not within specification, check for
 - An open in the GRN wire.
 - Faulty headlight adjuster switch.
 - If resistance is within specification, go to step 5.
7. If all tests are normal, but the headlight adjuster unit does not operate, check for frozen, stuck or improperly installed the headlight adjuster unit. If mechanical check is OK, replace the headlight adjuster unit.

NOTE: Check for connection of 3-P connectors after test. For example, malfunction of headlight adjuster is occurred by improper connection of one side.

Headlight Adjuster (KG model only)

Switch Removal

1. Carefully pry out the headlight adjuster switch from the floor console.

NOTE: Be careful not to damage the switch or floor console when prying out the switch.

2. Disconnect the 4-P connector from the switch.

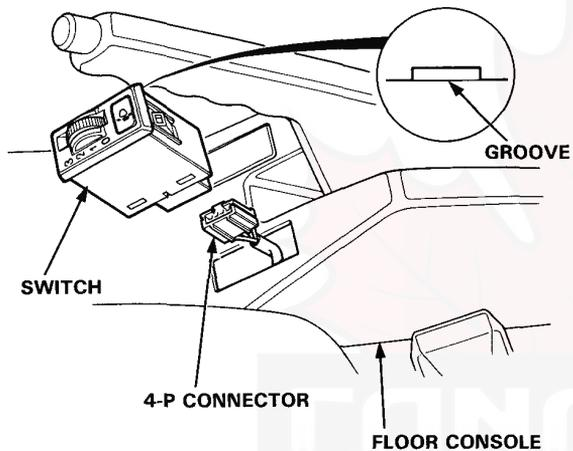

Switch Test

1. Remove the switch from the floor console.
2. Measure the resistance between the A and B terminals at 0, 1, 2 and 3 positions by moving the knob.
Replace the switch if the resistance is not within specifications.

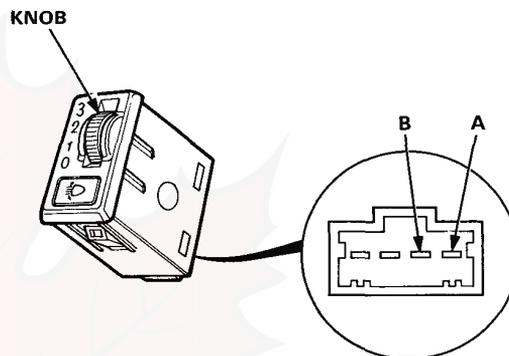

Knob Position	0	1	2	3
Resistance Approx. ($k\Omega$)	1.4	0.5	0.1	0



Fog Light

Circuit Diagram

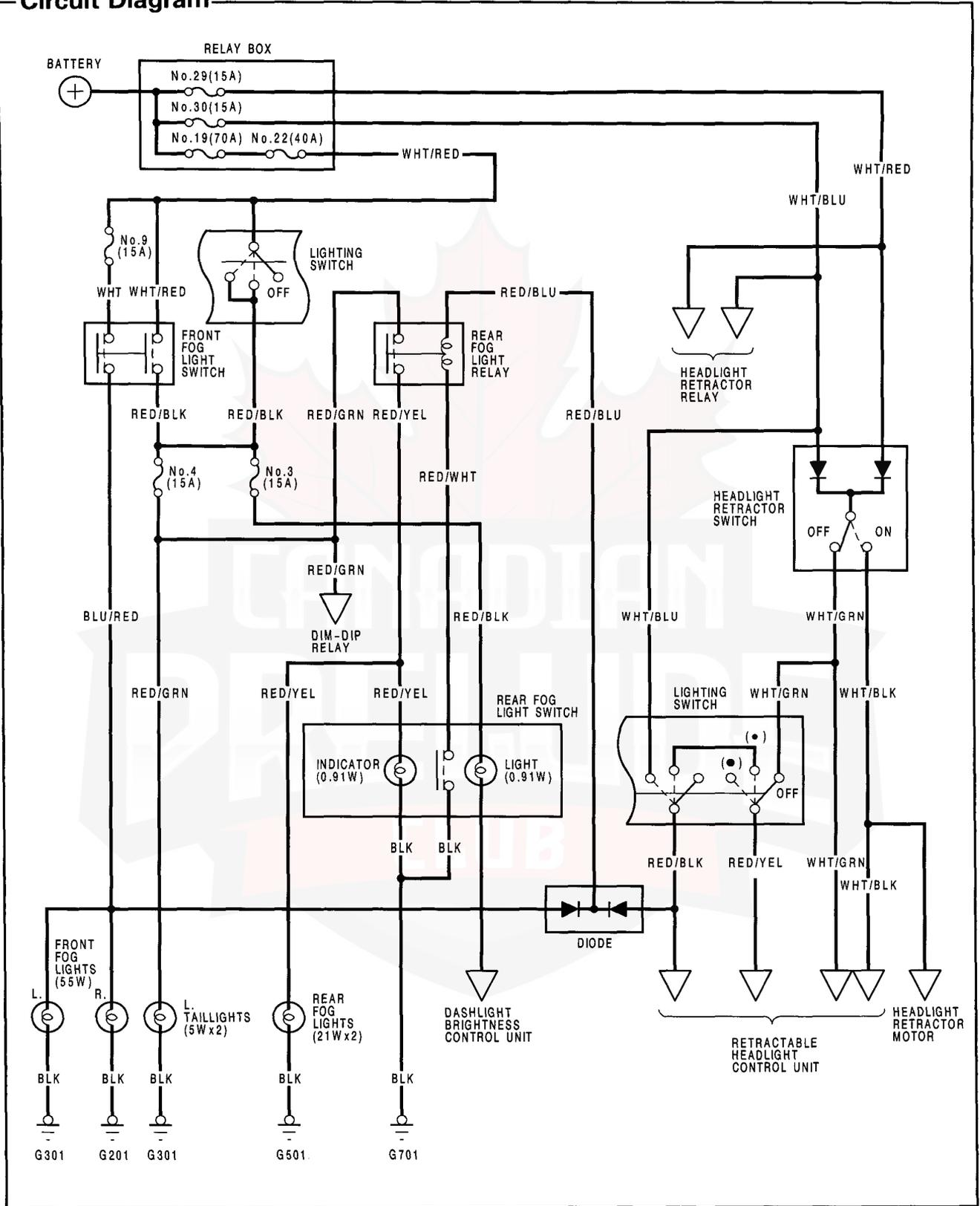

Fog Lights

Replacement

1. Remove the front marker/front turn signal light.

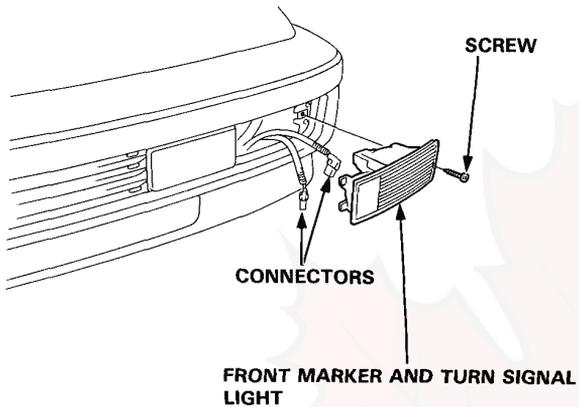

2. Remove the 4 screws from the bracket.
CAUTION: Do not loosen adjust screw.

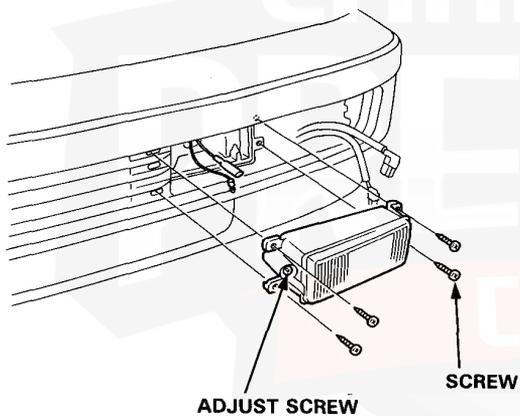

3. Pull out the fog light from the case, then disconnect the connectors from behind the fog light.

4. Remove the retaining spring and the bulb.

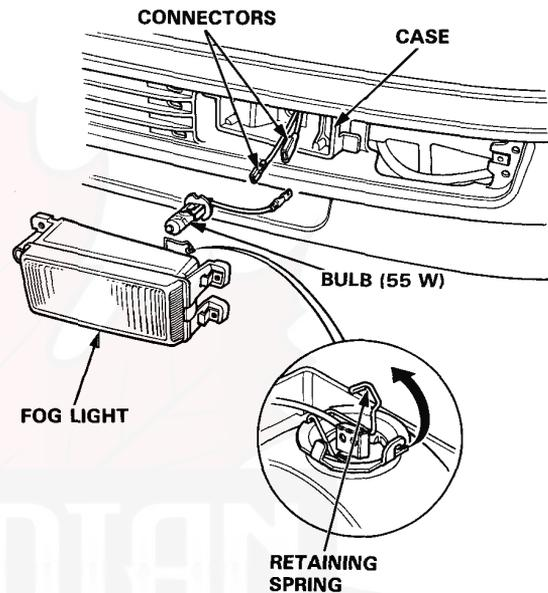

5. Install the fog light in reverse order of removal.



Adjustment

NOTE: Adjust the fog light to local requirements.

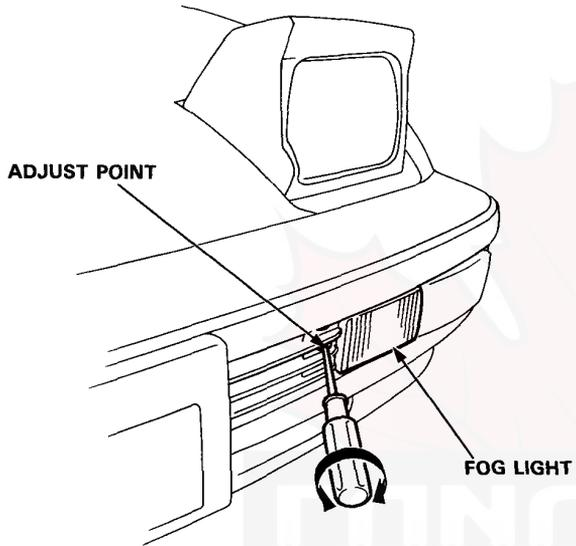

High Mount Brake Light (Rear Spoiler)

Circuit Diagram

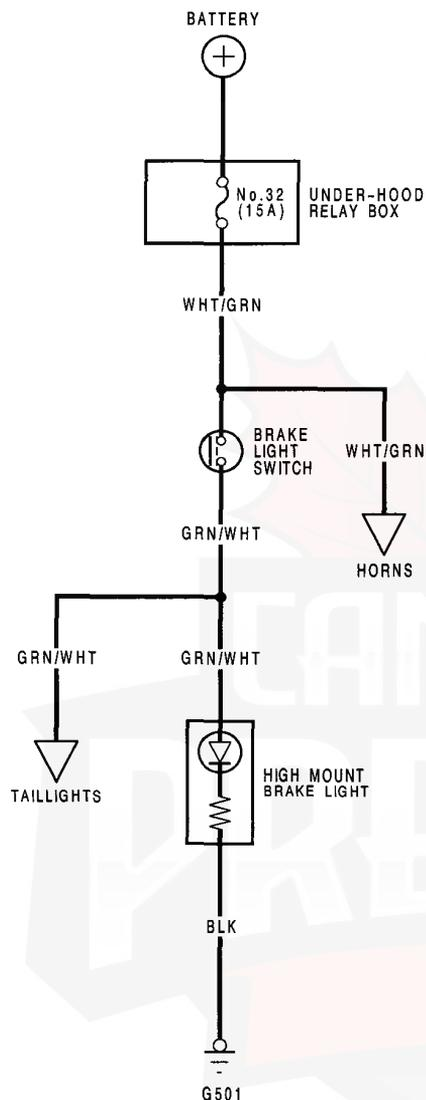

Test

NOTE: If a part of high mount brake light LED do not go on, replace the high mount brake light assembly.

1. Open the trunk lid.
2. Disconnect the 2-P connector from the high mount brake light.
3. Connect voltmeter positive probe to the GRN/WHT terminal, negative probe to BLK terminal. When the brake pedal is pushed, check for voltage between GRN/WHT and BLK terminals. There should be voltage.
 - If there is no voltage, check for
 - Blown No. 32 (15 A) fuse in the under-hood relay box.
 - An open in the GRN/WHT or BLK wire.
 - If there is battery voltage, go to step 4.
4. Connect the 2-P connectors to the high mount brake light. When the brake pedal is pushed, check go on all LED of high mount brake light.
 - If the high mount brake light do not go on, check for open the wires in the rear spoiler. If the wires in the rear spoiler OK, replace the high mount brake light.

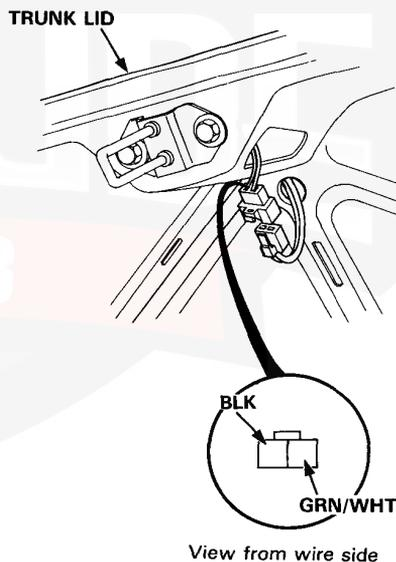



Replacement

CAUTION: Be careful not to damage the high mount brake light, rear spoiler and trunk lid.

1. Loosen the 2 screws on the rear spoiler, then push the screwheads using a screw driver.
2. Remove the 2 screws from the rear spoiler.

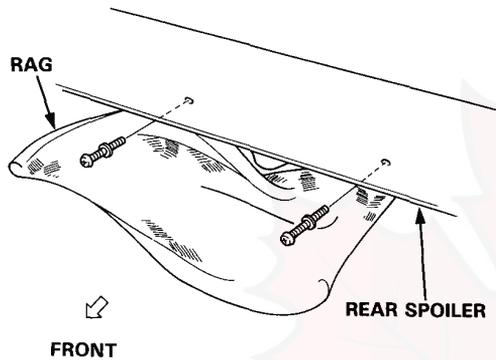

3. Carefully push out the high mount brake light from behind the rear spoiler, then disconnect the connectors from the high mount brake light.

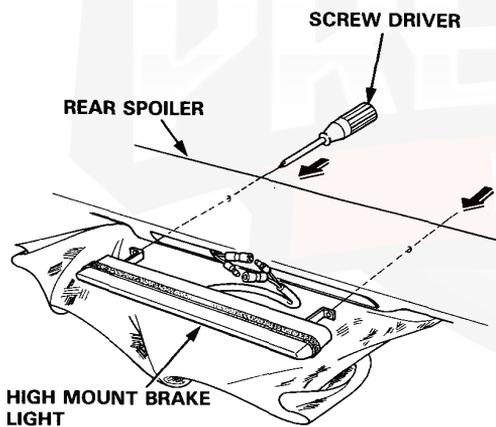

Cigarette Lighter

Component Location Index

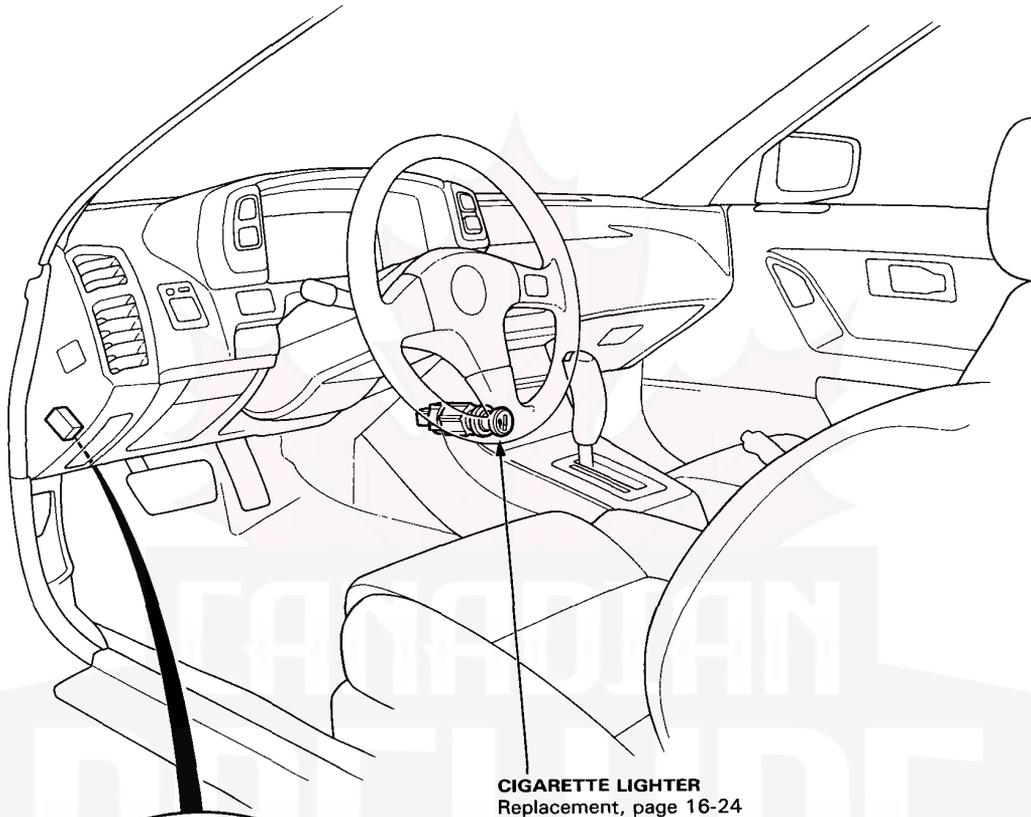

CIGARETTE LIGHTER
Replacement, page 16-24

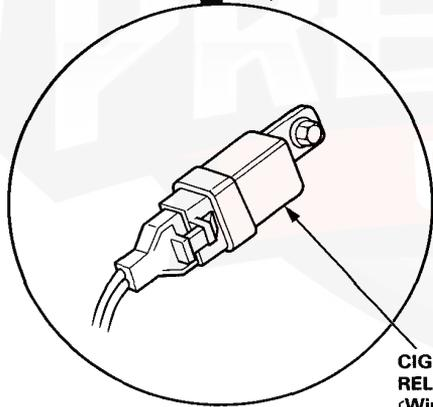

**CIGARETTE LIGHTER
RELAY**
{ Wire colors: WHT/BLU, WHT/BLU }
YEL/RED and BLK
Test, page 16-24

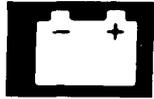

Circuit Diagram

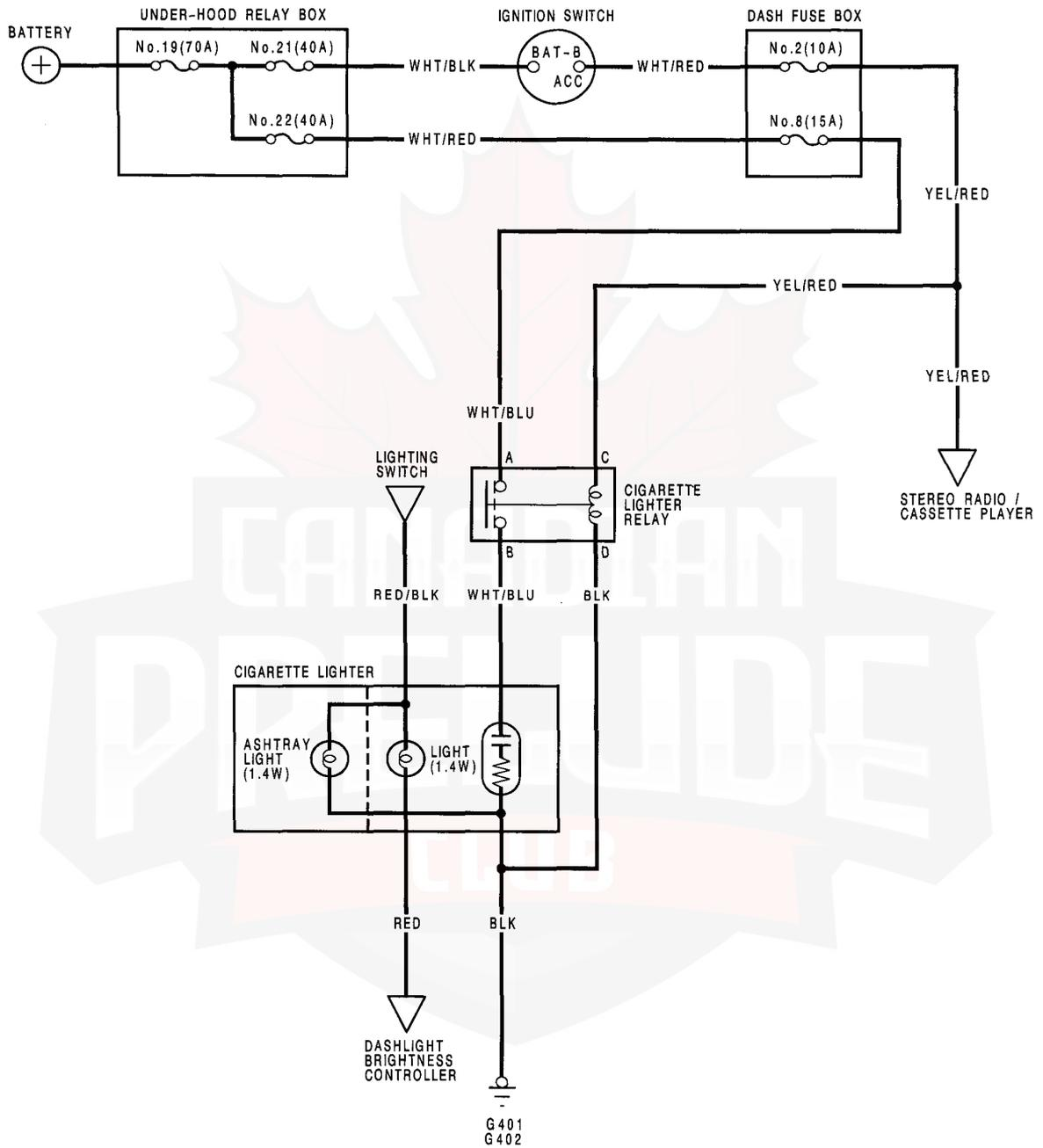

Cigarette Lighter

Replacement

1. Remove the floor console.
2. Disconnect the 4-P connector and remove the ashtray light.
3. Disconnect the thermofuse case from the socket end.
4. Remove the ring nut and separate the cigarette lighter socket from the thermal protector.

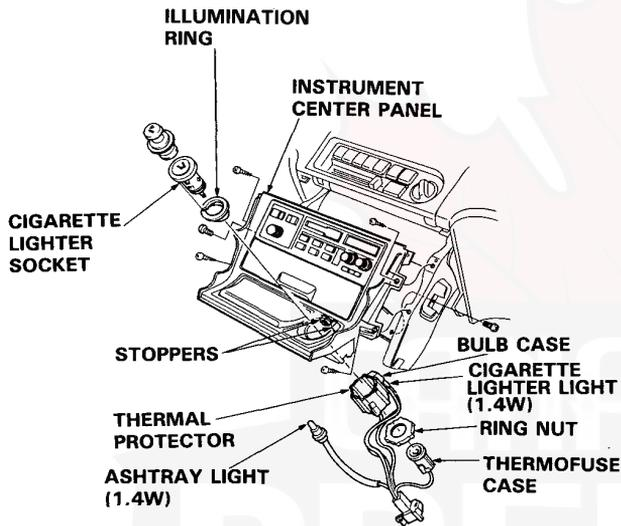

5. When installing the cigarette lighter, align each lug on the face panel, illumination ring and the cigarette lighter socket with the slot in the hole, then position the bulb case on the thermal protector between the stoppers of the center panel.
6. Make sure that the ground wire, bulb socket and thermofuse case are seated to the cigarette lighter assembly.

Relay Test

1. There should be continuity between the A and B terminals when the battery is connected to the C and D terminals. There should be no continuity when the battery is disconnected.

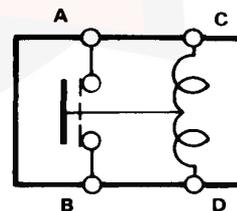
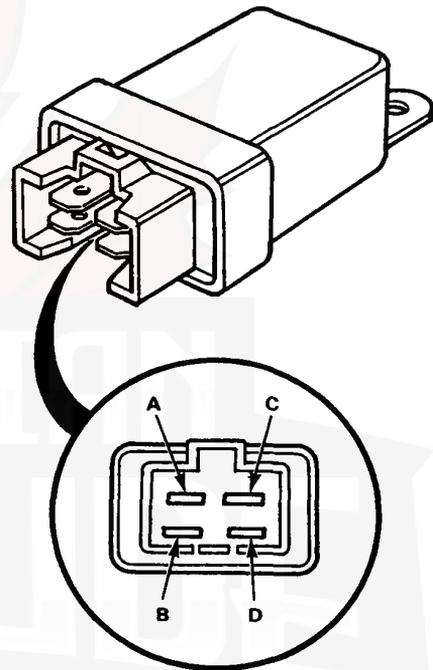

Power Antenna Motor (With Mast Antenna Retractor Relay)



Circuit Diagram

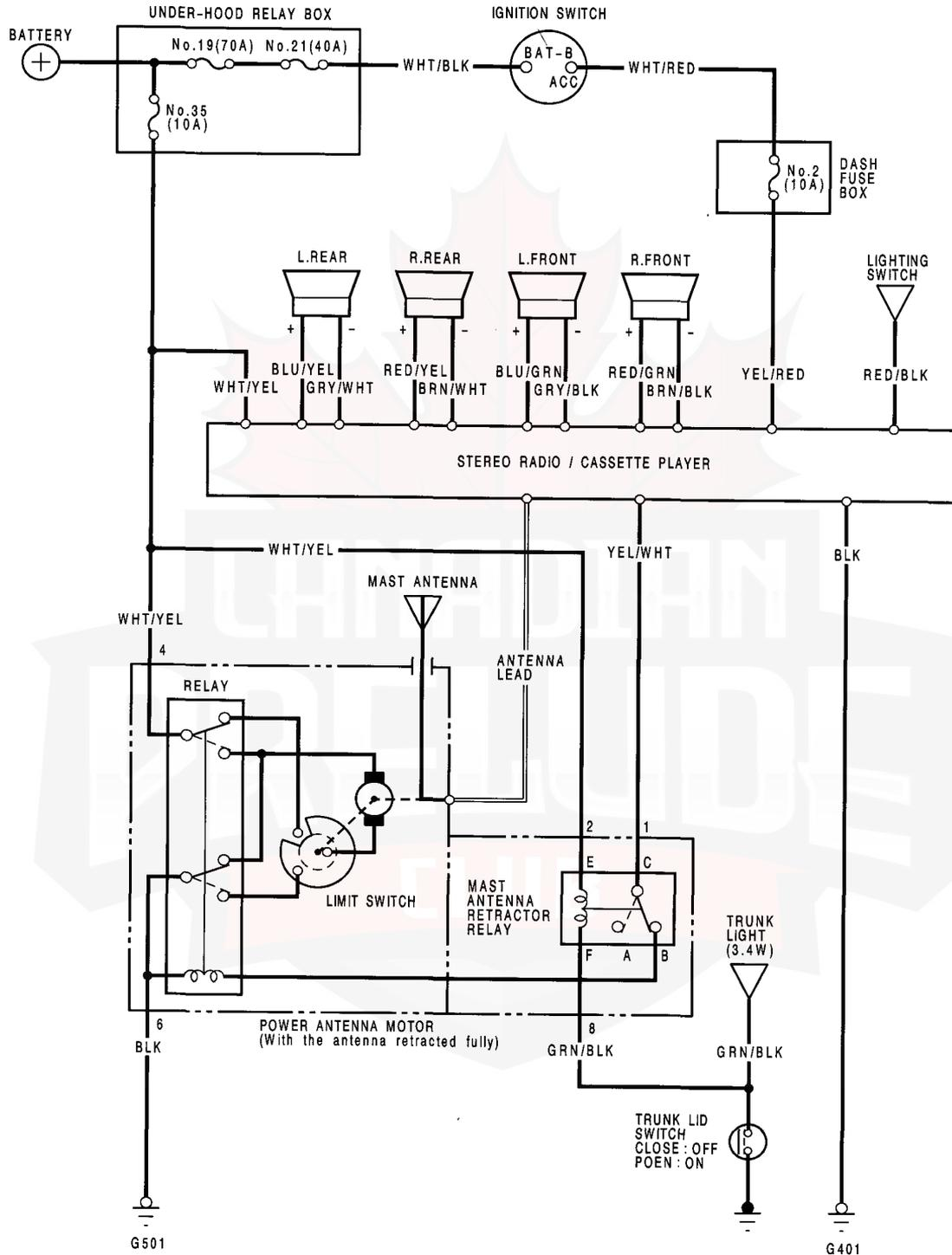

Power Antenna Motor (With Mast Antenna Retractor Relay)

Motor Test

1. Remove the trunk side trim panel.
2. Disconnect the 10-P connector from the motor and remove the connector from its clamp.
3. First check power to the motor at the harness pins: There should be battery voltage between the WHT/YEL¹, WHT/YEL² (+) and BLK (-) terminals all the time. There should be battery voltage between the YEL/WHT (+) and BLK (-) terminals only with the ignition and radio switched ON.
 - If there is no voltage, check for
 - Blown No.35 (10 A) fuse in the relay box or No.2 (10 A) fuse in the dash fuse box.
 - An open in the WHT/YEL¹, WHT/YEL² or YEL/WHT wire.
 - Poor ground (G501).
 - If there is battery voltage, go to step 4.
4. Test motor operation:

FULL EXTEND: Connect battery positive to the No.1 and No.4 terminals and negative to the No. 6 terminal.

RETRACTED: Connect battery positive to the No.1, No.2 and No.4 terminals and negative to the No. 6 and No. 8 terminals.
5. If the motor fails to operate properly, remove the mast antenna retractor relay from the motor antenna and check the mast antenna retractor relay.

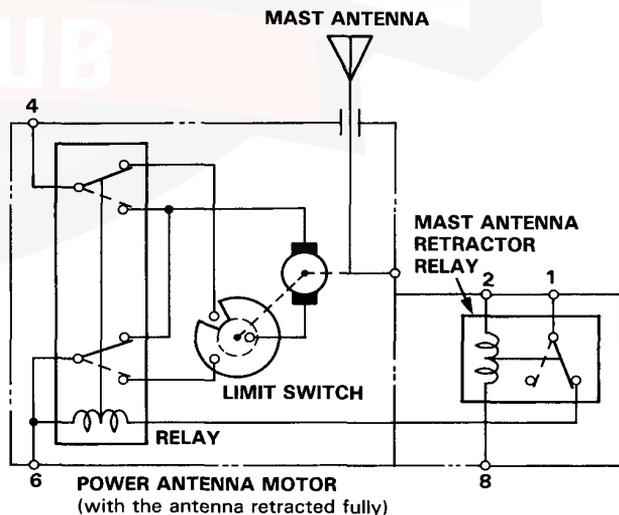
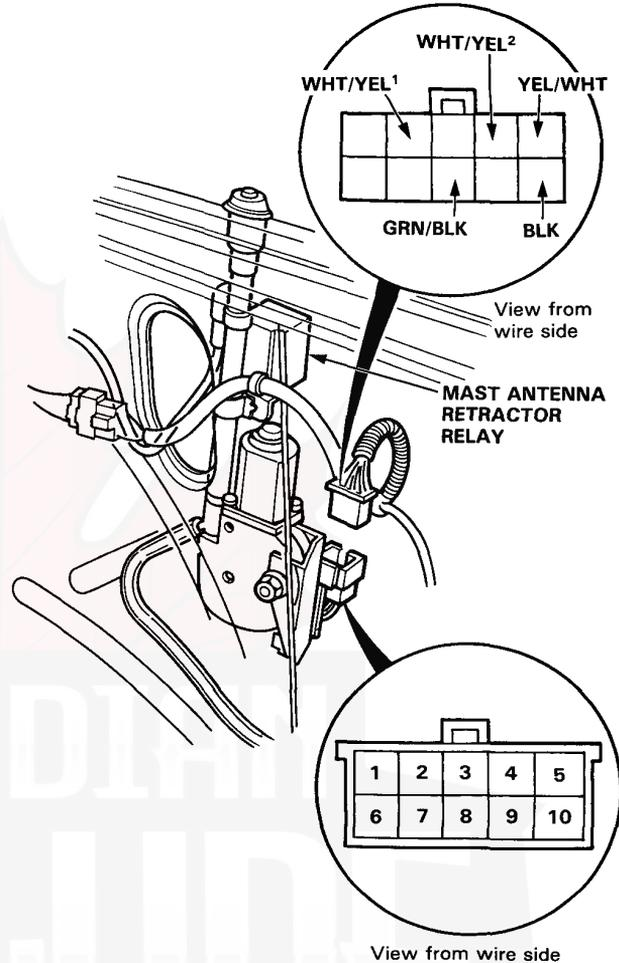



Relay Test

There should be continuity between the A and C terminals when the battery is connected to the E and F terminals.

There should be continuity between the B and C terminals when the battery is disconnected.

